



NAKSHM SURGICAL

nakshmsurgical@gmail.com



SURGICAL INSTRUMENTS CATALOGUE



Table Of Contents













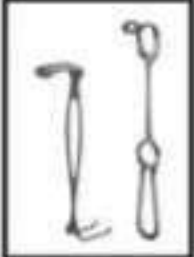
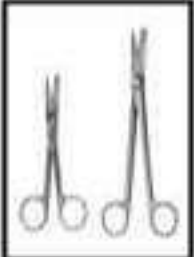

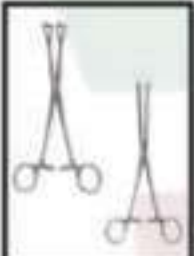

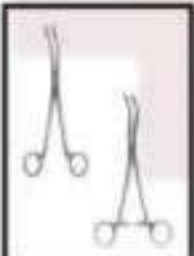
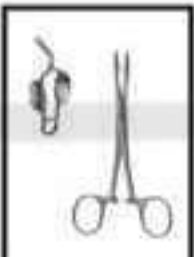

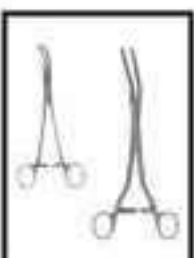

Diagnostic, Anaesthesia and other instruments Diagnostyka, Anestezjologia, Narzędzia różne	Page Seite 1 - 10		Probes, Pocket Instruments sets Zgłębniki i zestawy narzędzi	Page Seite 66 - 68	
Scalpels, knives and Scalpel Handles Skalpele, nożyki i uchwyt do skalpeli	11 - 14		Wound Retractors Haki do ran	69 - 80	
Scissors Nożyczki	15 - 31		Self-Retaining Retractors, Abdominal Retractors Haki samo trzymające, haki brzuszne	81 - 85	
Dissecting-and Tissue Forceps Pincety preparacyjne i chirurgiczne	32 - 42		Abdominal Surgery Intestinal-and Rectal Instruments Chirurgia brzuszna, narzędzia jelitowe i rektalne	86 - 93	
Sponge, Dressing and Tissue Grasping Forceps Towel Clamps Pincety do tamponowania, anatomiczne, Chirurgiczne chwytające, spinaki	43 - 48		Gall Bladder-, Liver-and Spleen Instruments Narzędzia do kamieni żółciowych, wątroby, śledziony	94 - 96	
Vessel Clips, Bulldog Clamps Haemostatic Forceps Zaciski do naczyń, klamry typ Bulldog, Kleszczyki naczyniowe	49 - 57		Genito-Urinary Instruments and Trocars Narzędzia urologiczne, trokary	97 - 100	
Ligature, Hysterectomy and Compression Forceps Vaginal Clamps Narzędzia do ligatury Narzędzia do macicy, kleszcze ściskające, kleszcze dopochwowe	58 - 60		Vaginal Specula and Uterine Dilators Wzierniki ginekologiczne i rozszerzacz	101 - 106	
Needle Holders, Suture Instruments Iglotrzymacze, narzędzia do szycia	61 - 65		Uterine Probes, Uterine Dressing-, Polypus-and Ovum Forceps Zgłębniki maciczne, kleszczyki do polipów i jajczek	107 - 109	



Table Of Contents

	Page Seite		Page Seite	
Biopsy Instruments and Curettes				Suction Instruments
Narzędzia biopsyjne, łyżeczki	110 - 116			Narzędzia ssące
				158 - 166
Obstetrics and Tracheotomy				
Polożnictwo i tracheotomia	117 - 119			
Cardiovascular-and Thoracic Surgery				
Chirurgia naczyniowa i torakochirurgia	120 - 128			
Bone Punches, Rongeurs				
Przebijaki kostne i odgryzacze	129 - 134			
Elevators, Bone Levers, Raspatories, Bone Files, Bone Curettes				
Podważki, dźwignie, skrobaczki, pilniki, łyżeczki kostne	135 - 139			
Mallets, Chisels and Gouges				
Młotki, dłuta, dłuta wklęsłe	140 - 141			
Bone Holding Forceps, Bone Rongeurs, Bone Cutting Forceps				
Kleszcze do kości, kleszcze tnące	142 - 146			
Plaster Instruments				
Narzędzia do gipsu	147 - 157			



Percussion Hammers and Aesthesiometers



01-101
TROEMNER
Size: 245 mm



01-102
DEJERINE
Size: 200 mm



01-103
DEJERINE
with needle
Size: 210 mm



01-104
TAYLOR
Size: 195 mm



01-105
BERLINER
Size: 200 mm



01-106
BUCK
with needle
and brush
Size: 180 mm



01-107
RABINER
with needle
and brush
Size: 255 mm



01-108
ALY
Size: 190 mm



01-109
WARTENBERG
Pinwheel for
neurological
examination
Size: 185 mm



Stethoscopes



01-110
PINARD (Aluminum)
Size: 155 mm

1/2



01-111
wooden
Size: 145 mm

1/2



01-112
BOWLES
Stethoscope
with diaphragm

1/2



01-113
ANESTOPHON

1/2



01-114
FORD-BOWLES
Dual chest piece
with two outlets

1/2



01-115
BOWLES

1/2



Head Mirrors and Head Bands



01-116
ZIEGLER \varnothing 90mm
head mirror only
with rubber coating



01-117
ZIEGLER \varnothing 90mm
head mirror only
with metal coating



01-118
ZIEGLER
head band of plastic black

01-119
ZIEGLER
head band of plastic white



01-120
MURPHY
head band of celluloid, white



01-121
head band of plastic,
white, soft pattern



01-122
head mirror with black
plastic head band.



Tongue Depressors





Instruments for Anaesthesia and Tongue Forceps



1/2
01-134
SCHIMMELBUSCH
Ether mask



1/2
01-135
HEISTER
Mouth gag
Size: 130 mm



1/2
01-136
FERGUSSON-ACKLAND
Mouth gag
Size: 145 mm



1/2
01-137
DENHARDT
Mouth gag with silicon
inserts, interchangeable
Size: 125 mm



1/2
01-138
ROSER KOENIG
Mouth gag
Size: 160 mm, 185 mm



1/2
01-139
YOUNG
Size: 165 mm



1/2
1 Pair Of
Rubber Pads

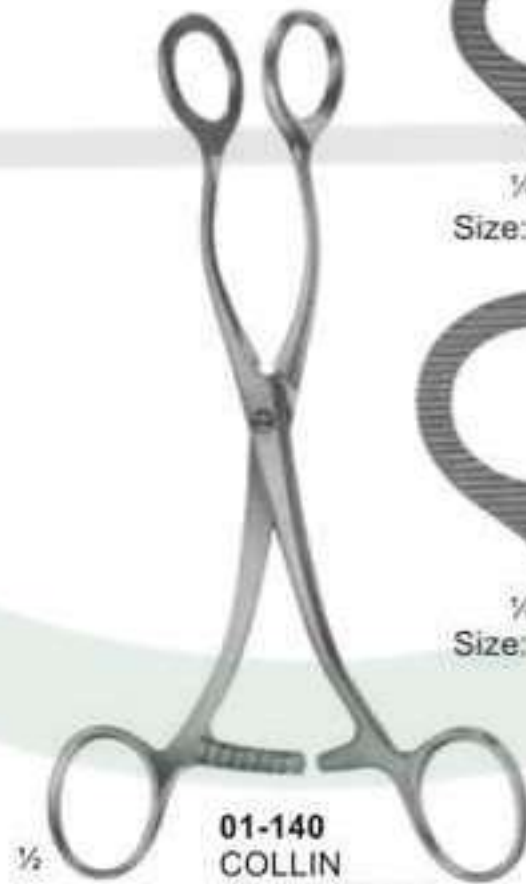

1/2
01-140
COLLIN
Size: 160 mm,
170 mm



1/2
Size: 160 mm



1/2
Size: 170 mm



1/2
01-141
HEYWOOD-SMITH
modif. Size: 215 mm



Blood Lancets and Laryngeal Mirrors

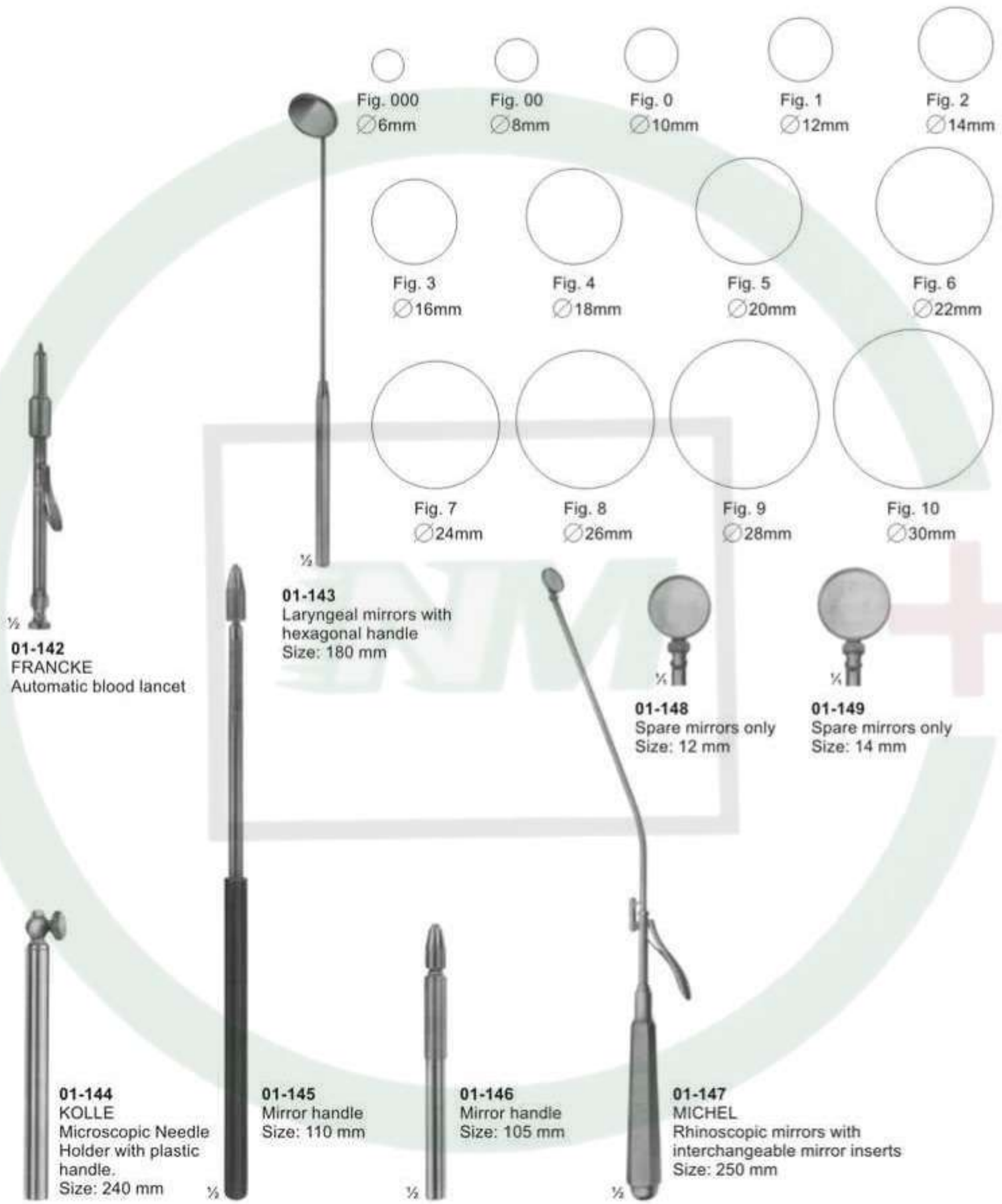



Diagnostic Sets



01-153
Ophthalmoscope



$\frac{1}{4}$
01-150
Infants
Size: 150 mm

$\frac{1}{4}$
01-151
Children
Size: 200 mm

$\frac{1}{4}$
01-152
Adults
Size: 250 mm

$\frac{1}{2}$
01-150 - 152
MAGILL
Catheter Introducing Forceps



01-154
Otoscope & Pouch



$\frac{1}{2}$
01-153-A
Medium battery handle
only, 25 mm diam.



01-153-B
Spare bulb
2.7 volt, for
otoscopes



01-153-C
Spare bulb
2.6 volt, for
ophthalmoscopes



01-155
ENT Set



01-156
ENT Set
Otoscope, consists of
battery handle without batteries,
3 ear specula, 1 bulb in velvet lined case



01-157
Otoscope Set with three specula.



Laryngoscopes



01-158
MILLER
Laryngoscope set, consists of battery handle (without battery)
with five miller laryngoscope blades



Fig. 0 Working Length, 55 mm (Baby's)
Fig. 1 Working Length, 80 mm (Children's)
Fig. 2 Working Length, 130 mm (Adolescent's)
Fig. 3 Working Length, 170 mm (Women's)
Fig. 4 Working Length, 180 mm (Men's)



01-159
GUEDEL-NEGUS
Laryngoscope set, consists of battery handle (without battery)
with four miller laryngoscope blades



Fig. 1 Working Length, 70 mm (Children's)
Fig. 2 Working Length, 90 mm (Adolescent's)
Fig. 3 Working Length, 110 mm (Women's)
Fig. 4 Working Length, 135 mm (Men's)



Laryngoscopes



01-160
McINTOSH
Laryngoscope Set, Consists Of Battery Handle (Without Battery)
With Three McIntosh Blades, Fig. 1, Fig. 2, Fig. 3

01-161
McINTOSH
Laryngoscope Set, Consists Of Battery Handle (Without Battery)
With Five McIntosh Blades, Fig. 0, Fig. 1, Fig. 2, Fig. 3, Fig. 4



01-162
FOREGGER
Laryngoscope Set, Consists Of Battery Handle (Without Battery)
With Three Foregger Blades,
Fig. 1, Fig. 2, Fig. 3,

01-163
FOREGGER
Laryngoscope Set, Consists Of Battery Handle (Without Battery)
With Four Foregger Blades,
Fig. 1, Fig. 2, Fig. 3, Fig. 4,



01-161 A Fig. 0 Working Length, 55 mm (Baby's)
01-161 B Fig. 1 Working Length, 75 mm (Children's)
01-161 C Fig. 2 Working Length, 90 mm (Adolescent's)
01-161 D Fig. 3 Working Length, 110 mm (Women's)
01-161 E Fig. 4 Working Length, 135 mm (Men's)



01-162 A Fig. 1 Working Length, 70 mm (Children's)
01-162 B Fig. 2 Working Length, 90 mm (Adolescent's)
01-162 C Fig. 3 Working Length, 110 mm (Women's)
01-162 D Fig. 4 Working Length, 135 mm (Men's)



01-164
Fiber Optic
Battery Handle
30mm diam.



01-165
Fiber Optic
Battery Handle
18mm diam.



01-166
Replacement Lamp
(Krypton) 2.5 V



01-167
Replacement Lamp
(Halogen) 2.5 V



Examination & Measuring Instruments



01-168
Caliper Of Aluminium
Graduated in mm & inches
up to 180mm
Measuring Range up to 139mm



01-169
VERNIER
Universal Caliper Of Steel
Graduated in mm & inches
up to 180mm
Measuring Range up to 120mm
with Vernier in 1/10mm & 1/16"



01-170
CARROLL
Size: 145 mm
Finger Goniometer



01-171
TOWNLEY
Graduated in
mm & inches
Size: 115 mm



01-172
COLLIN
Druck Pressure 72 kg
Size: 125 mm



01-173
BERTILLON
Caliper For Measuring The Head
Size: 320 mm



01-174
CASTROVIEJO
Caliper
Size: 75mm



01-175
MOLTGEN
Goniometer



01-176
Size: 150 mm



01-177
Size: 500 mm



Dissecting Knives



02-101 - 110
Fig. 1 - 10



02-101
Fig. 1
30 mm



02-102
Fig. 2
36 mm



02-103
Fig. 3
40 mm



02-104
Fig. 4
45 mm



02-105
Fig. 5
50 mm



02-106
Fig. 6
27 mm



02-107
Fig. 7
35 mm



02-108
Fig. 8
40 mm



02-109
Fig. 9
47 mm



02-110
Fig. 10
50 mm



Amputating Knives, Cartilage Knives and Autopsy Knives

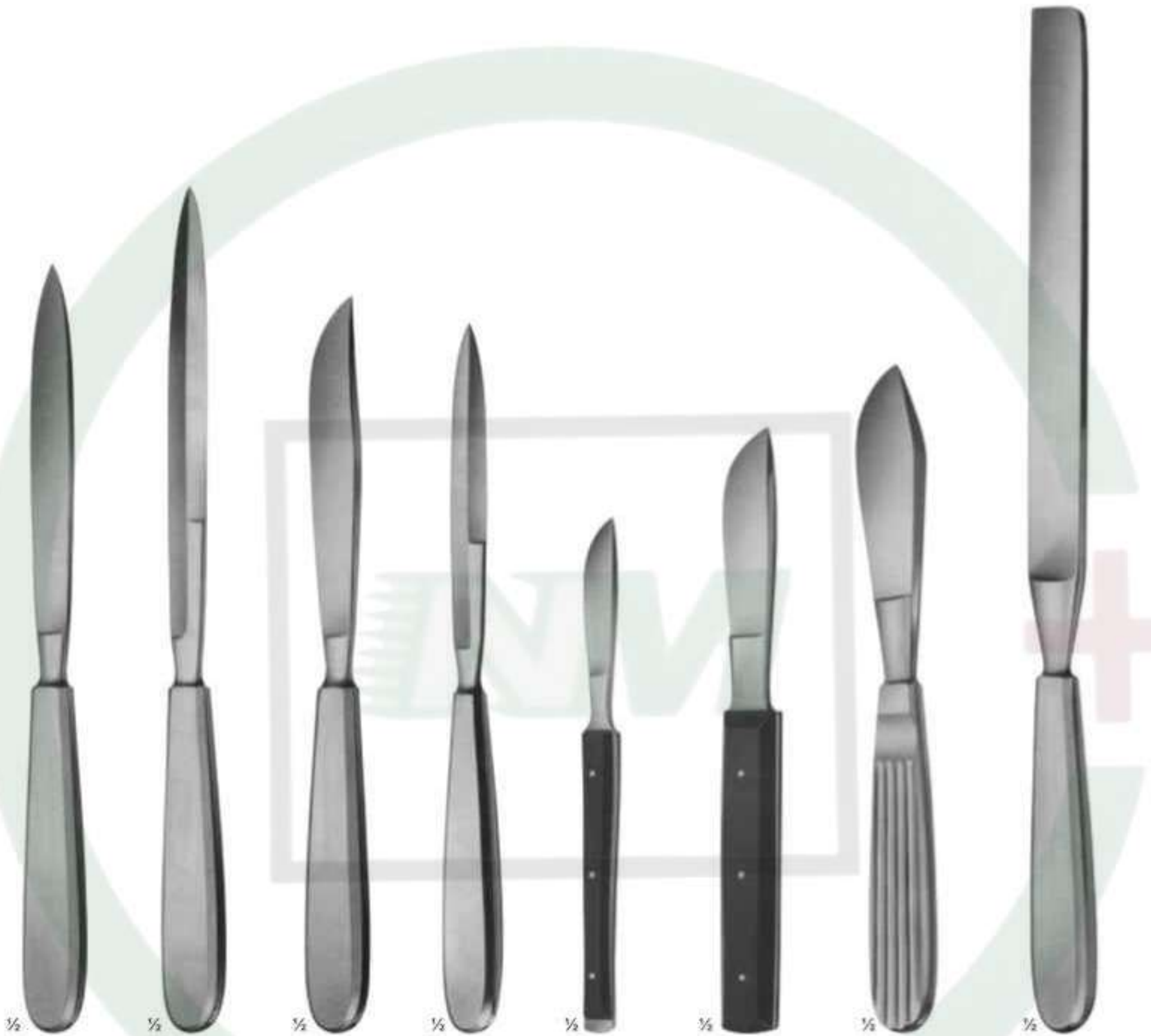

½
 LISTON
 02-111
 Size: 130 mm
 02-112
 Size: 160 mm
 02-113
 Size: 190 mm
 02-114
 Size: 200 mm

½
 02-115
 CATLIN
 Size: 160 mm
 Blade length
 Amputating
 Knives

½
 02-116
 LANGENBECK
 Size: 120 mm
 Blade length
 Flap Knives

½
 02-117
 Size: 110 mm
 Blade length
 Interosseous
 Knives

½
 02-118
 Size: 55 mm
 Blade length
 with raspatory,
 Wooden handle

½
 02-119
 Size: 70 mm
 Blade length
 Wooden handle

½
 02-120
 Size: 80 mm
 Blade length
 Metal handle

½
 02-121
 Size: 195 mm
 Blade length
 Metal handle

Blade length
Amputating Knives:



Cone Knives, Myomatome, Trigemina and Tonsil Knives

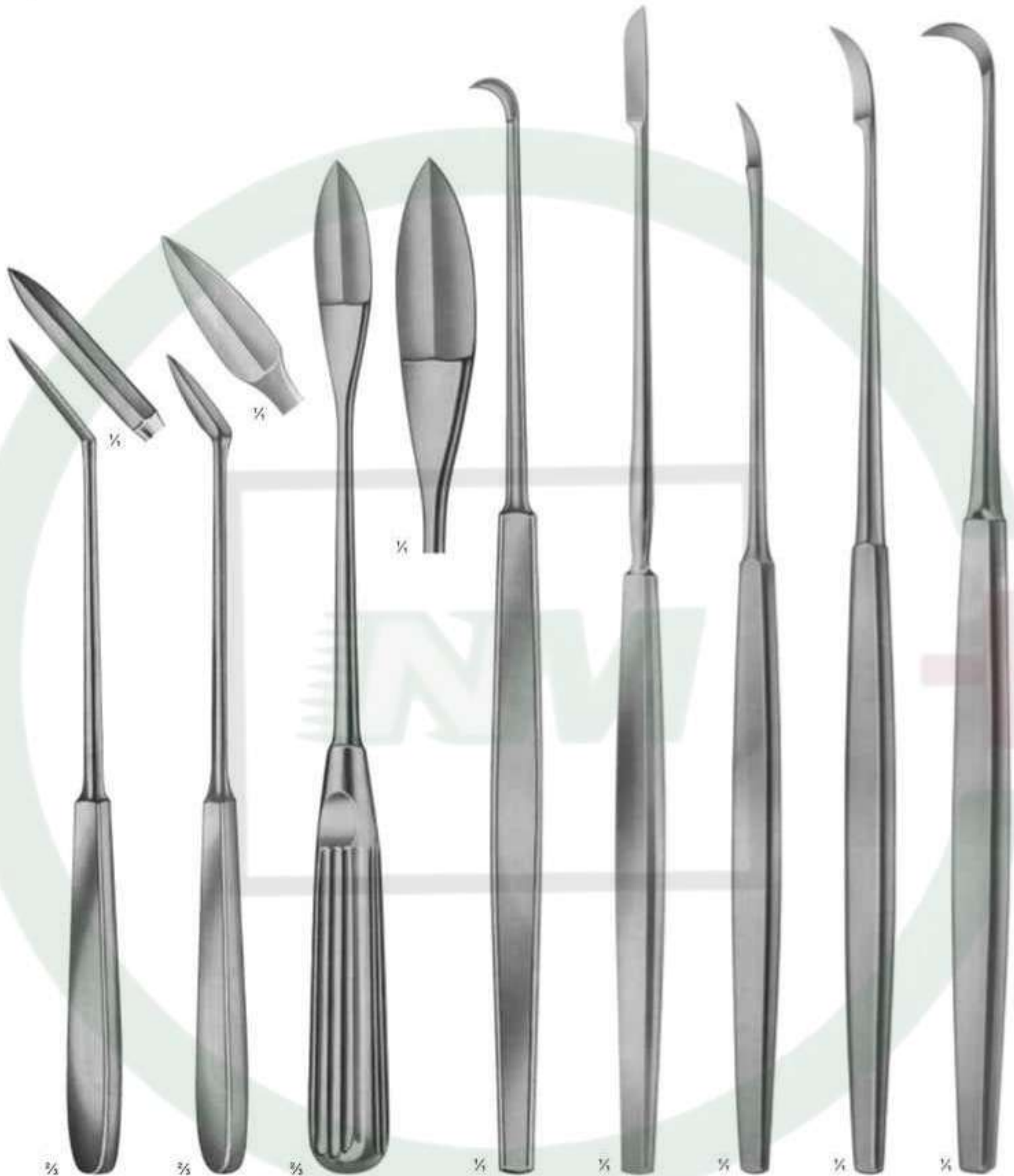

1/2

02-122
AYRE
Size: 235 mm
Cone Knife

1/2

02-123
Size: 230 mm
Cone Knife

1/2

02-124
SEGOND
Size: 270 mm
Myomatome

1/2

02-125
OLIVECRONA
Size: 205 mm
Trigeminal
Knife

1/2

02-126
Size: 230 mm
Trigeminal
Knife

1/2

02-127
FOWLER
Size: 200 mm
Tonsil Knife

1/2

02-128
ABRAHAM
Size: 215 mm
Tonsil Knife

1/2

02-129
BRUNINGS
Size: 215 mm
Tonsil Knife



Scalpel Handles

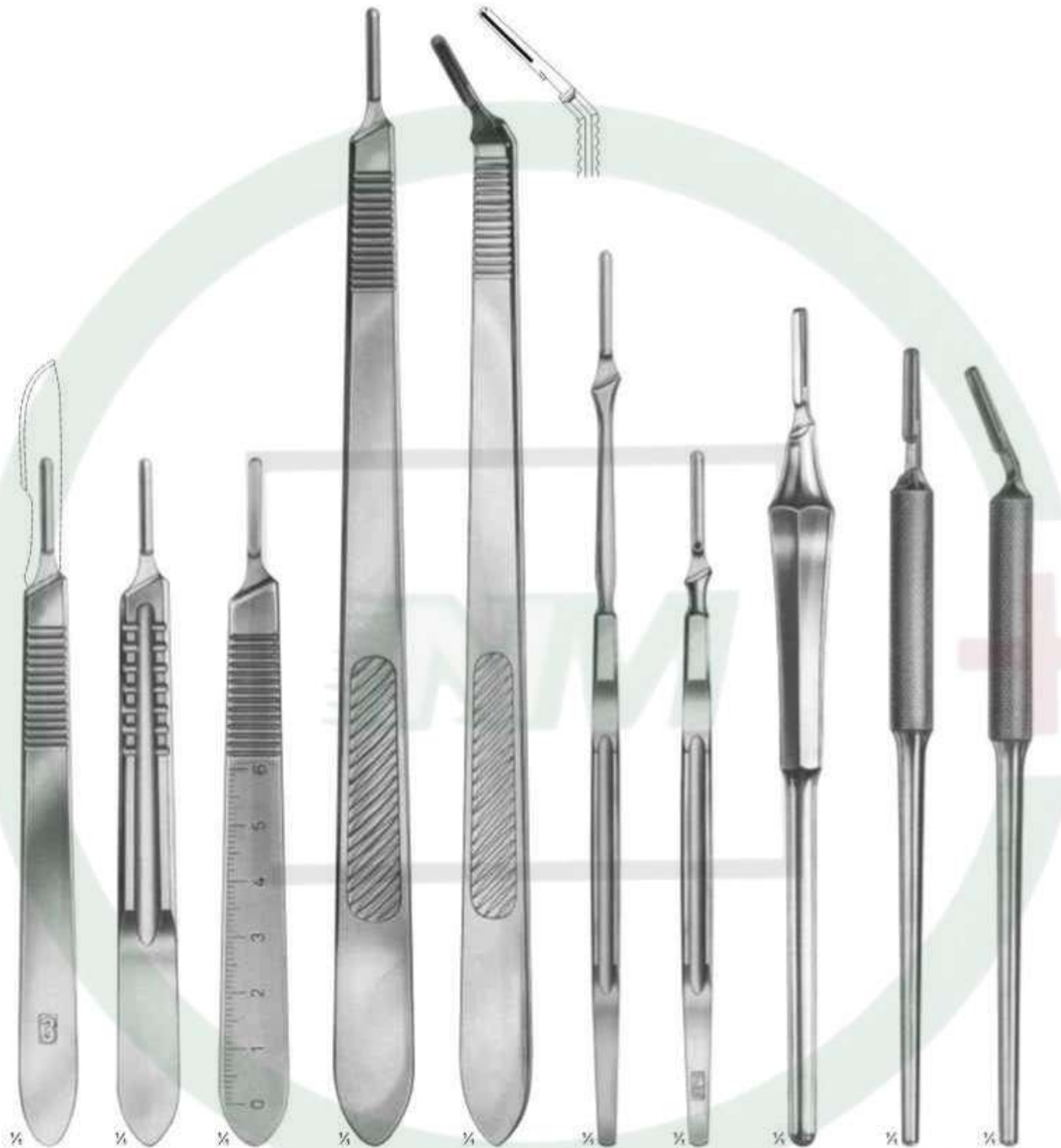

02-130
STANDARD
No. 3
Solid
12 cm

02-131
No. 3
Solid
12 cm

02-132
No. 3
Solid
12 cm

02-133
No. 3 L
Straight
Solid
21.5 cm

02-134
No. 3 L
Angled
Solid
21 cm

02-135
No. 7
Solid
16 cm

02-136
No. 7 K
Solid
12.5 cm

02-137
Hollow-Round
15.5 cm

02-138
No. 3
Straight
Solid,
Round
14.5 cm

02-139
No. 3
Angled
Solid,
Round
14 cm



Micro Scissors (Spring Type) with Flat handles

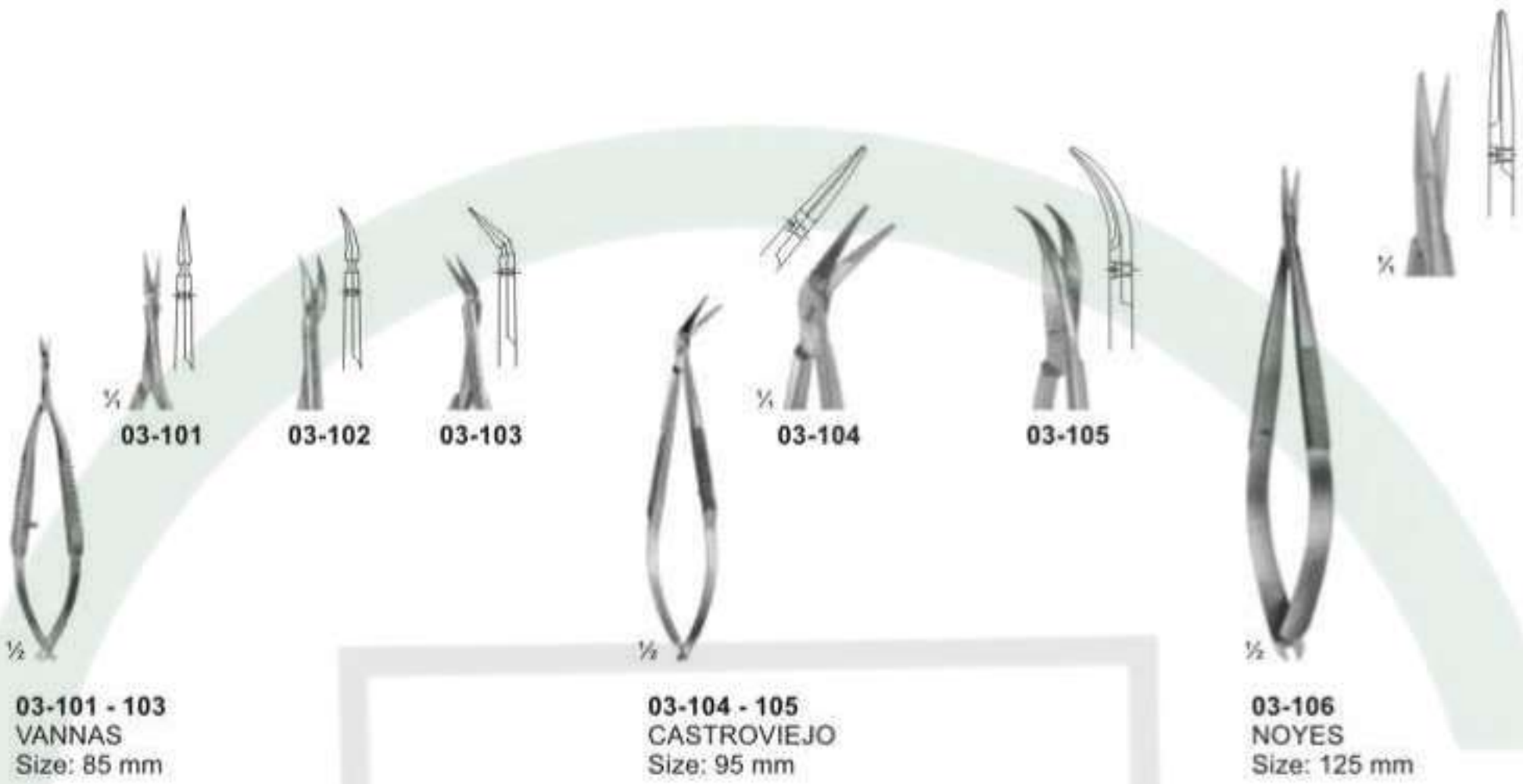

03-101 - 103
VANNAS
Size: 85 mm

03-104 - 105
CASTROVIEJO
Size: 95 mm

03-106
NOYES
Size: 125 mm

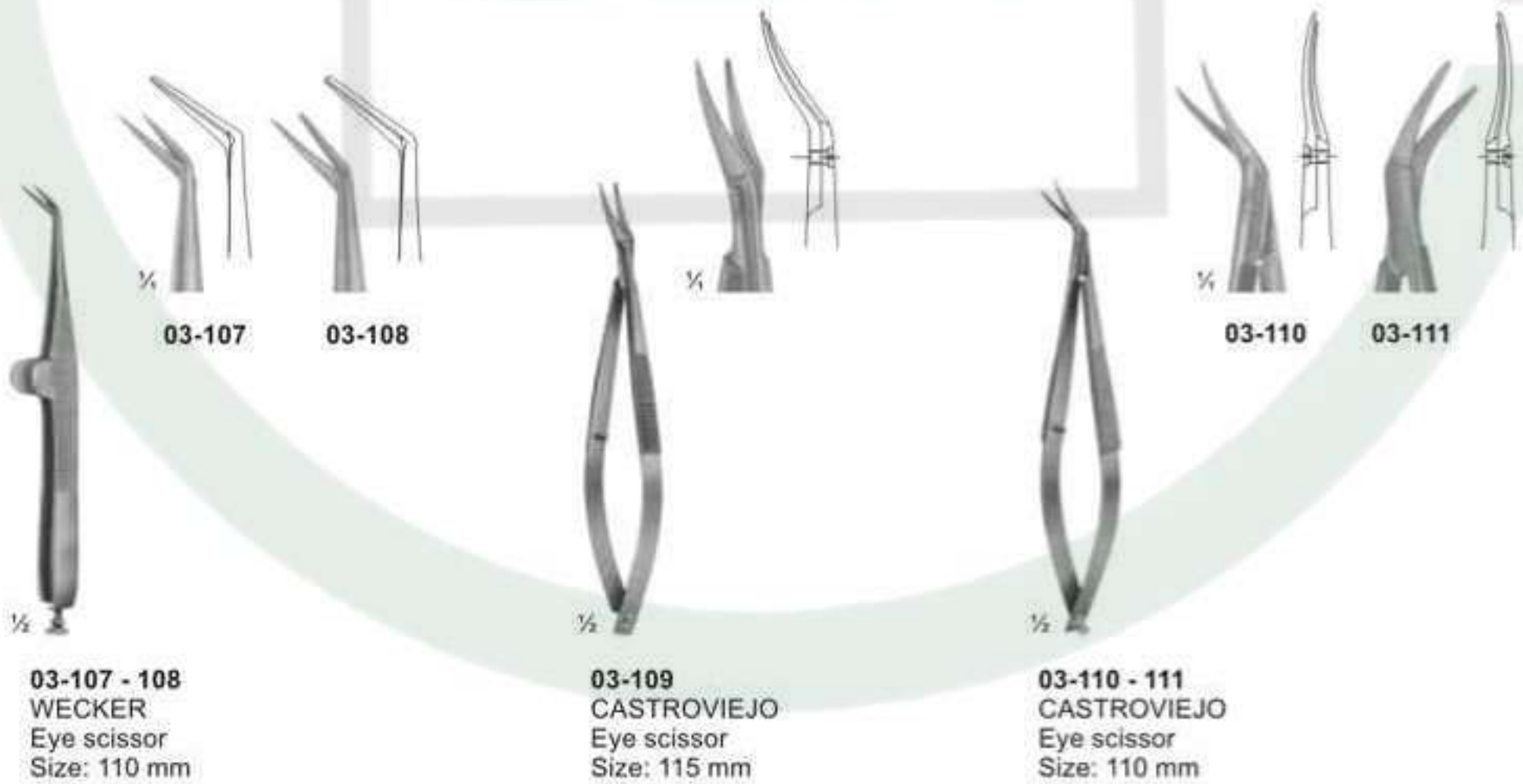

03-107 - 108
WECKER
Eye scissor
Size: 110 mm

03-109
CASTROVIEJO
Eye scissor
Size: 115 mm

03-110 - 111
CASTROVIEJO
Eye scissor
Size: 110 mm



Micro Scissors (Spring Type) with Flat handles

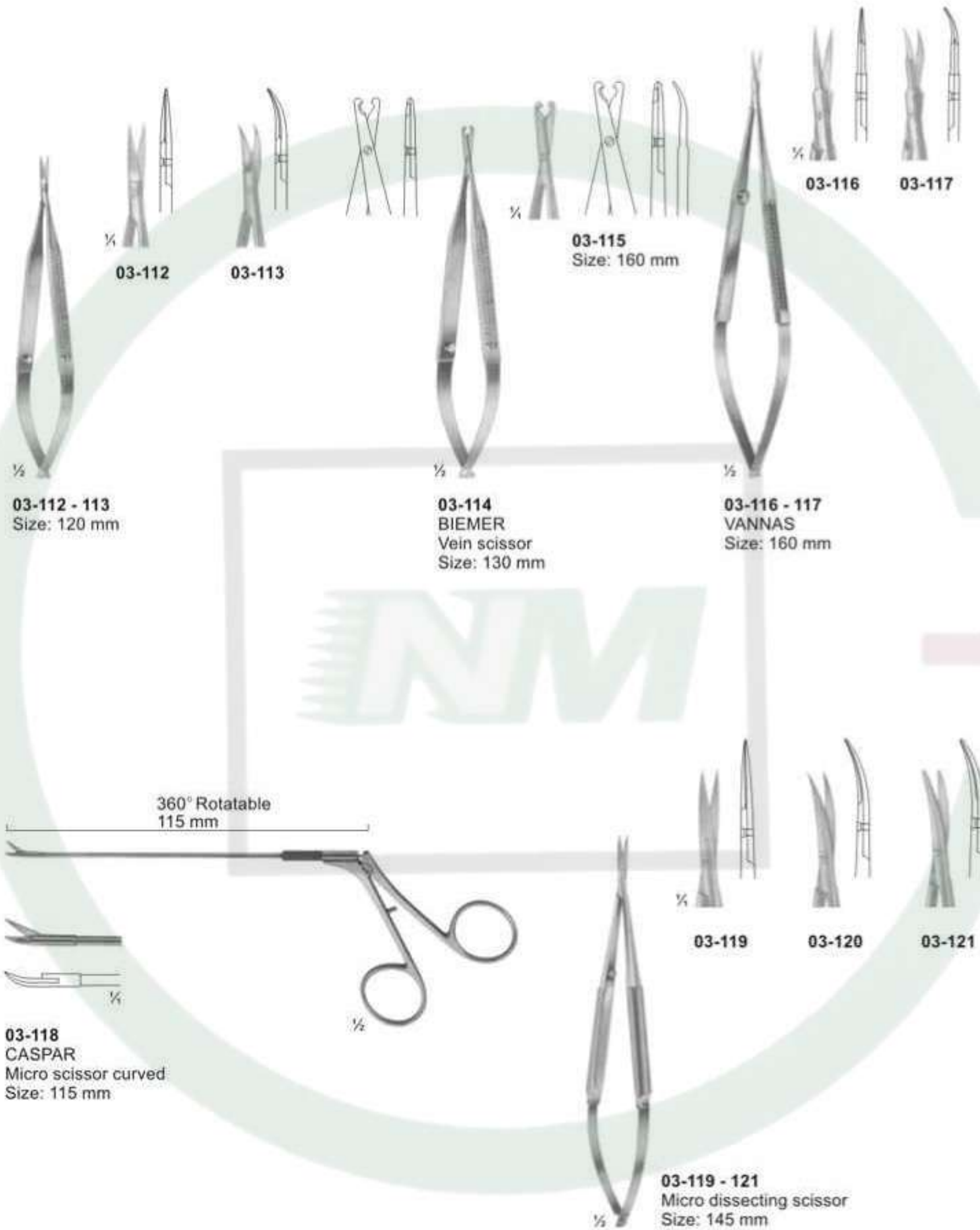



Micro Scissors (Spring Type) bayonet-зпаped



1/2
03-122
YASARGIL
Size: 245 mm

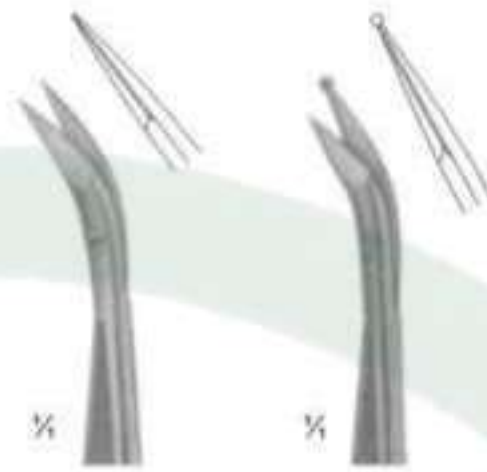

1/2
03-123
45°

1/2
03-124
45°



1/2
03-123 - 124
laterally angled
Size: 200 mm

125°



1/2
03-126

1/2
03-127



1/2
03-125
laterally angled
Size: 190 mm



1/2
03-126 - 127
YASARGIL
Size: 225 mm



Delicate Scissors

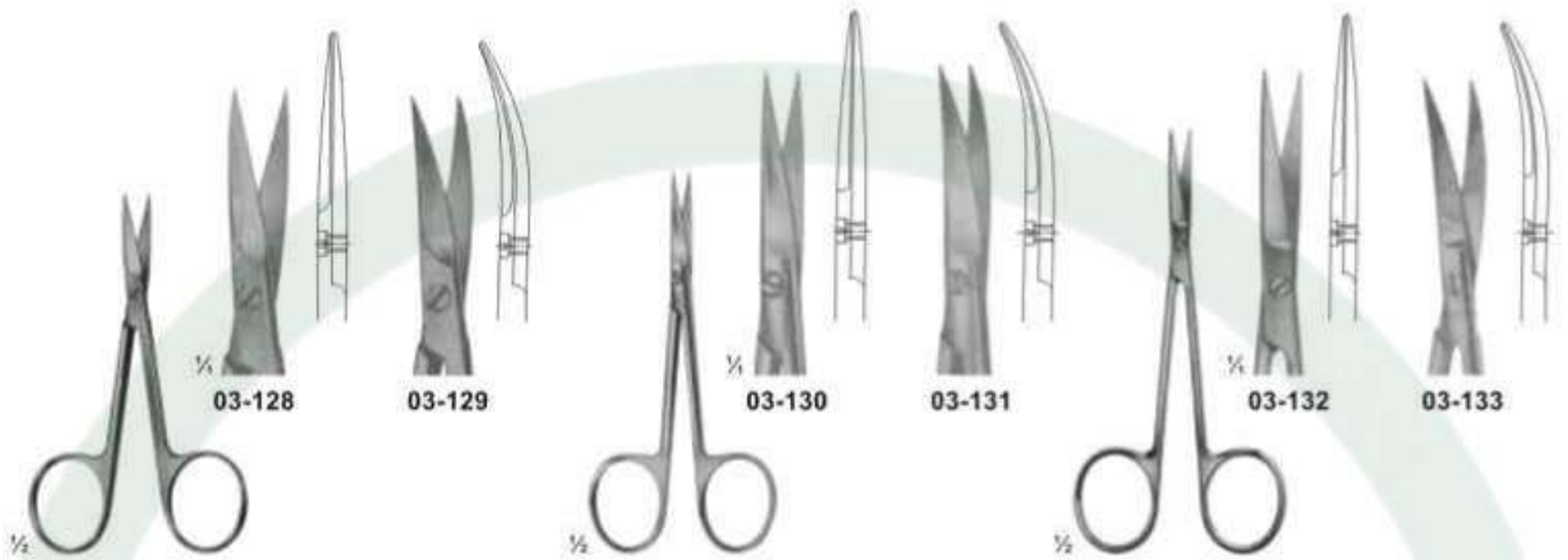

1/4
03-128

03-129

1/4
03-130

03-131

1/4
03-132

03-133

03-128 - 129
Size: 90 mm

03-130 - 131
Size: 95 mm

03-132 - 133
Size: 105 mm



1/4
03-134

03-135

1/4
03-136

03-137

03-134 - 135
Size: 120 mm

03-136 - 137
Size: 115 mm



Delicate Scissors



03-138 - 140
Size: 120 mm

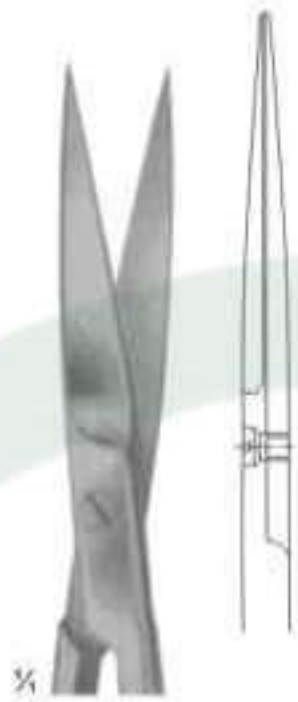

03-138

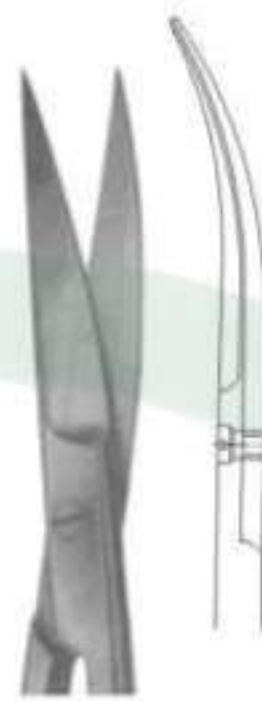

03-139



03-140



03-141 - 144
Size: 130 mm

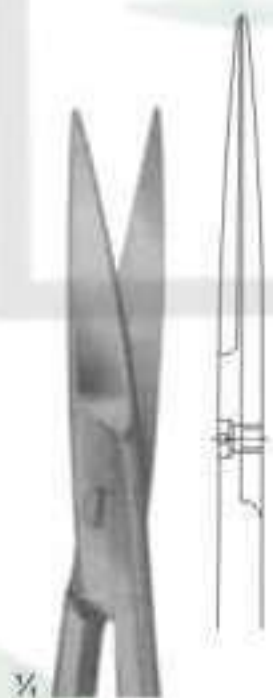

03-141

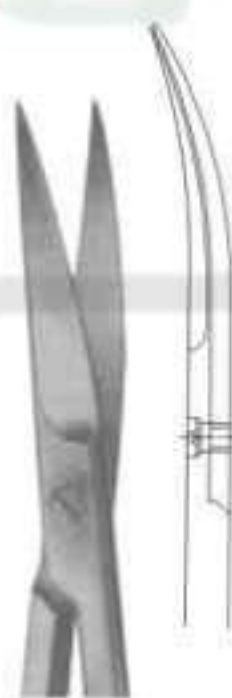

03-142



03-143



03-144



Surgical Scissors

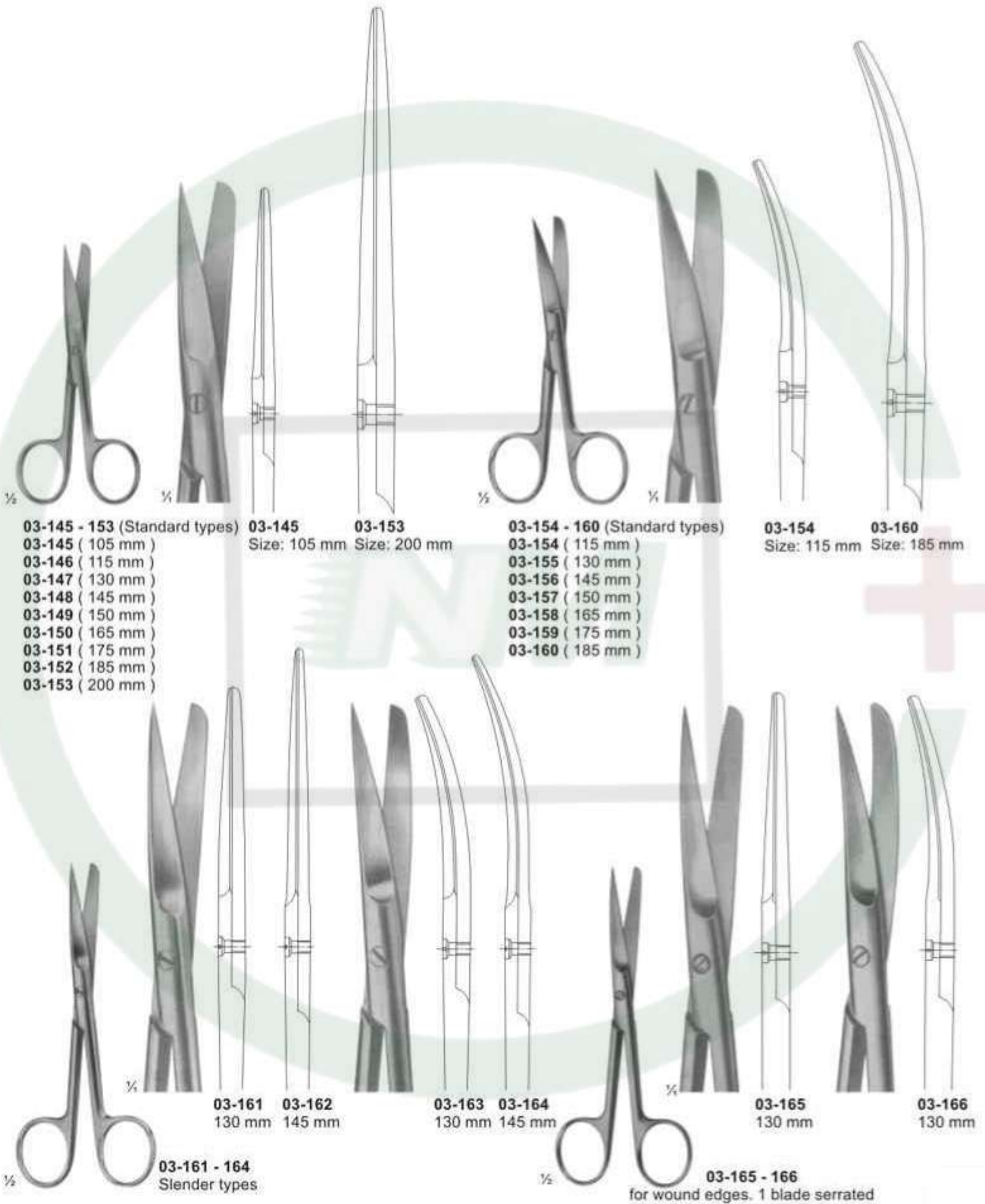



Surgical Scissors



03-167 - 169
DEAVER
with flat lock

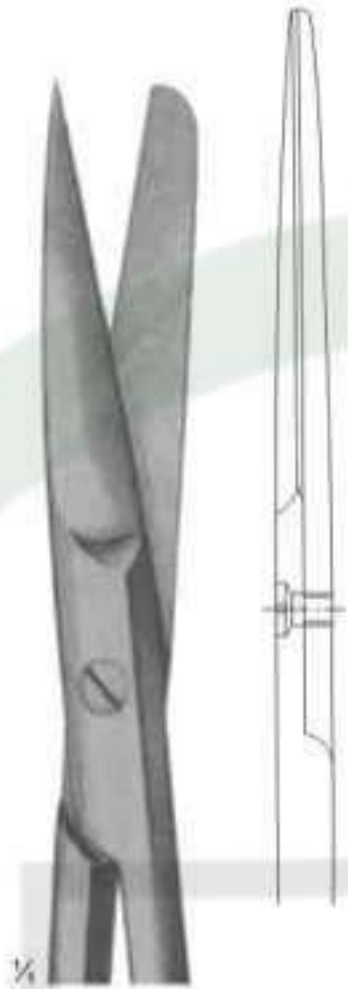

03-167
Size: 145 mm

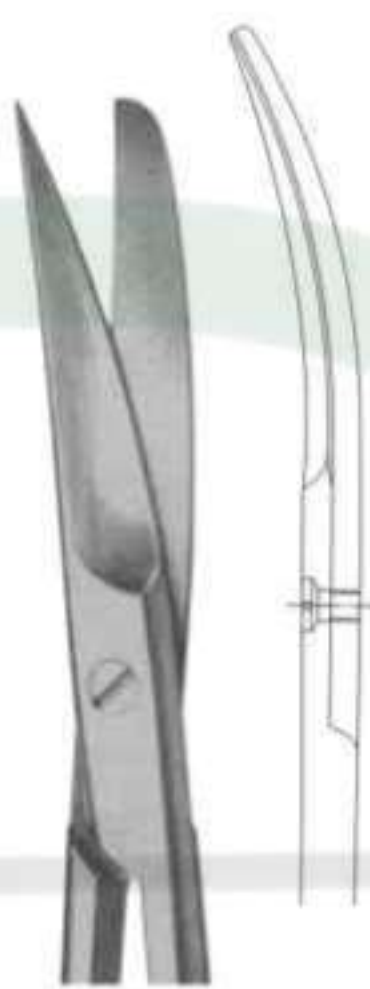

03-168
Size: 145 mm

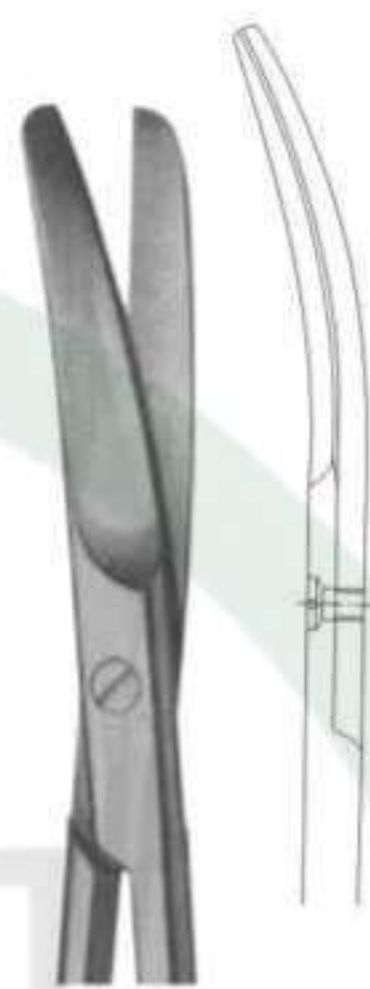

03-169
Size: 145 mm



03-170 - 172
Incision scissors



03-170
Size: 130 mm



03-171
Size: 145 mm



03-172
Size: 165 mm



03-173
SYSTRUNK
Nail splitting scissors



03-173
Size: 130 mm



Dissecting Scissors

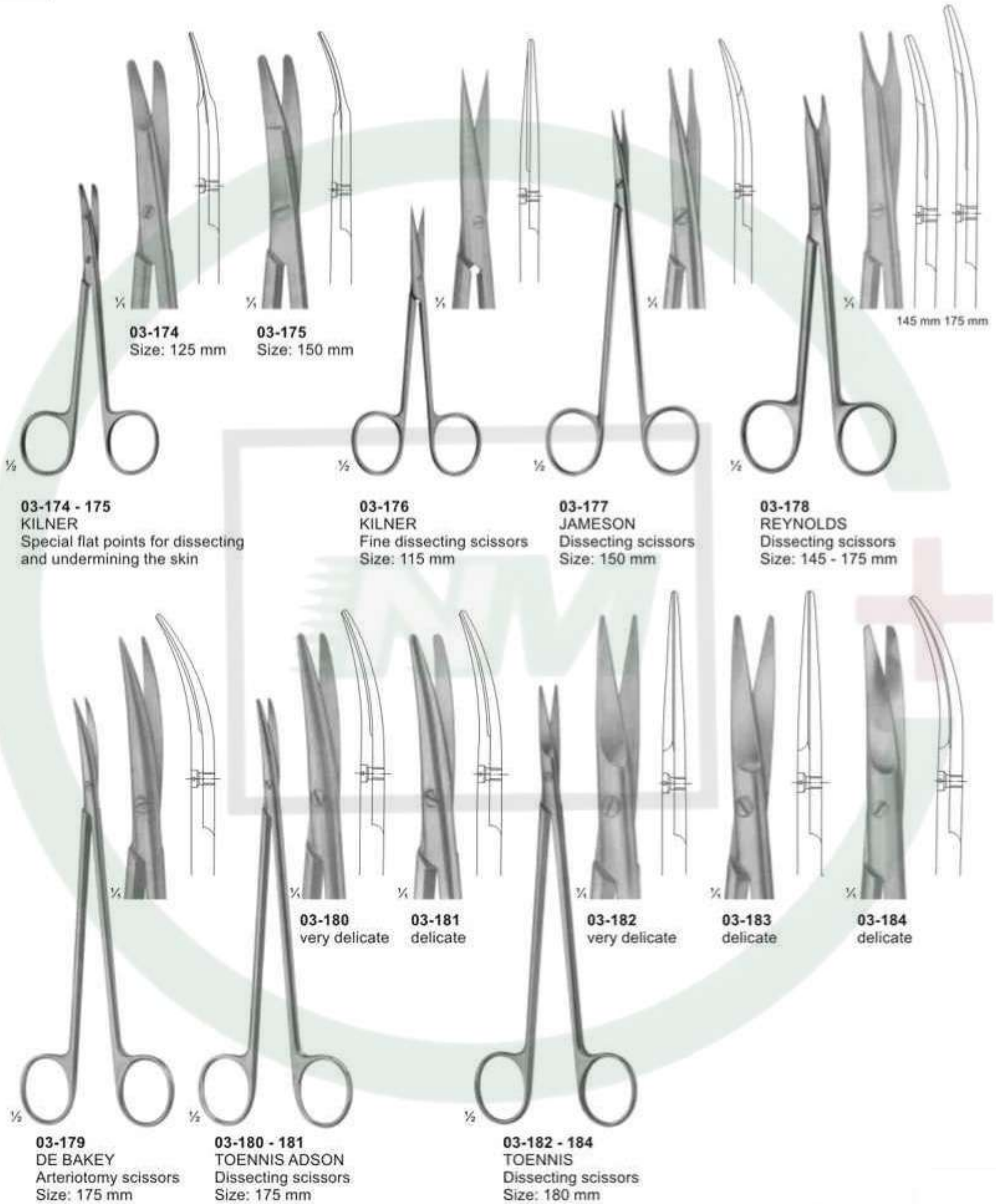



Dissecting Scissors





Scissors for Cardiovascular and Neuro-surgery

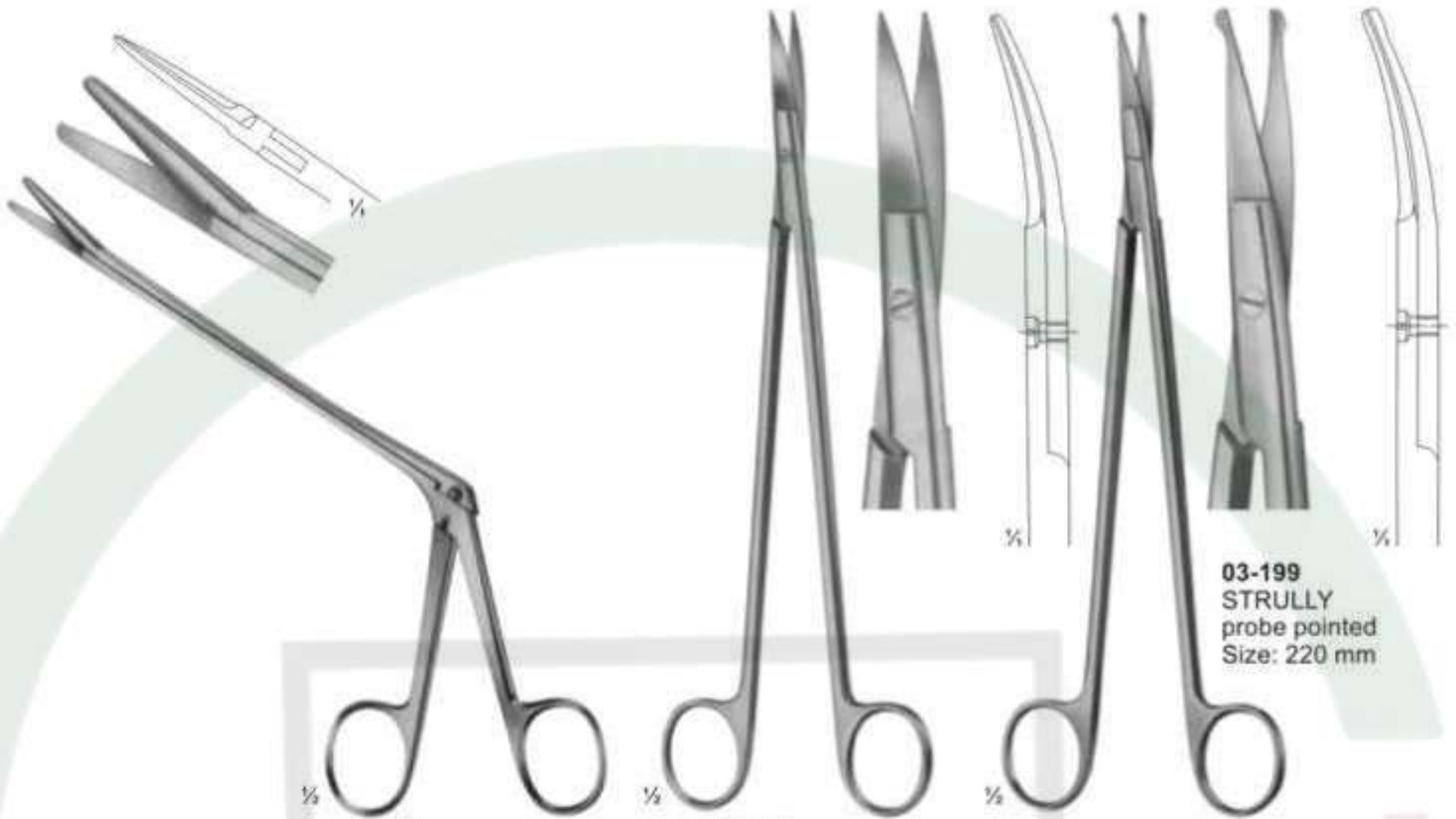

03-197
OLIVECRONA
Dura scissors

03-198
STRULLY
pointed
Size: 220 mm

03-199
STRULLY
probe pointed
Size: 220 mm



03-200
THOREK
Size: 180 mm

03-201
POTTS-SMITH
Size: 190 mm

03-202
SATINSKY
Size: 245 mm



Delicate, Nasal and Tonsil Scissors

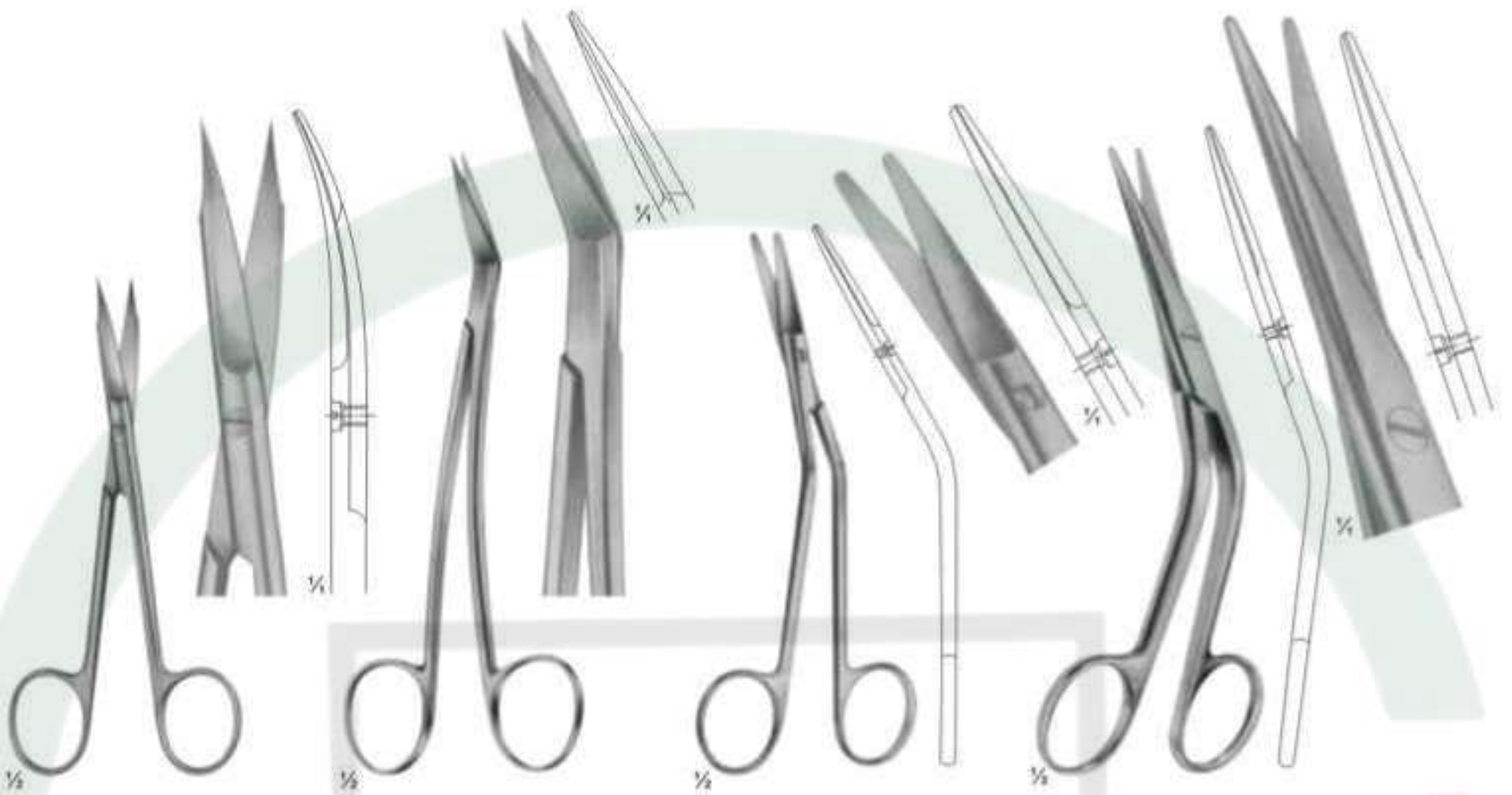

03-203
1 finely toothed blade
Size: 130 mm

03-204
LOCKLIN
curved sideways,
1 toothed blade
Size: 155 mm

03-205
FOMON
blades serrated
Size: 145 mm

03-206
COTTLE
Size: 165 mm



03-207
HEYMANN-KNIGHT
Size: 175 mm

03-208
DEAN
blades serrated
Size: 170 mm

03-209
GOOD
Size: 195 mm



Bone Shears



03-210
KILLIAN
Size: 200 mm



03-211 - 03-212



03-211
195 mm



03-212
225 mm





Scissors for deep operations and for Gynaecology

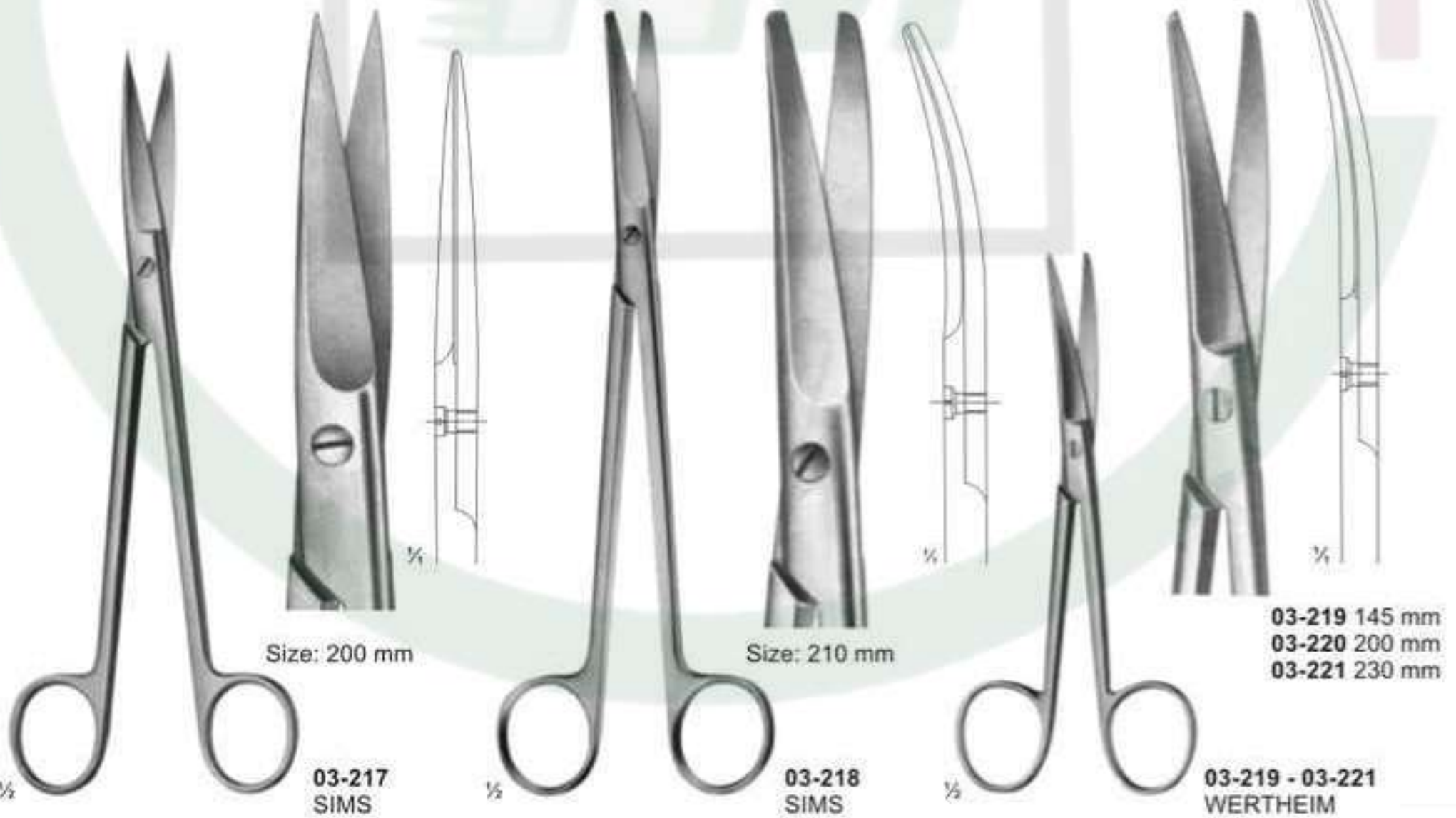
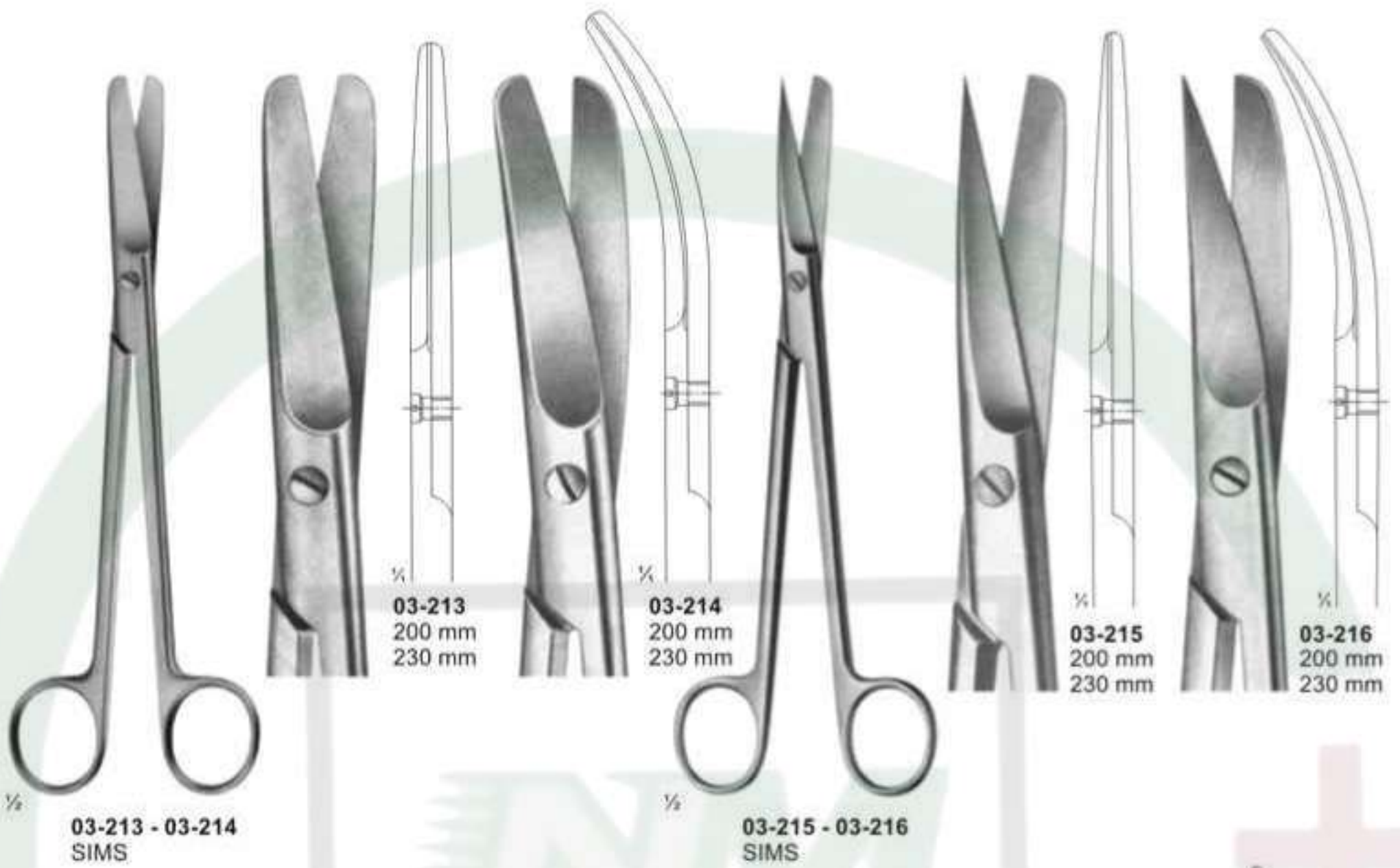



Scissors for Obstetrics



03-222
SCHUMACHER
Umbilical cord scissors
Size: 155 mm

03-223
Umbilical cord scissors
Size: 105 mm

03-224
Umbilical cord scissors

135 mm



03-225
145 mm

03-226
200 mm

03-227
Episiotomy scissors
240 mm

03-225 - 03-226
BRAUN-STADLER
Episiotomy scissors



Wire and Plate Scissors

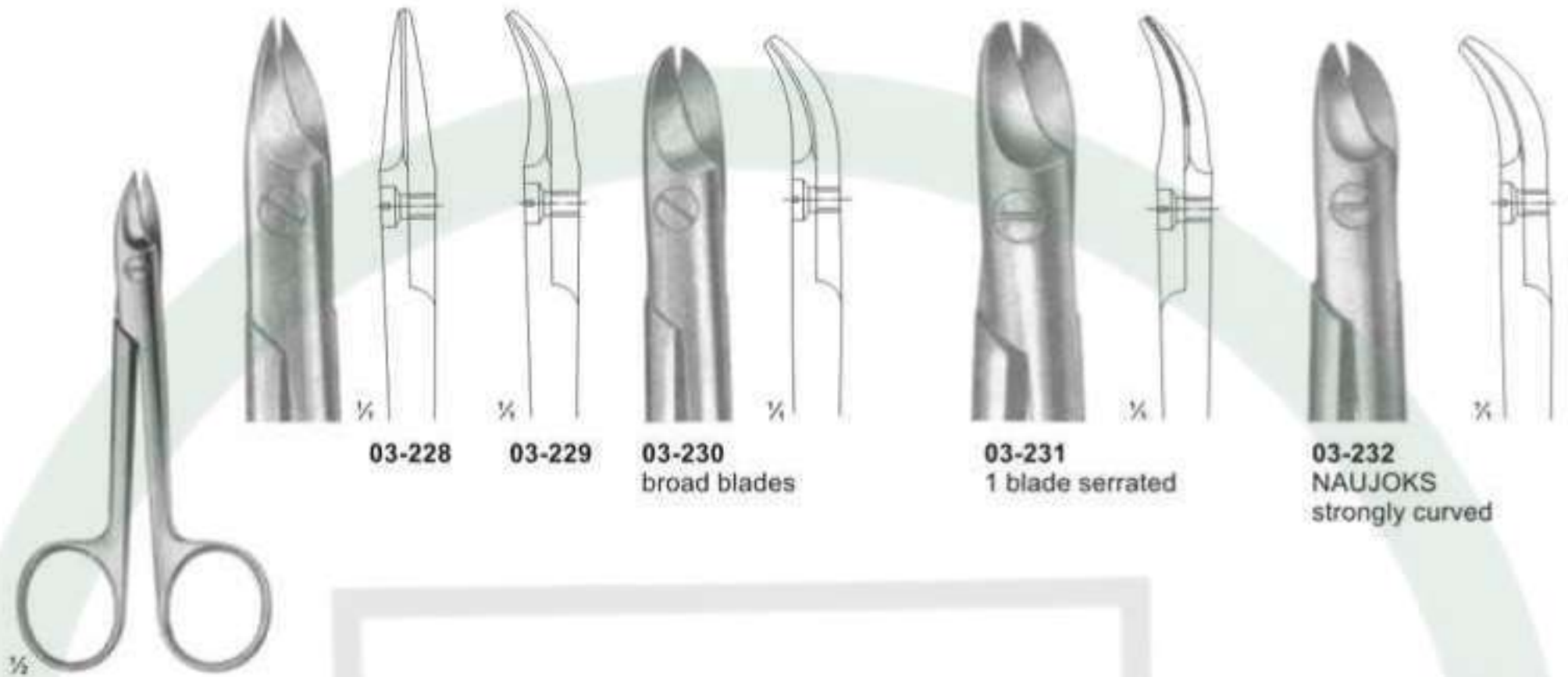

03-228

03-229

03-230
broad blades

03-231
1 blade serrated

03-232
NAUJOKS
strongly curved

03-228 - 03-232
BEEBE
Size: 110 mm

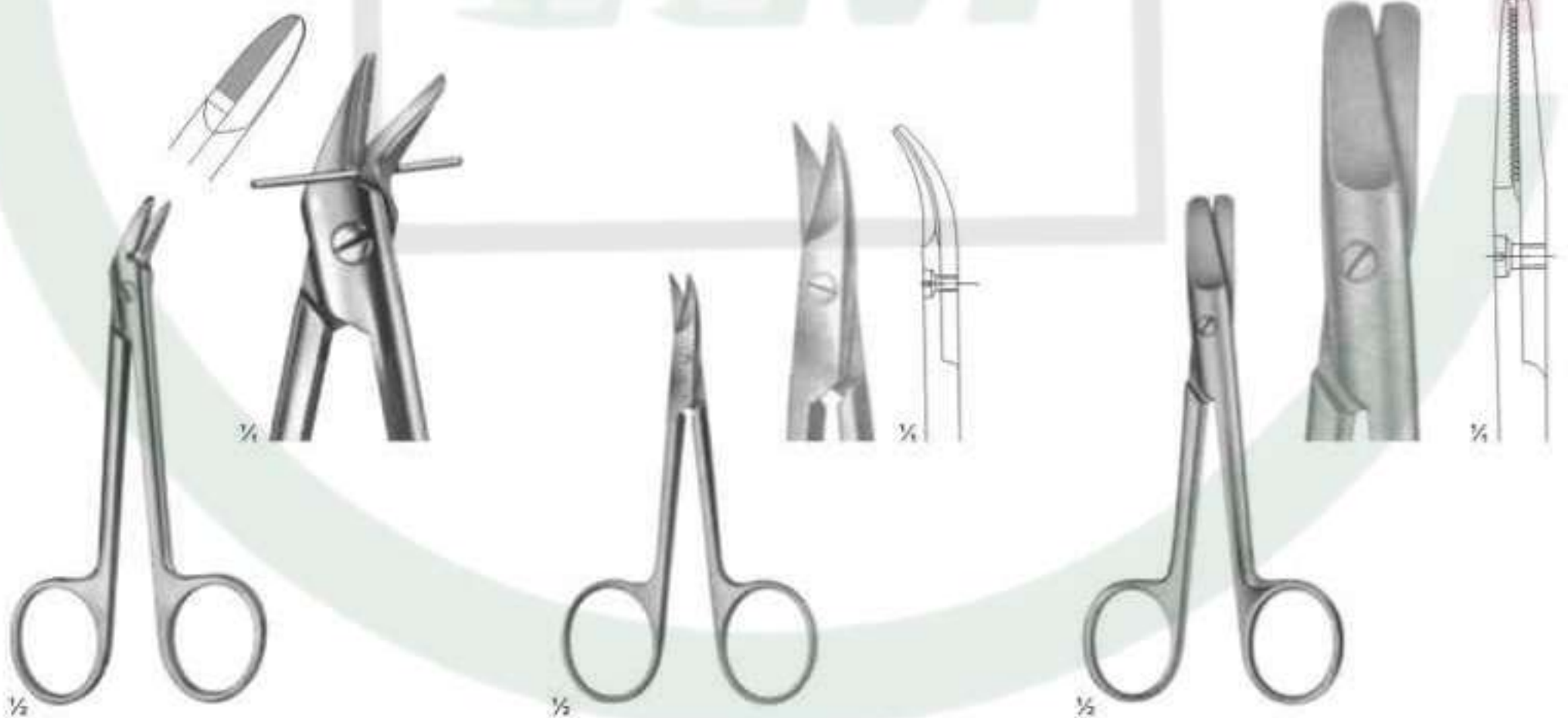

03-233
1 blade serrated
Size: 120 mm

03-234
STRACK
Size: 100 mm

03-235
HARVEY
blades serrated
Size: 125 mm



Bandage and Cloth Scissors



1/2

03-236
Universal bandage and cloth scissors,
with toothed edges
180 mm

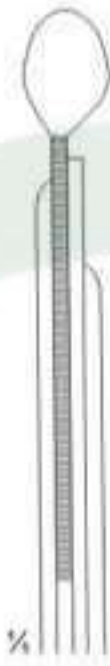

1/4



1/2

03-237
LISTER
Universal bandage and cloth scissors,
with toothed edges
Size: 145 mm



1/4

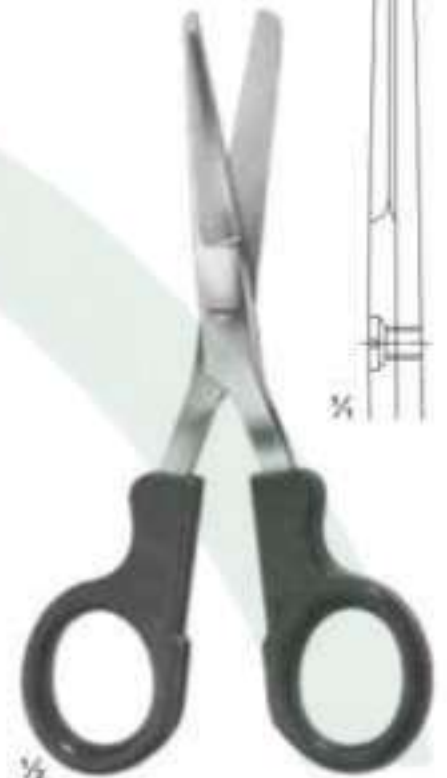

1/2

03-238
LISTER
Nurse's scissors
Size: 145 mm



1/4



1/2

03-239 - 03-242
LISTER

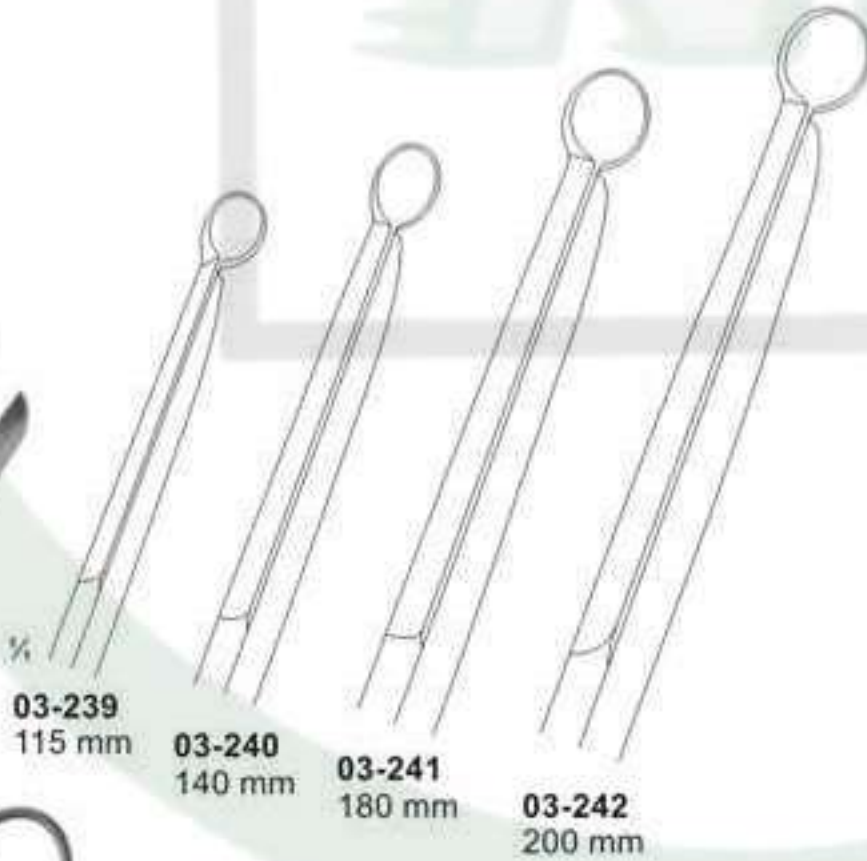

03-239
115 mm

03-240
140 mm

03-241
180 mm

03-242
200 mm



1/2

03-243 - 03-244
LISTER

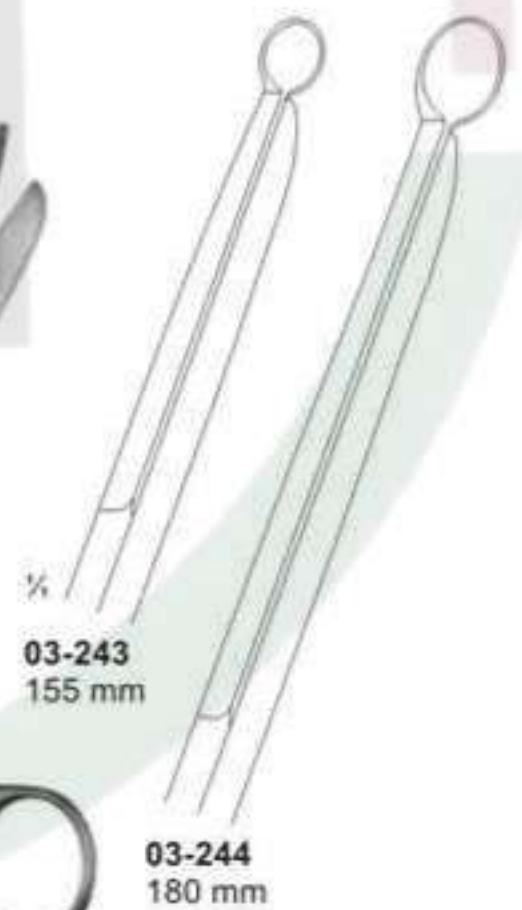

03-243
155 mm

03-244
180 mm



Bandage-, Cloth-, and Plaster Scissors



03-245
CLOTH SCISSORS
205 mm

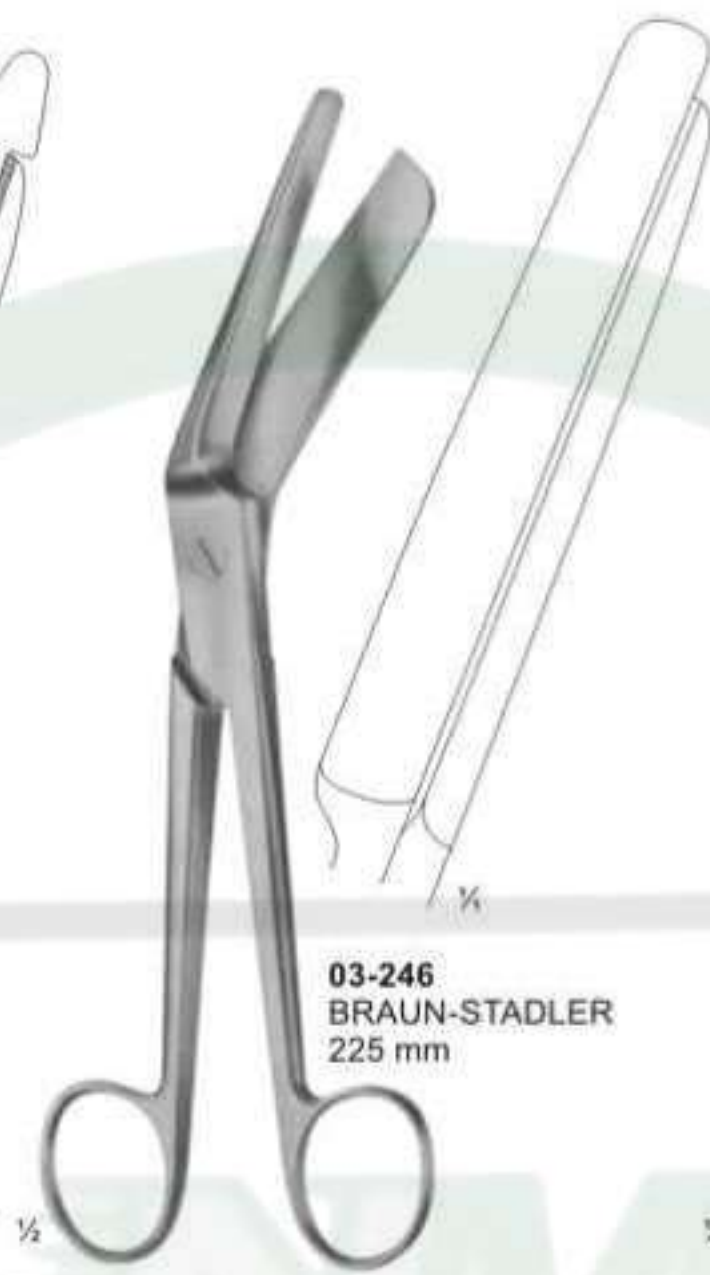

03-246
BRAUN-STADLER
225 mm



03-247
SEUTIN
230 mm



03-248 **03-249**
200 mm 230 mm

03-248 - 03-249
ESMARCH



03-250
BRUNS
235 mm



03-251
Bandage Scissors
235 mm



Forceps for grasping tissue, tumors etc.

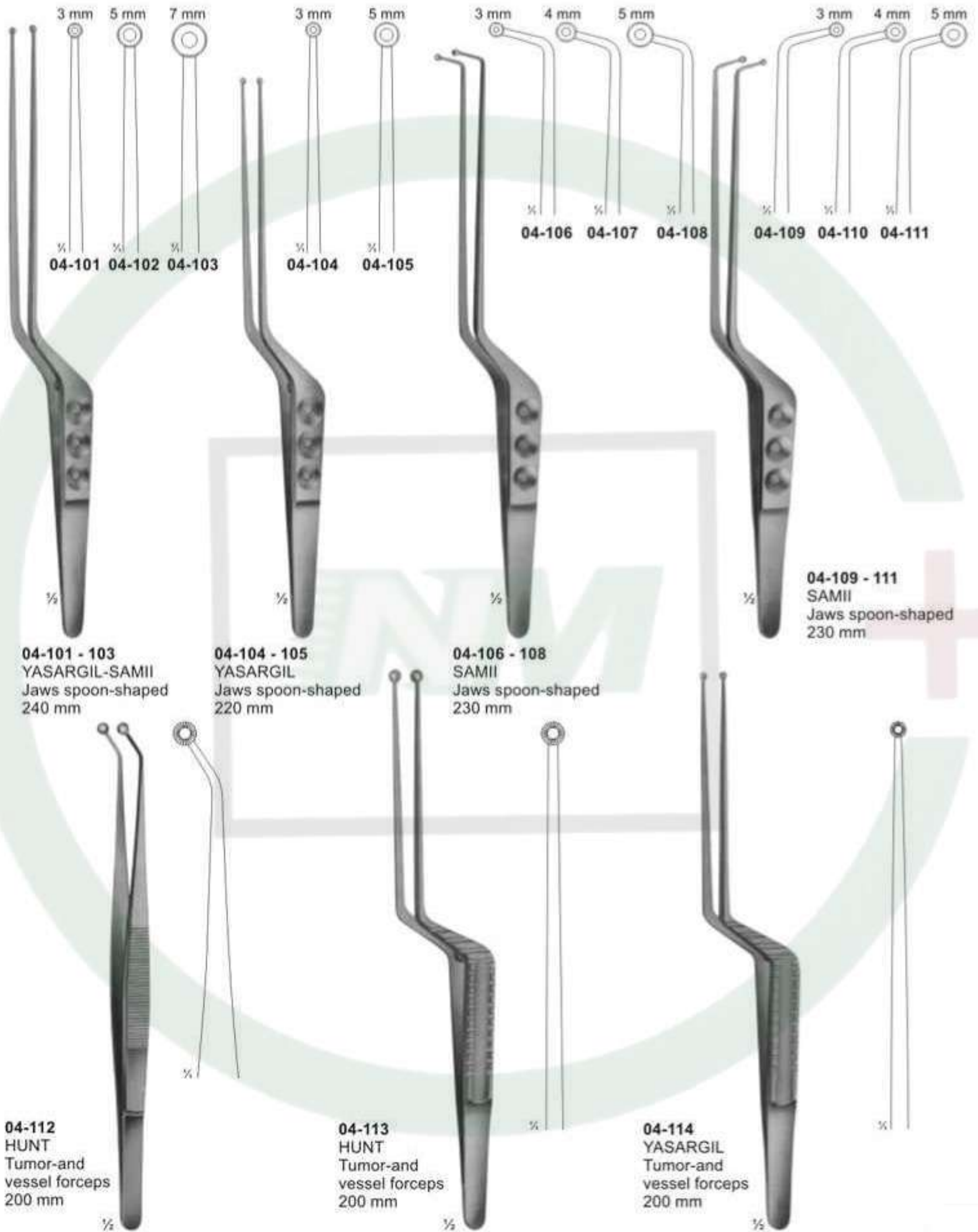



Delicate Dissecting, Microscopic, Sterilizing Forceps



04-115
THORPE
Corneal forceps
120 mm



04-116
MICRO-ADSON
120 mm



04-117
ADSON
120 mm



04-118
MICRO-ADSON
150 mm



04-119 - 121
100 mm



04-119



04-120



04-121

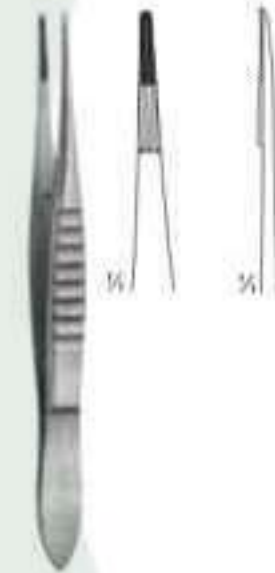

04-122
BONACCOLTO
110 mm



04-123
115 mm



04-124 - 133

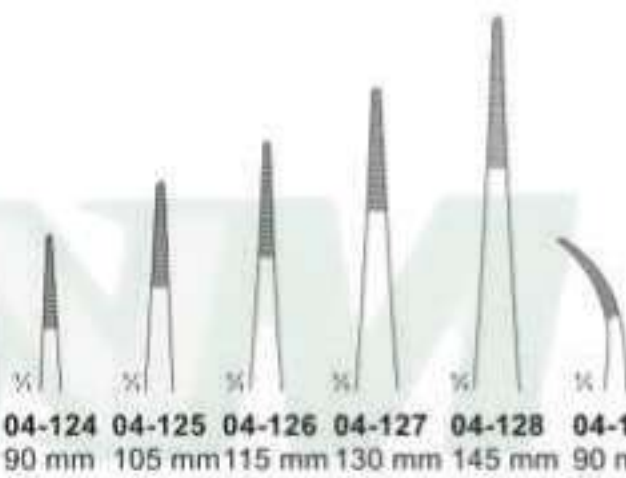

04-124 90 mm 04-125 105 mm 04-126 115 mm 04-127 130 mm 04-128 145 mm 04-129 90 mm



04-130 105 mm



04-131 115 mm



04-132 130 mm



04-133 145 mm

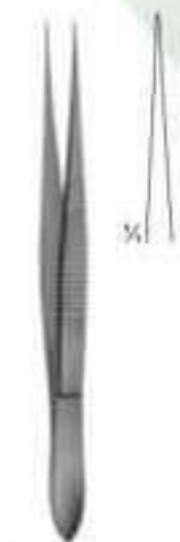

04-134
100 mm



04-135
100 mm



04-136
100 mm

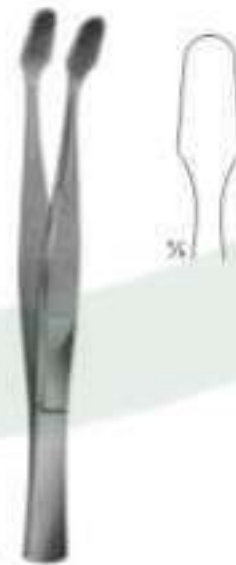

04-137
KUHNE
Cover glass forceps, 105 mm



04-138
160 mm



Delicate Dissecting Forceps

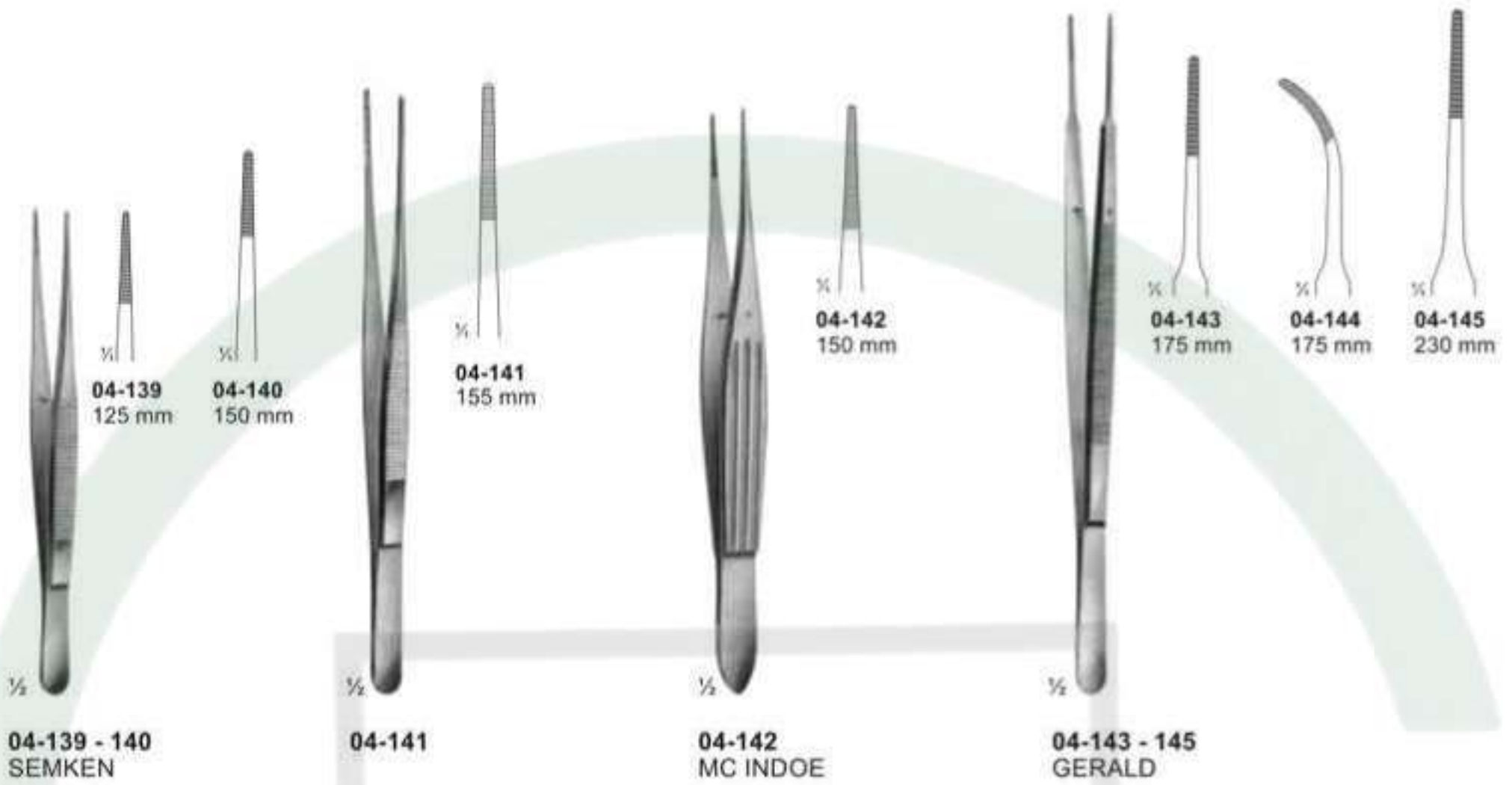



Dissecting Forceps



04-155 - 04-162
STANDARD



04-155
115 mm



04-156
130 mm



04-157
145 mm



04-158
160 mm



04-159
180 mm



04-160
200 mm



04-161
250 mm



04-162
300 mm



04-163 - 04-167
MEDIUM



04-163
115 mm



04-164
130 mm



04-165
145 mm



04-166
160 mm



04-167
305 mm



04-168 - 04-169
MEDIUM



04-168
130 mm



04-169
145 mm



Forceps

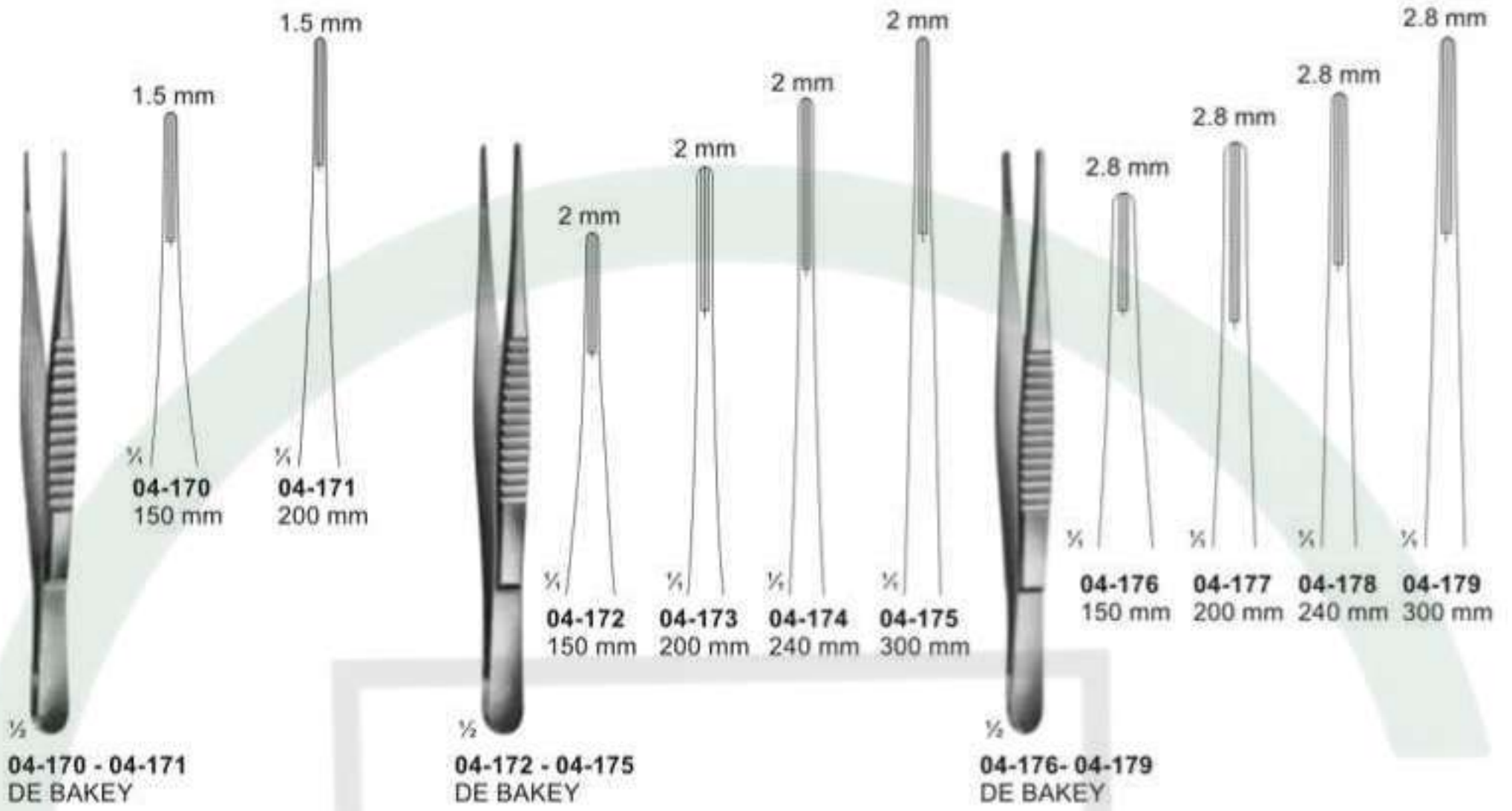



Delicate Tissue Forceps



04-185
BISHOP-HARMON
85 mm

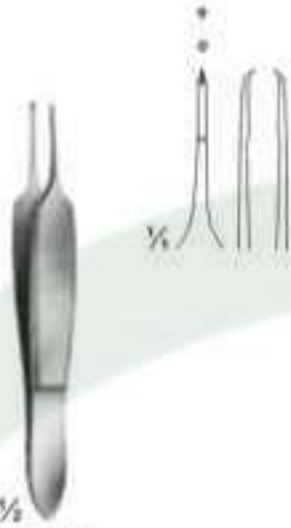

04-186
ST. MARTIN
80 mm

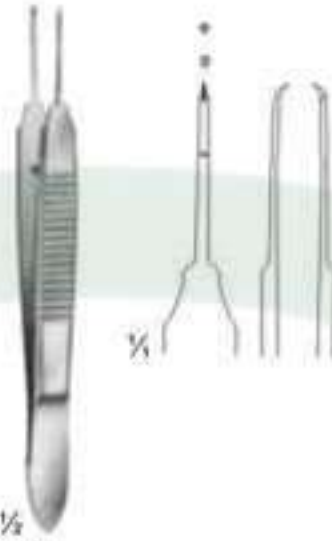

04-187
CASTROVIEJO
teeth 0.9 mm
100 mm



04-188
CASTROVIEJO
teeth 0.5 mm
100 mm

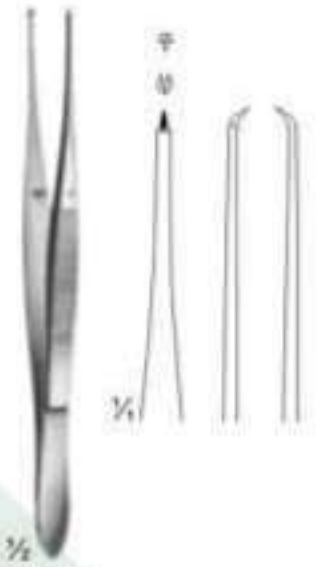

04-189
ELSCHING
110 mm



04-190
GILL
75 mm



04-191
GILL - HESS
75 mm



04-192
HESS
70 mm



04-193
ARRUGA
100 mm



04-194
SEMKEN
125 mm, 125 mm, 150 mm
2 X 3 teeth



04-195
MICRO-ADSON
120 mm



04-196
ADSON
120 mm



04-197
ADSON
120 mm



04-198
ADSON
120 mm



04-199
ADSON
150 mm



Tissue Forceps

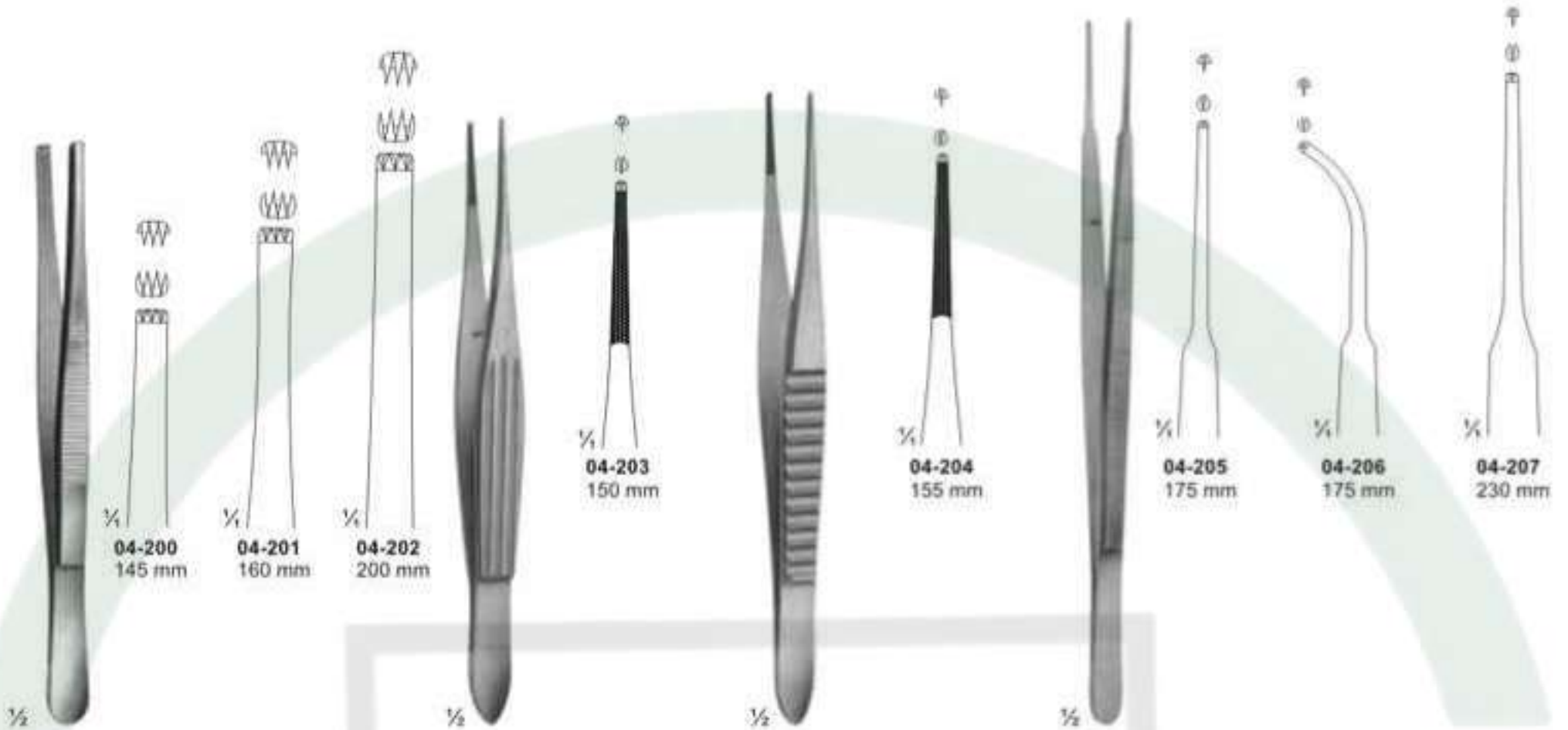

04-200 - 04-202
3x4 teeth

04-203
MC INDOE

04-204
GILLIES

04-205 - 04-207
GERALD

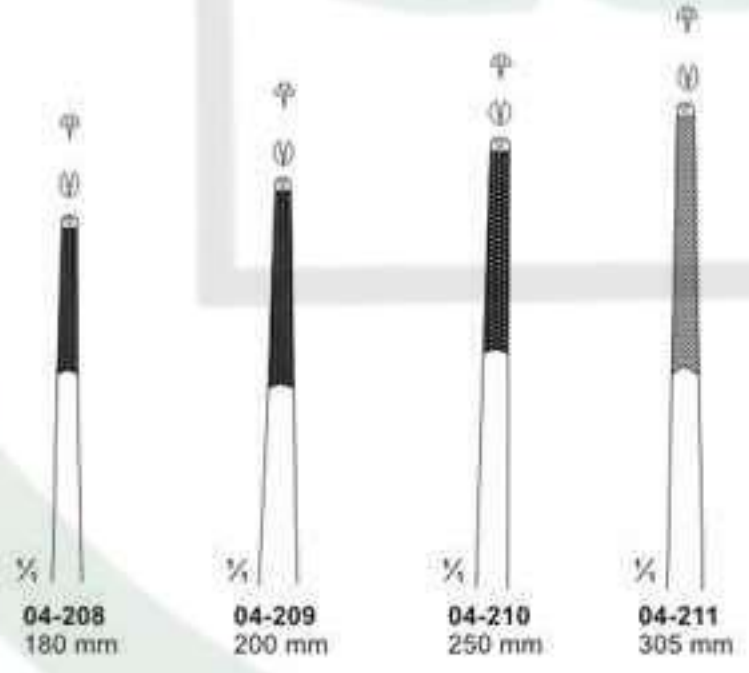

04-208 - 04-211
WAUGH



04-212
BROPHY



Tissue Forceps



**04-213
ADSON - BROWN
Non-traumatic
120 mm**



**04-214
BROWN
120 mm**



**04-215
GRAEFE
110 mm**



**04-216
GRAEFE
With Catch
110 mm**



**04-217 - 04-225
STANDARD**

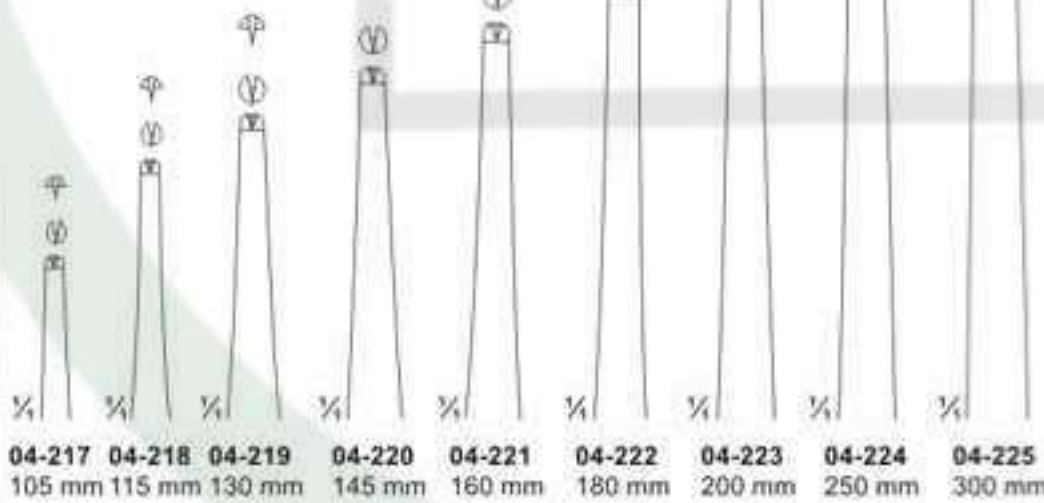

**04-226 - 04-230
GRAEFE
110 mm**

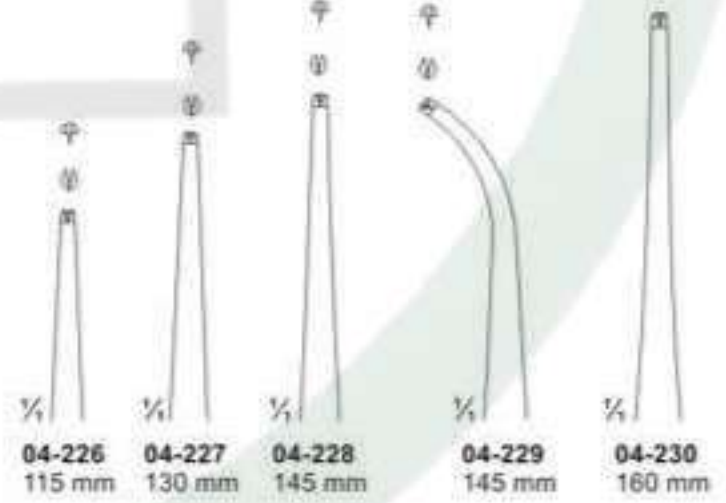



Forceps, Bayonet - Shaped



04-231
LUCAE
140 mm

04-232
LUCAE
1x2 teeth
140 mm

04-233
COTTLE
Forceps with
jaws toothed
and serrated
140 mm

04-234
JANSEN
160 mm

04-235
GRUENWALD
200 mm

04-236
1x2 teeth
200 mm

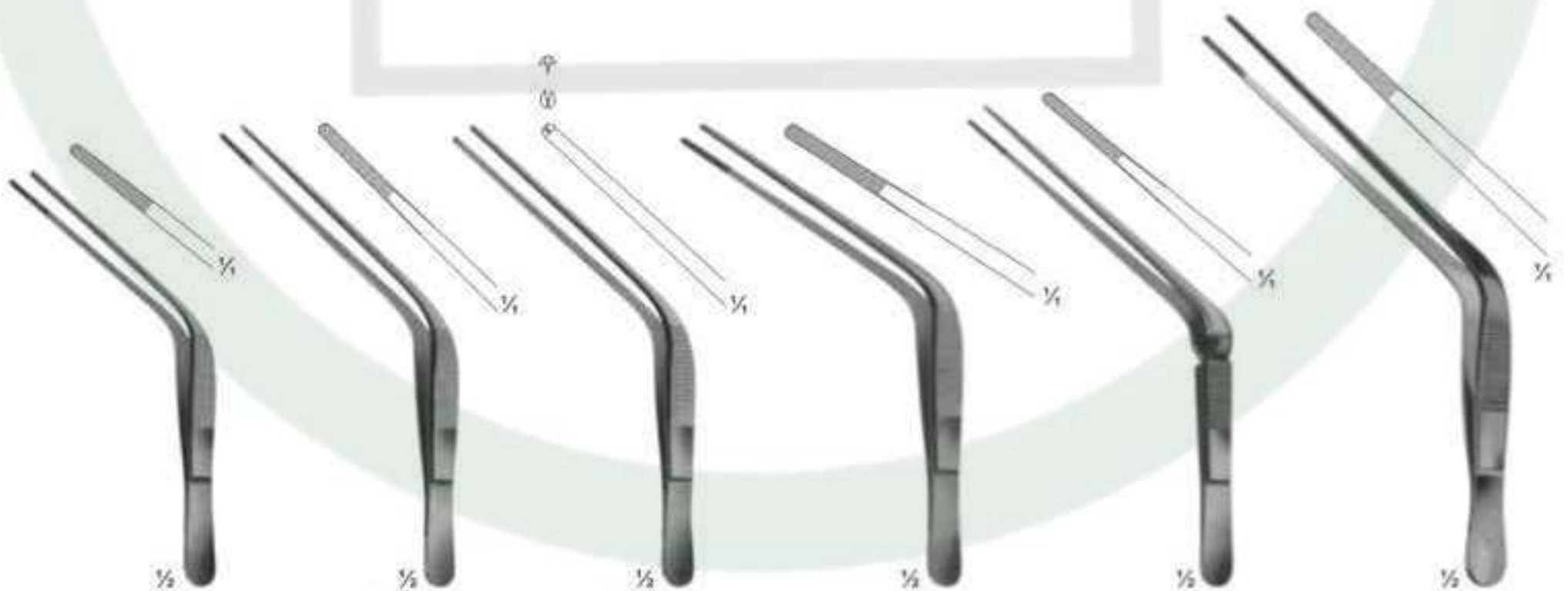

04-237
TROELTSCH
100 mm

04-238
TROELTSCH
115 mm

04-239
TROELTSCH
1X2 teeth
115 mm

04-240
WILDE
115 mm

04-241
TROELTSCH
Cross action
120 mm

04-242
TROELTSCH
140 mm



Tissue Forceps, Lung Dissecting Forceps





Splinter and Cilia Forceps

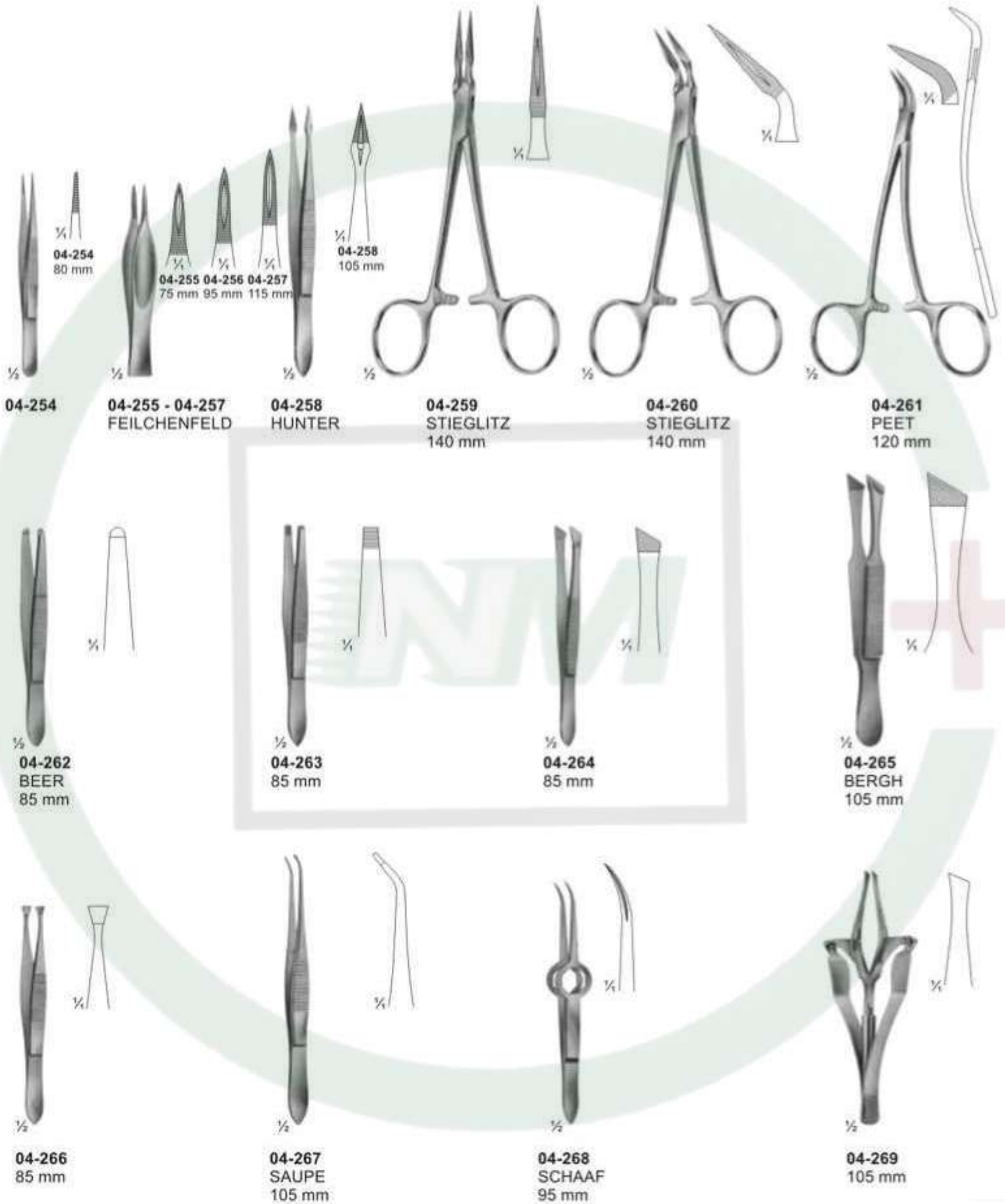



Sponge and Dressing Forceps

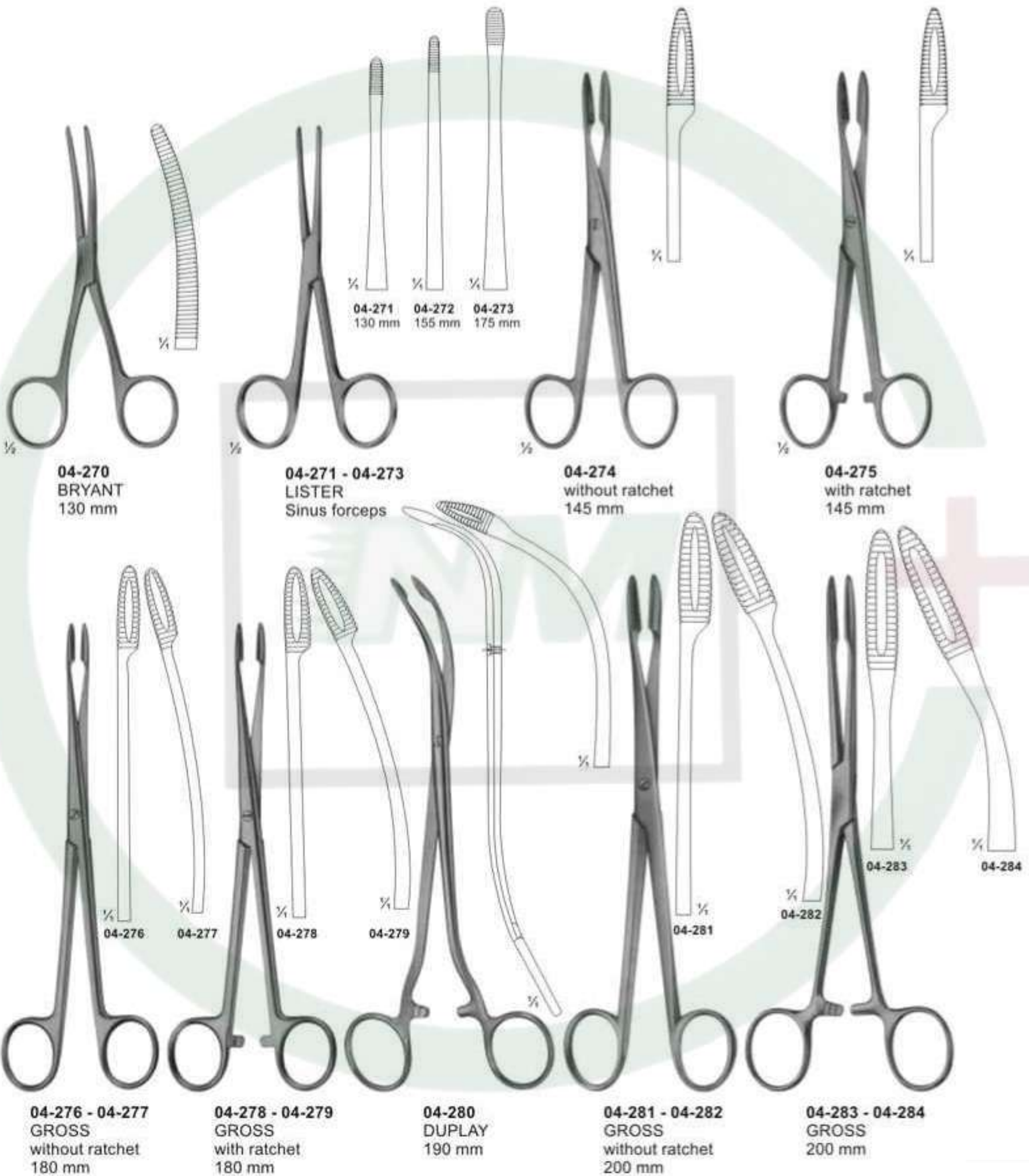



Dressing-, Sponge holding-, Organ- and Tissue Grasping Forceps

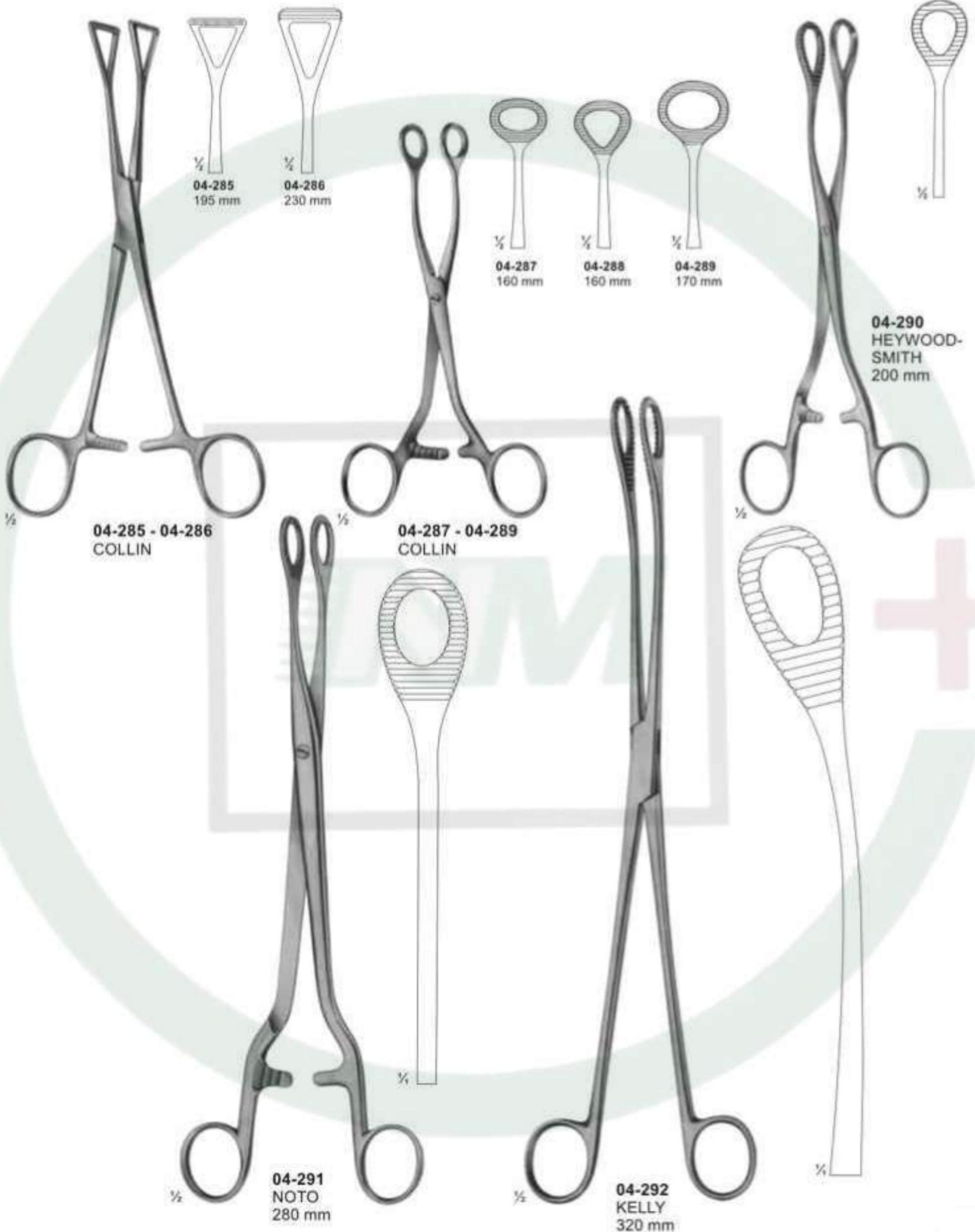



Dressing, Sponge holding, Organ and Tissue Grasping Forceps



04-293 - 04-294
FOERSTER-BALLENGER
180 mm



04-293



04-294



04-295 - 04-296
RAMPLEY



04-295
180 mm



04-296
250 mm



04-297 - 04-300
FOERSTER-BALLENGER
240 mm



04-297
Smooth Jaws



04-298
Smooth Jaws



04-299
Serrated Jaws



04-300
Serrated Jaws

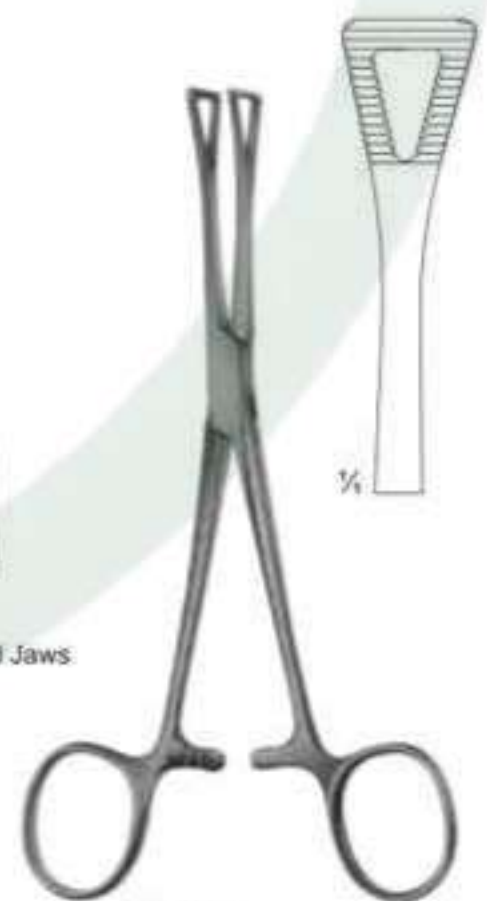

04-301
PENNINGTON
155 mm





Intestinal Grasping Forceps

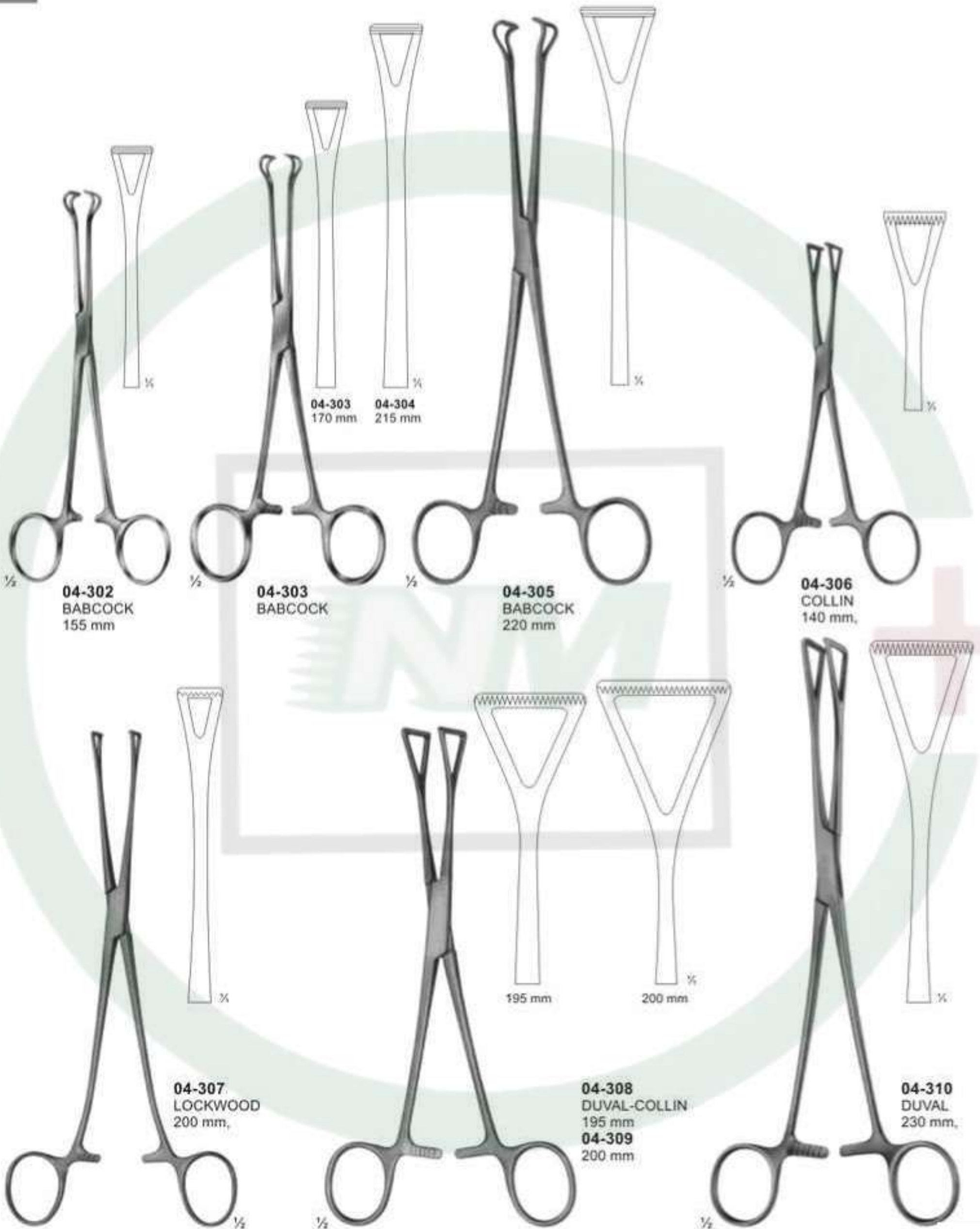



Artery Traction - and Tissue Grasping Forceps



04-311
CHAPUT
2 x 3 teeth
125 mm

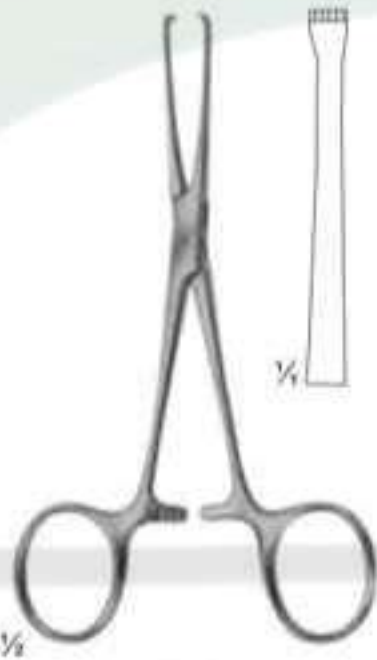

04-312
BABY-ALLIS
4 x 5 teeth
130 mm



04-313
BOYS-ALLIS
5 x 6 teeth sharp
155 mm

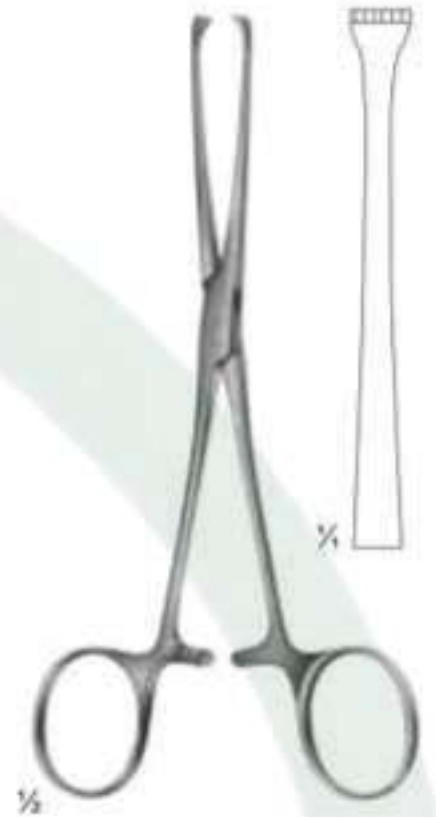

04-314
ALLIS
5 x 6 teeth
155 mm



04-315
LAHEY
155 mm

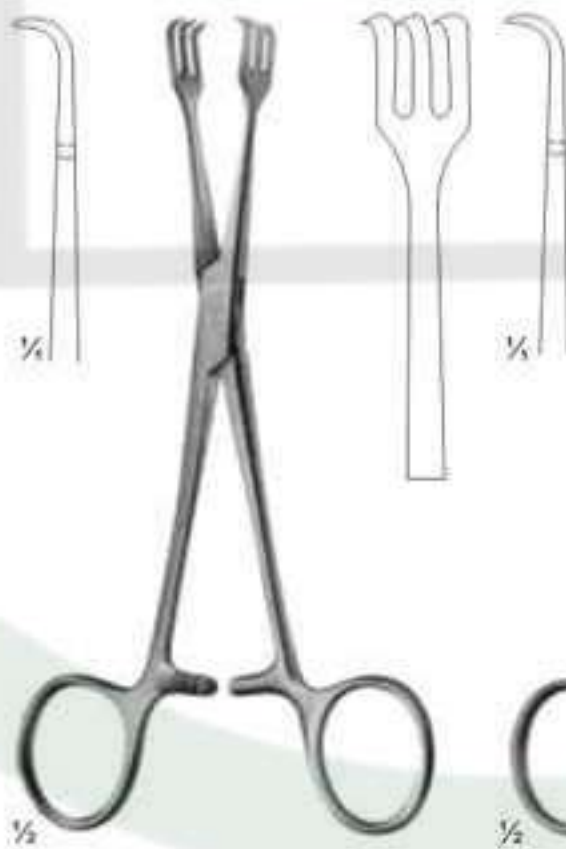

04-316
LAHEY
155 mm

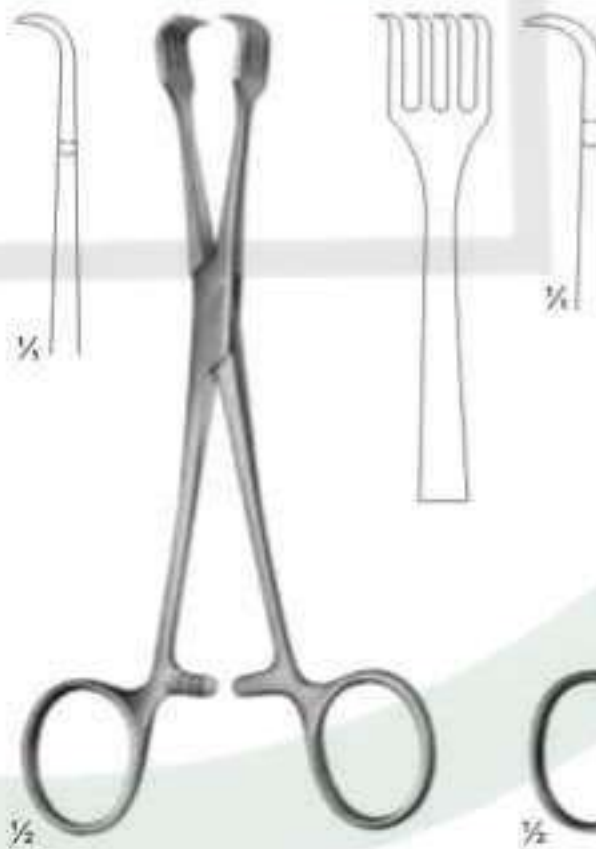

04-317
BRAUN
155 mm

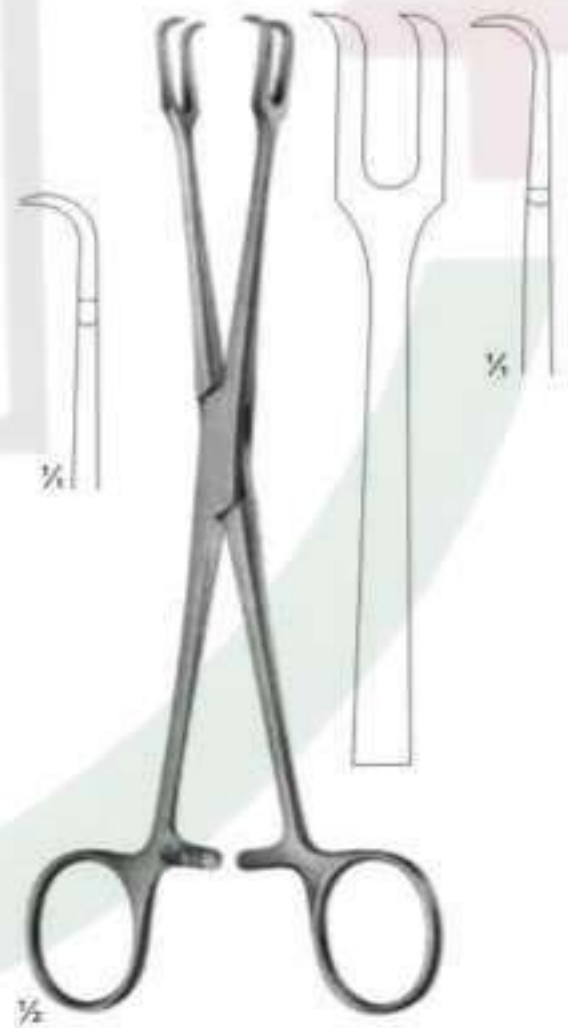

04-318
MUSEUX
200 mm



Towel Clamps

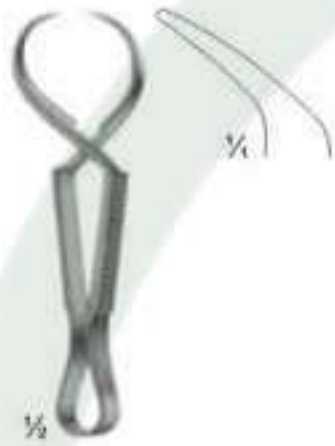

04-319
JONES
85 mm



04-320
ENGL. MOD.
85 mm

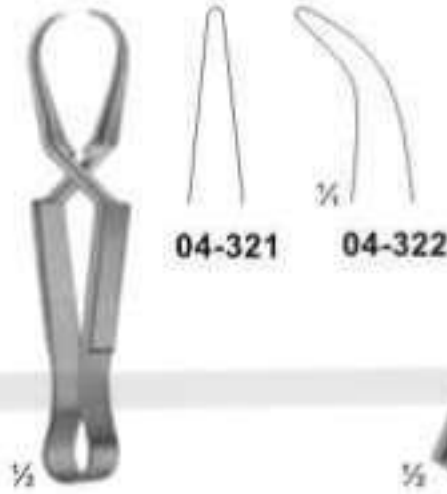

04-321 - 04-322
SCHAEDEL
85 mm



04-323
DOYEN
110 mm



04-324
DOYEN
180 mm

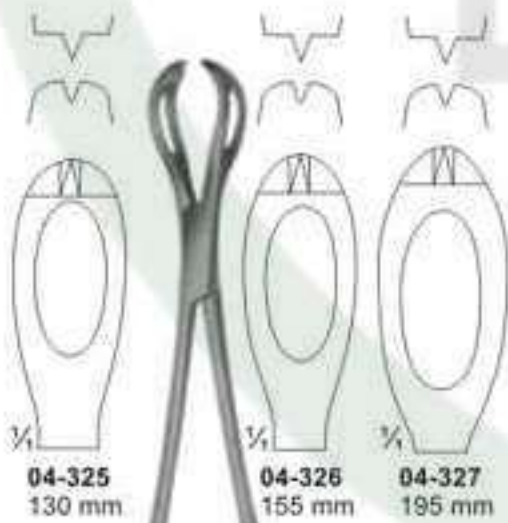

04-325 - 04-327
LANE



04-328 - 04-329
BACKHAUS

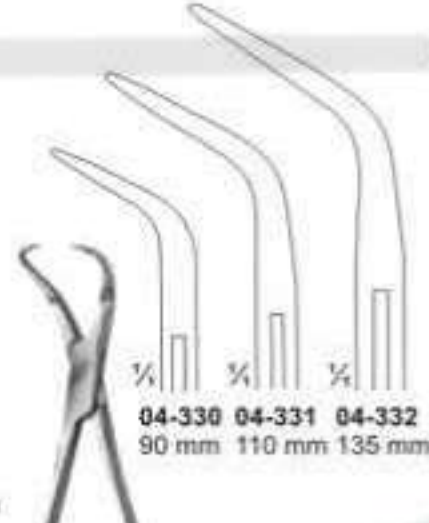

04-330 - 04-332
BACKHAUS



04-333
BACKHAUS-KOCHER
135 mm



04-334
ROEDER
135 mm



Muller Vessel Clips and Bulldog Clamps

Closing force

04-335 straight 80g 50g

04-336 curved 80g 50g

04-337 curved tips 80g 50g

04-338 angled shaped 80g 50g

04-339 MULLER knee-bent 80g 50g

04-340 Muller Ligature Forceps

Jaw, cross serrated

04-341 35 mm

04-342 35 mm

04-343 45 mm

04-344 45 mm

04-345 DIEFFENBACH 38 mm

04-346 DIEFFENBACH 48 mm

04-347 DIEFFENBACH 38 mm

04-348 DIEFFENBACH 48 mm

04-349 DIEFFENBACH 58 mm

04-350 DIEFFENBACH 58 mm

04-351 - 04-357 JOHNS-HOPKINS 91 mm

04-351 38 mm

04-352 48 mm

04-353 56 mm

04-354 63 mm

04-355 70 mm

04-356 80 mm

04-357 91 mm

04-358 DE BAKEY-HESS 20 mm

04-359 DE BAKEY length 50 mm jaws 27 mm

04-360 DE BAKEY length 48 mm jaws 27 mm

04-361 GLOVER length 57 mm jaws 35 mm

04-362 DE BAKEY length 73 mm jaws 38 mm

04-363 DE BAKEY length 99 mm jaws 63 mm

04-364 DE BAKEY length 95 mm jaws 54 mm

04-365 DE BAKEY L. 80 mm

04-366 DE BAKEY L. 90 mm

04-367 DE BAKEY L. 105 mm

04-368 DE BAKEY L. 124 mm

04-369 DE BAKEY L. 78 mm

04-370 DE BAKEY L. 86 mm

04-371 DE BAKEY L. 97 mm

04-372 DE BAKEY L. 114 mm

04-373 GLOVER L. 68 mm

04-374 GLOVER L. 96 mm

04-375 GLOVER L. 117 mm

04-376 GLOVER L. 65 mm

04-377 GLOVER L. 91 mm

04-378 GLOVER L. 110 mm



Delicate Haemostatic Forceps



04-379 - 04-382
HALSTED-MOSQUITO
200 mm

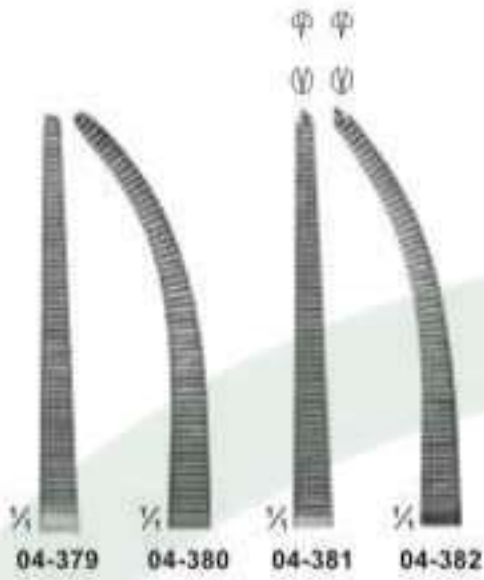

04-383 - 04-387
HEISS
200 mm

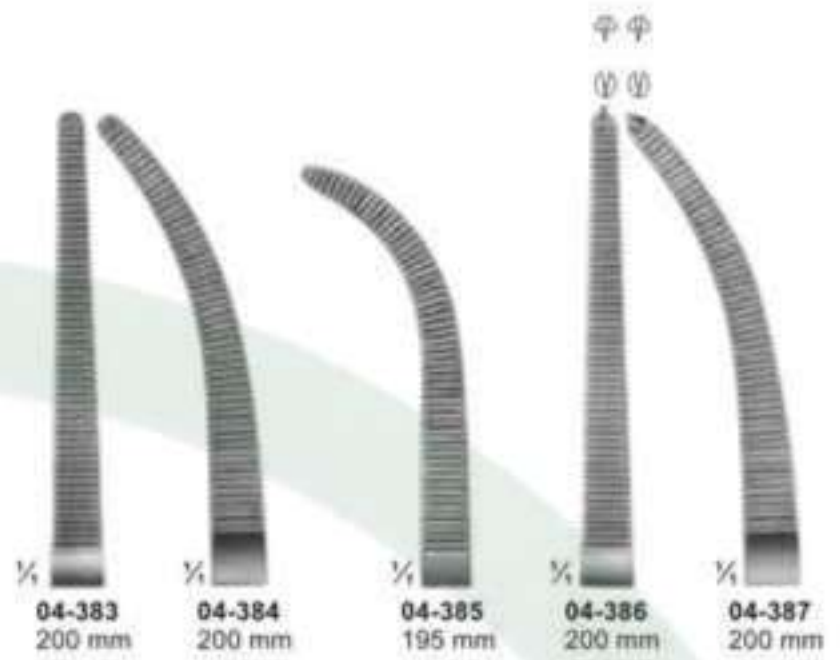

04-388 - 04-389
HALSTED
215 mm

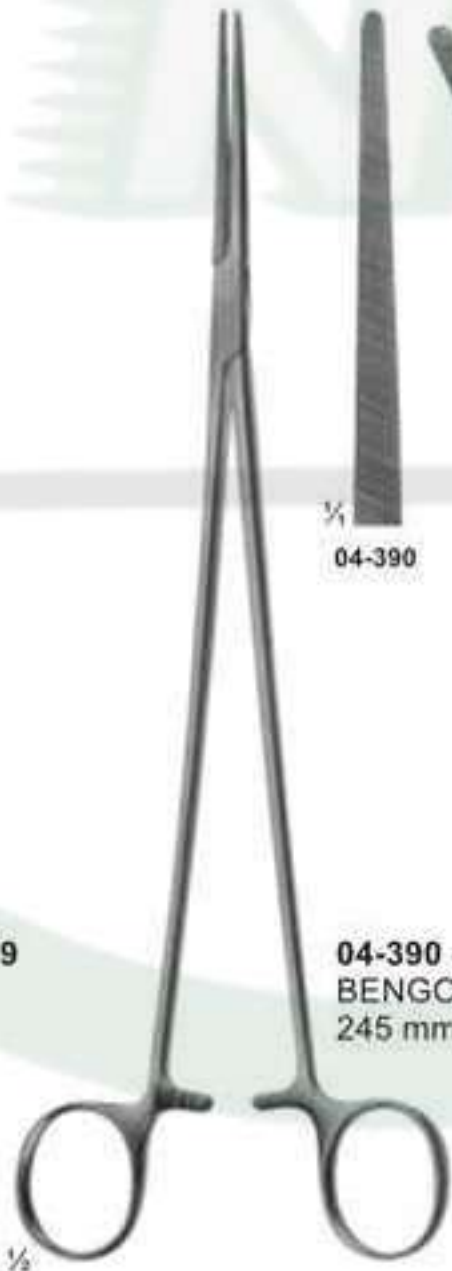

04-390 - 04-393
BENGOLEA
245 mm

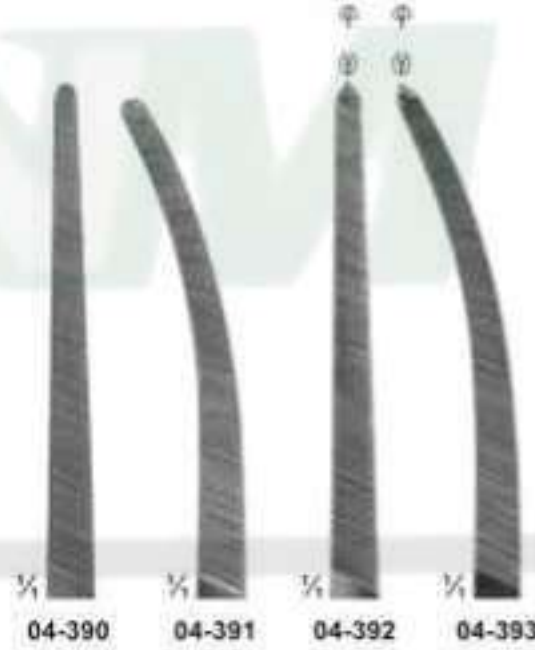

04-394
CRAFOORD
245 mm





Delicate Haemostatic Forceps



04-395
CARREL
85 mm



04-396 - 04-399
BABY-MOSQUITO
(HARTMANN)
100 mm



04-400 - 04-403
MICRO-HALSTED
125 mm



04-404 - 04-407
HALSTED-MOSQUITO
125 mm

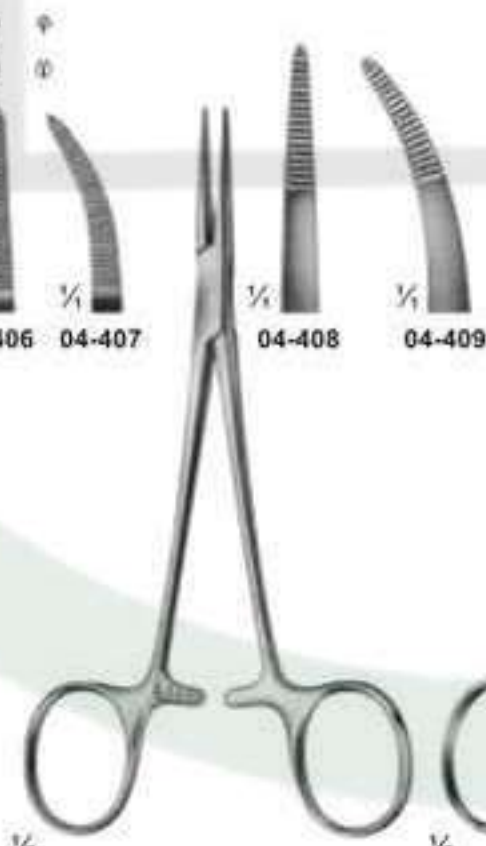

04-408 - 04-409
PROVIDENCE-HOSPITAL
140 mm

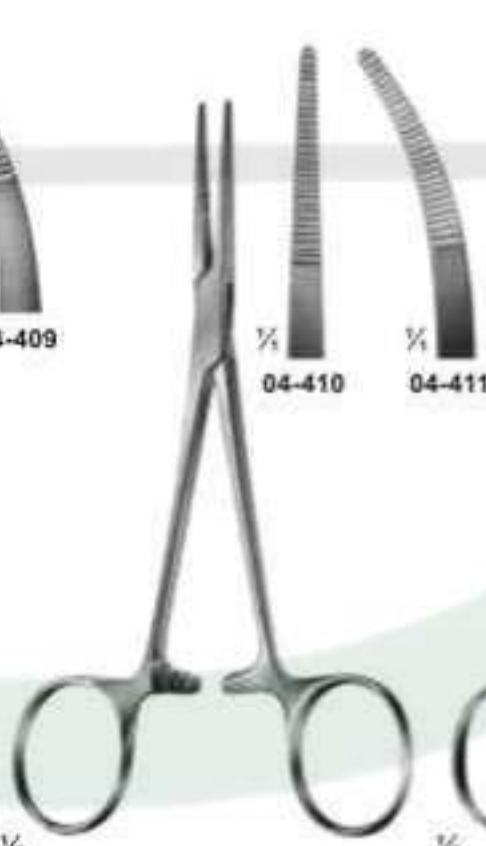

04-410 - 04-411
KELLY
140 mm



04-412 - 04-413
DANDY
Curved sideways
140 mm



Delicate Haemostatic Forceps

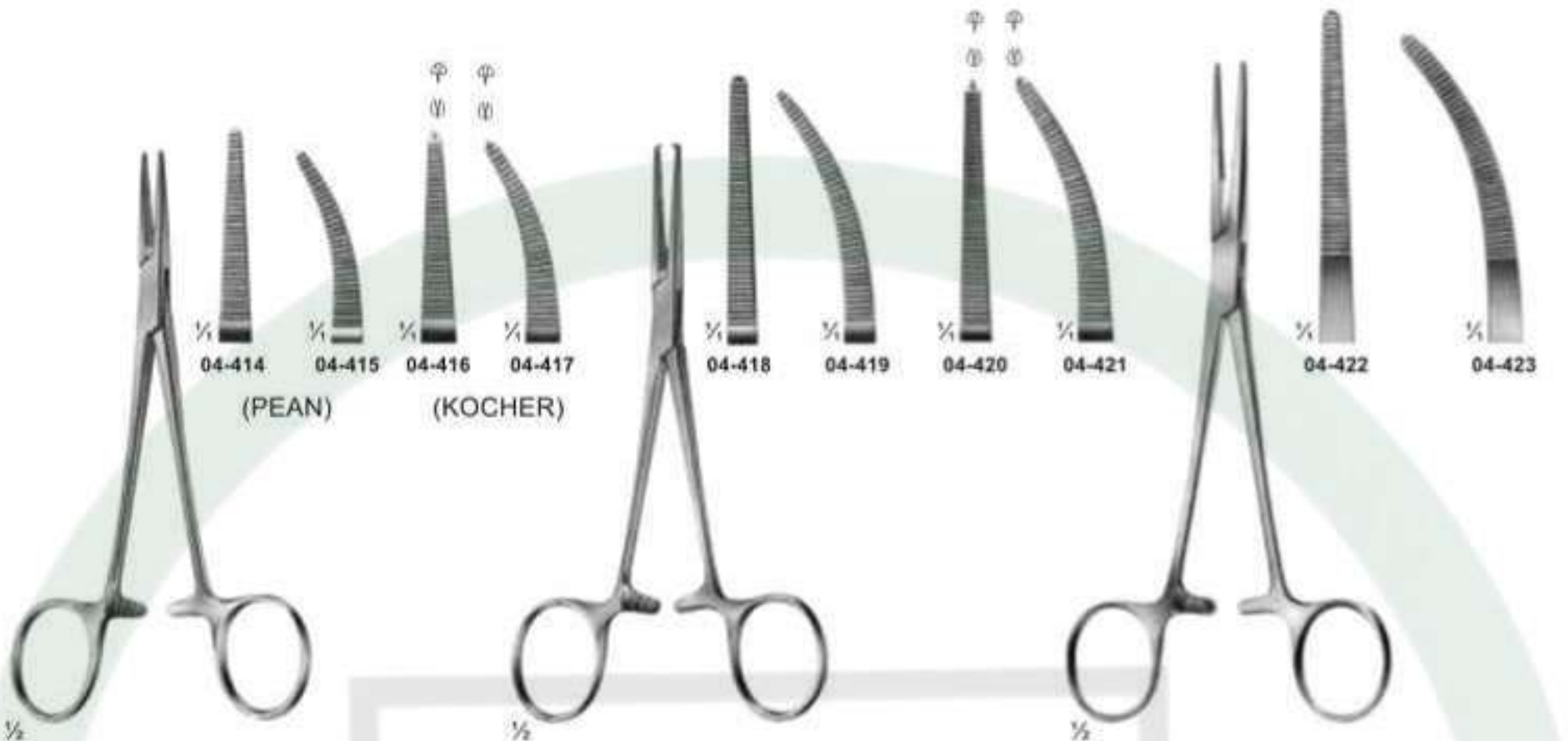

04-414 - 04-417
BABY-CRILE
140 mm

04-418 - 04-421
CRILE
140 mm

04-422 - 04-423
RANKIN
160 mm

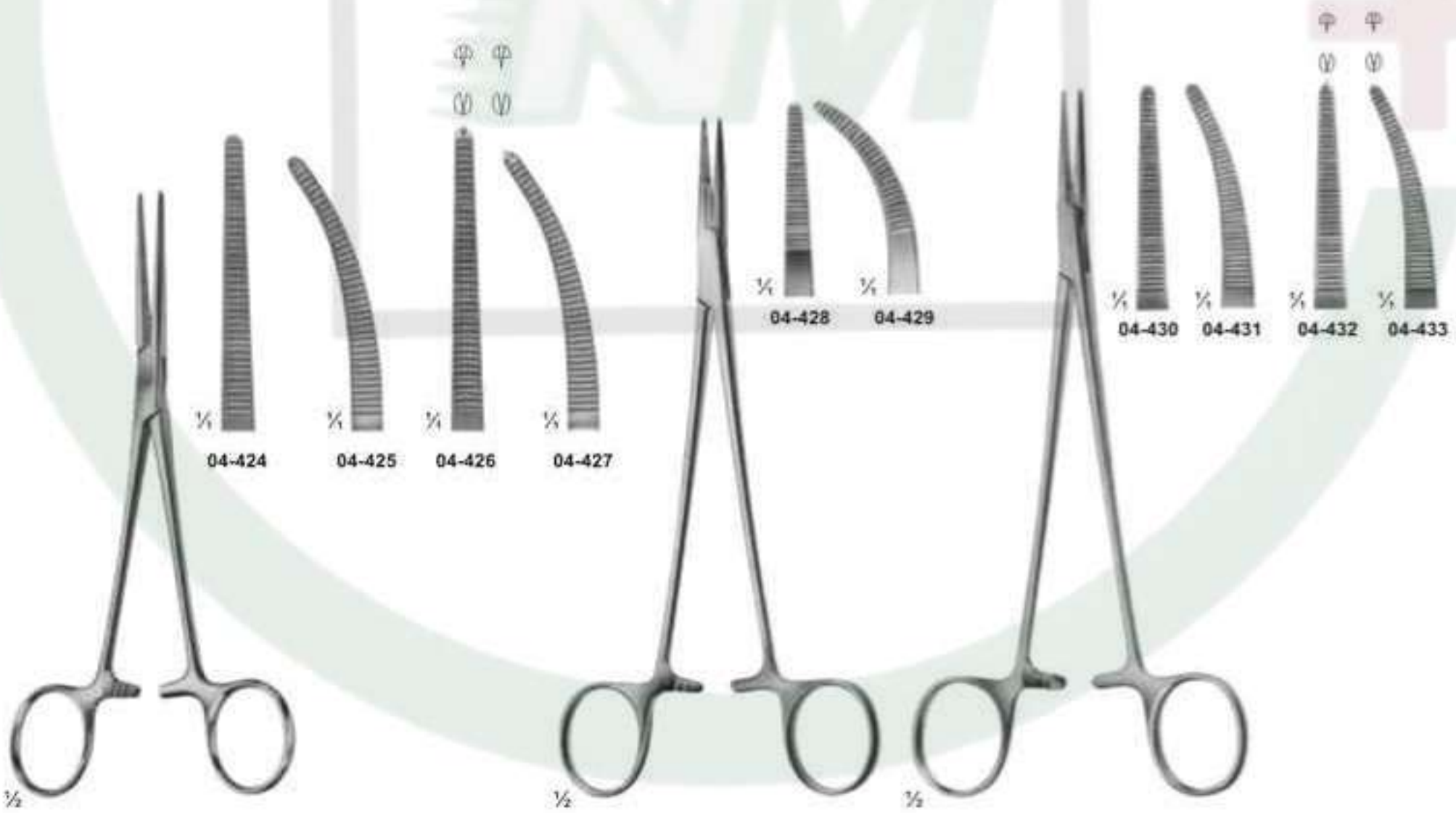

04-424 - 04-427
CRILE
160 mm

04-428 - 04-429
ADSON
185 mm

04-430 - 04-433
HALSTED
185 mm



Haemostatic Forceps



04-434 - 04-437
PEAN
Slender type

04-438 - 04-445
SPENCER-WELLS
Slender type

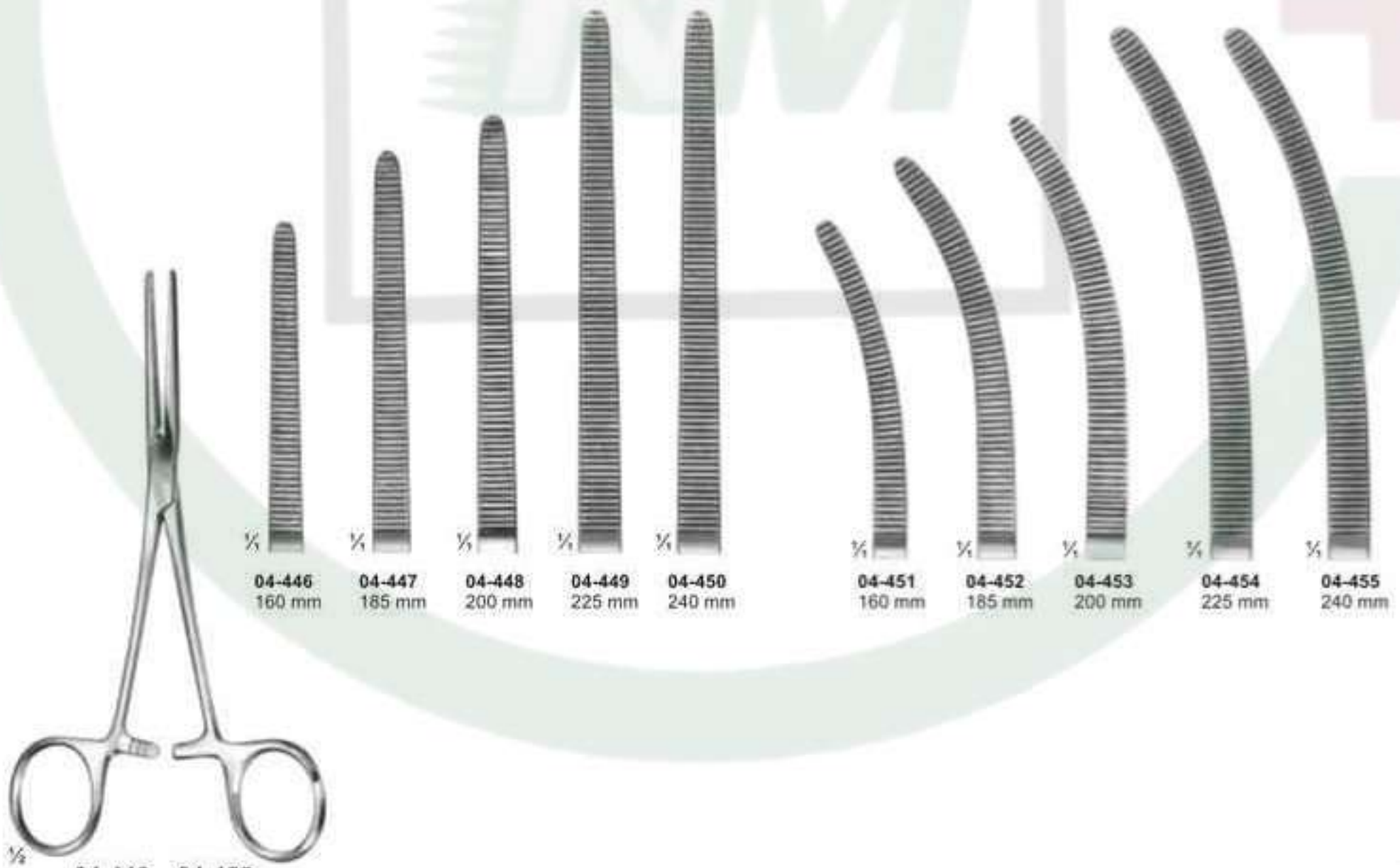

04-446 - 04-455
ROCHESTER-PEAN



Haemostatic Forceps



04-456 - 04-461
PEAN

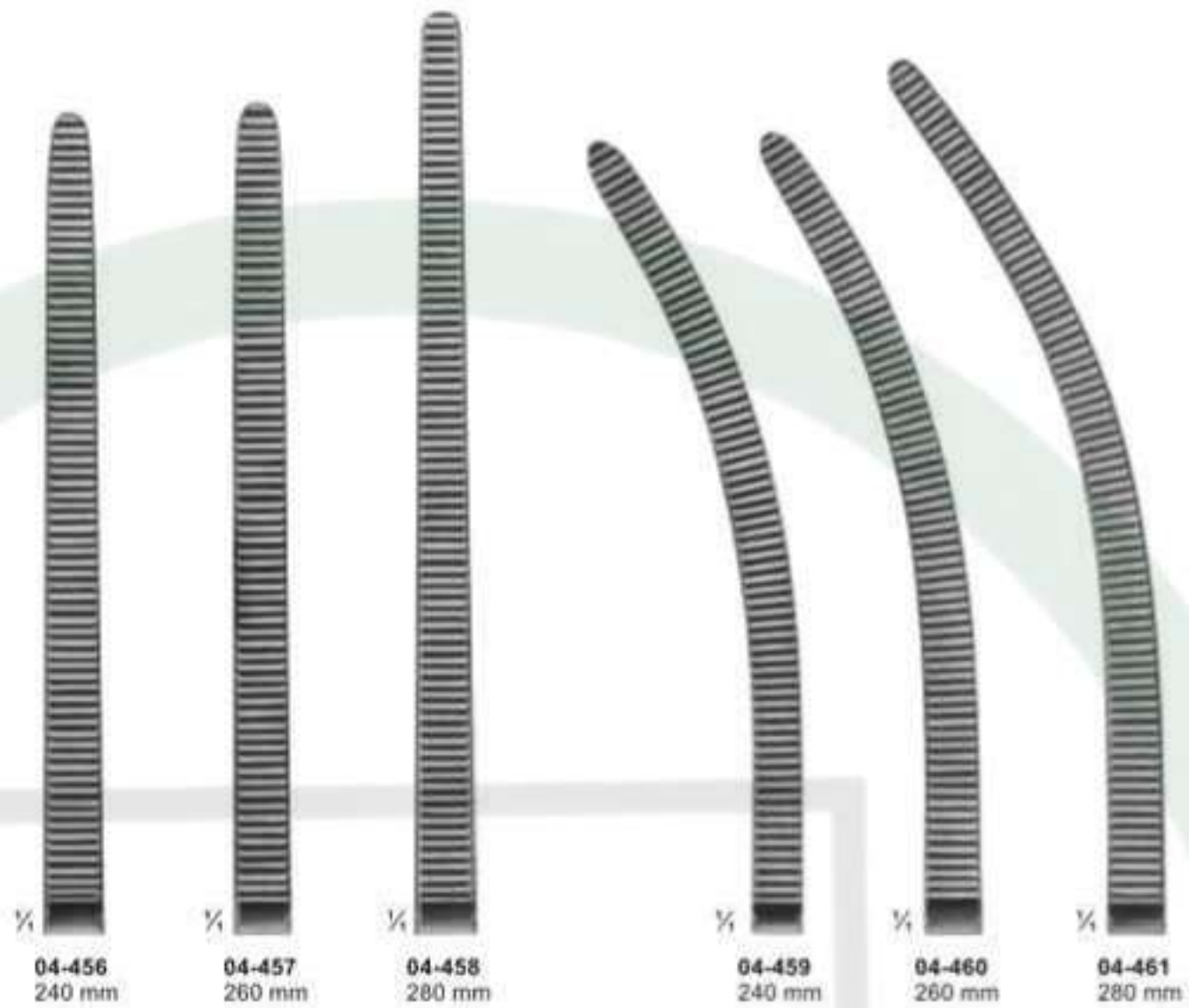

04-462
KOCHER
Strong Pattern
145 mm

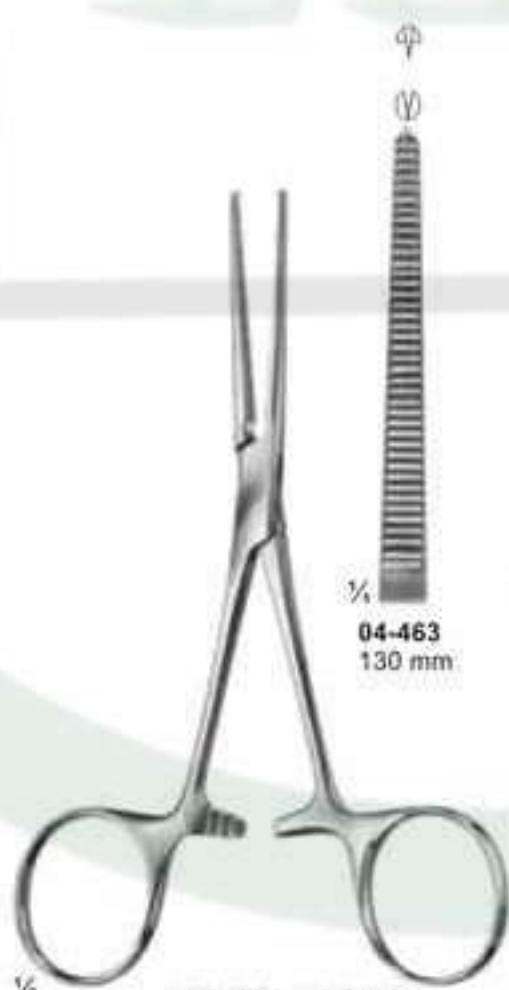

04-463 - 04-465
KOCHER

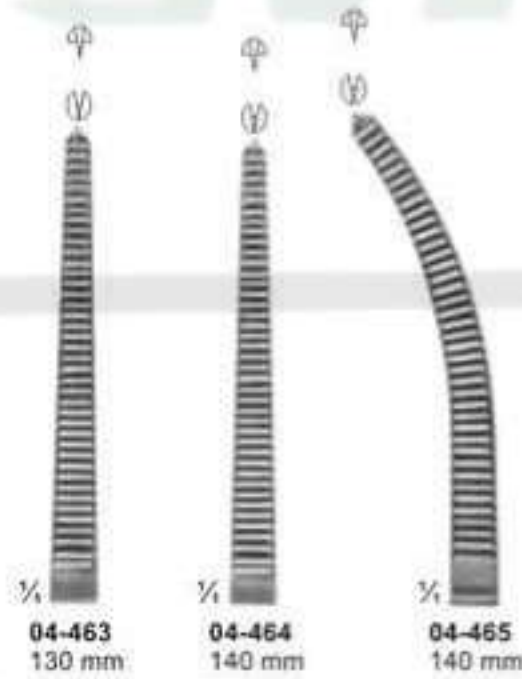

04-466 - 04-467
ROCHESTER-OGHSNER
140 mm





Haemostatic Forceps

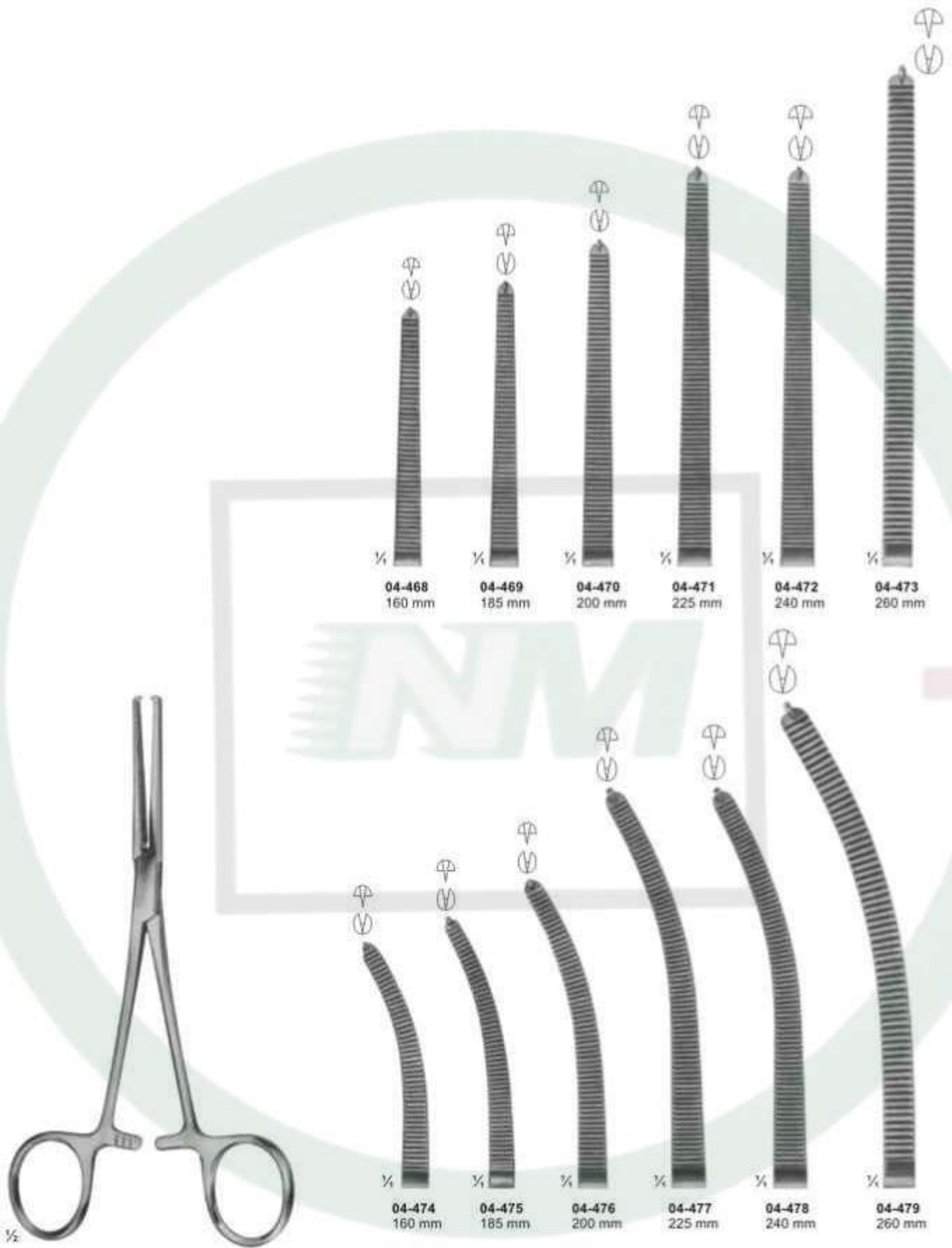

04-468 - 04-479
KOCHER-OCHSNER



Haemostatic Forceps



04-480
FRICKE
Artery forceps
130 mm



04-481
KRONLEIN
130 mm



04-482
PEAN
125 mm



04-483 - 04-484
PEAN



04-484
140 mm

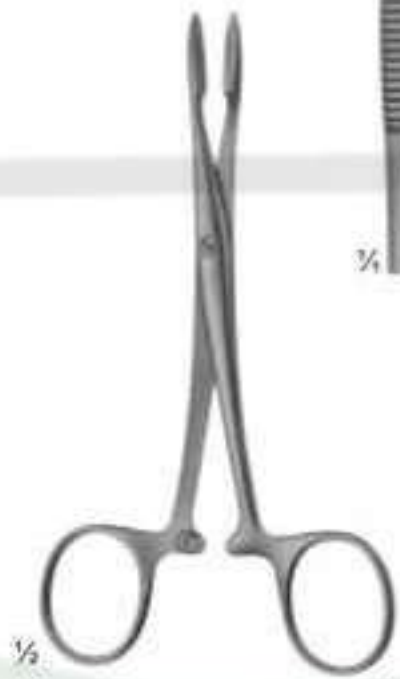

04-485
PEAN
125 mm



04-485



04-486 - 04-487
PEAN



04-486
165 mm



04-487
185 mm



Haemostatic Forceps, Special Pattern, Tonsil Forceps

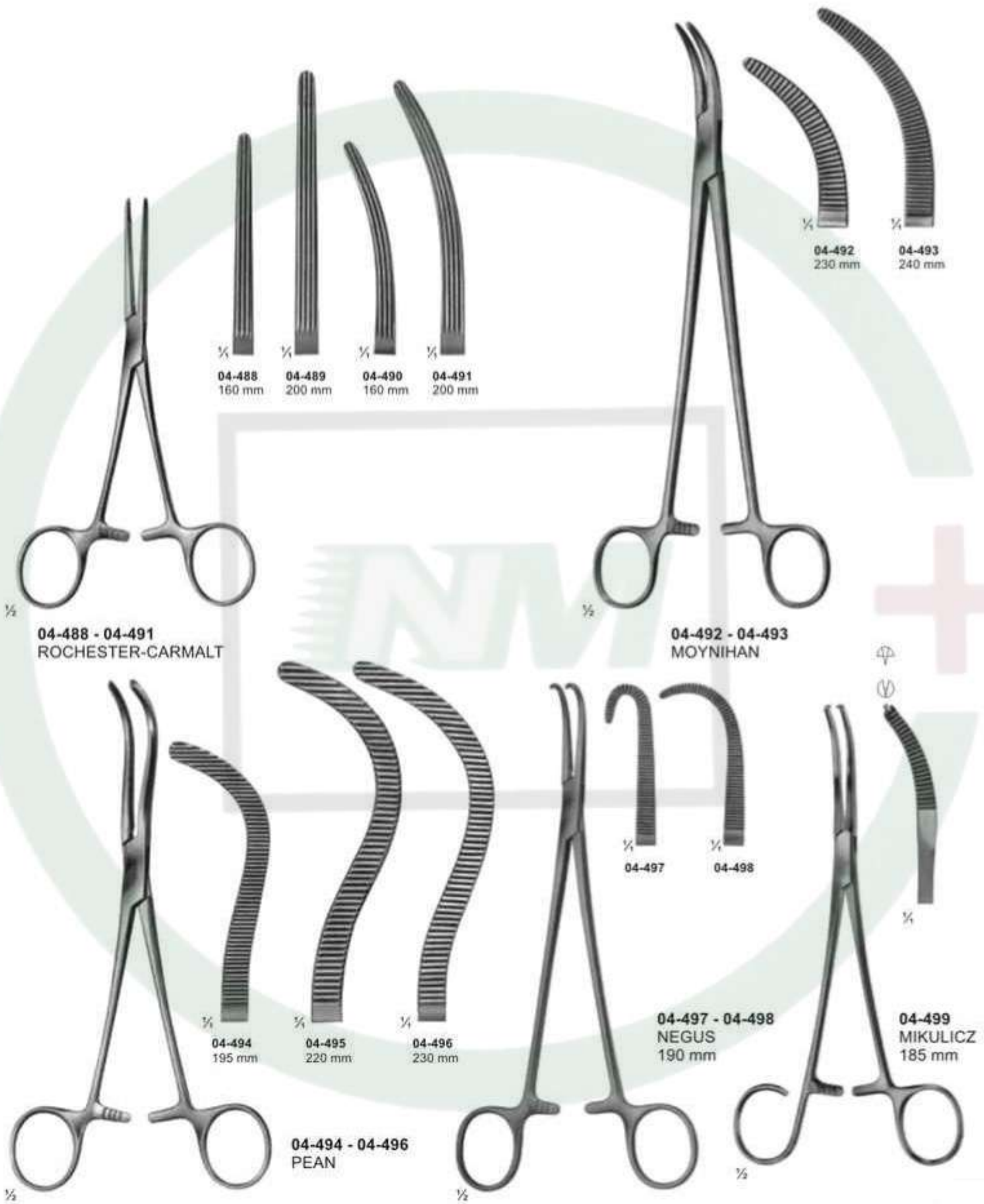



Dissecting- and Ligature Forceps

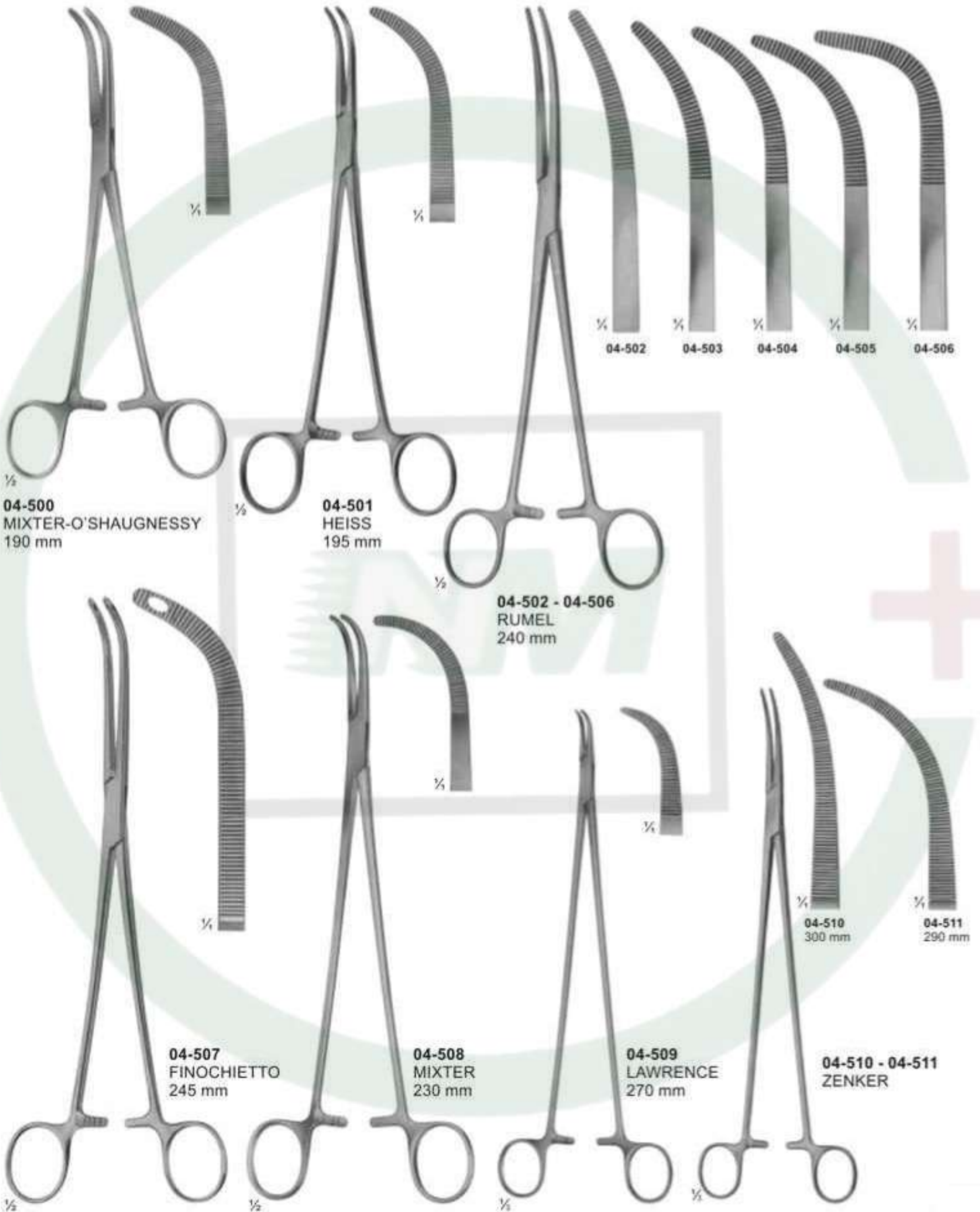



Hysterectomy Forceps, Vaginal Clamps and Compression Forceps

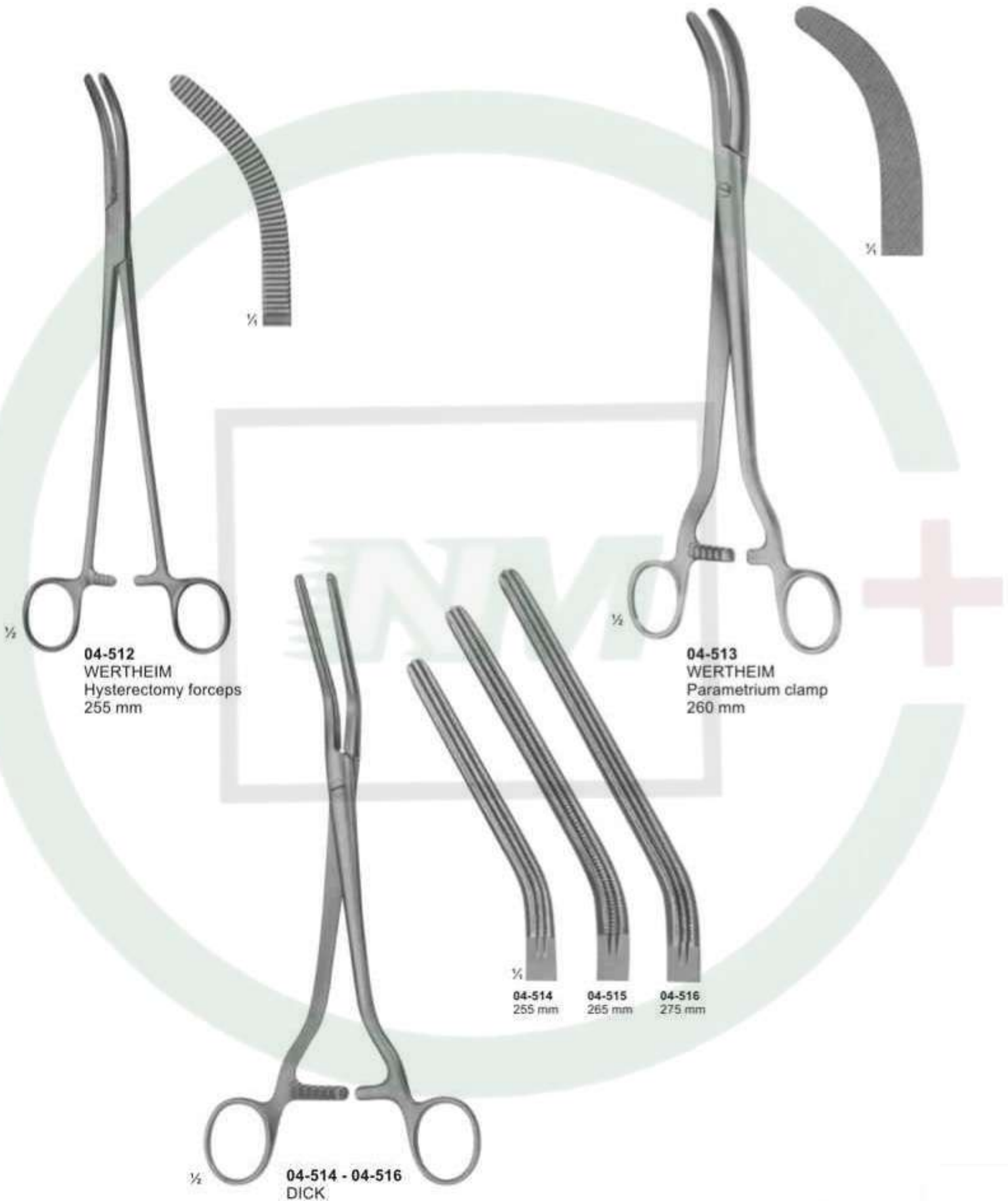

½
04-512
WERTHEIM
Hysterectomy forceps
255 mm

½
04-513
WERTHEIM
Parametrium clamp
260 mm

¼
04-514 255 mm
04-515 265 mm
04-516 275 mm

½
04-514 - 04-516
DICK



Hysterectomy Forceps, Vaginal Clamps and Compression Forceps

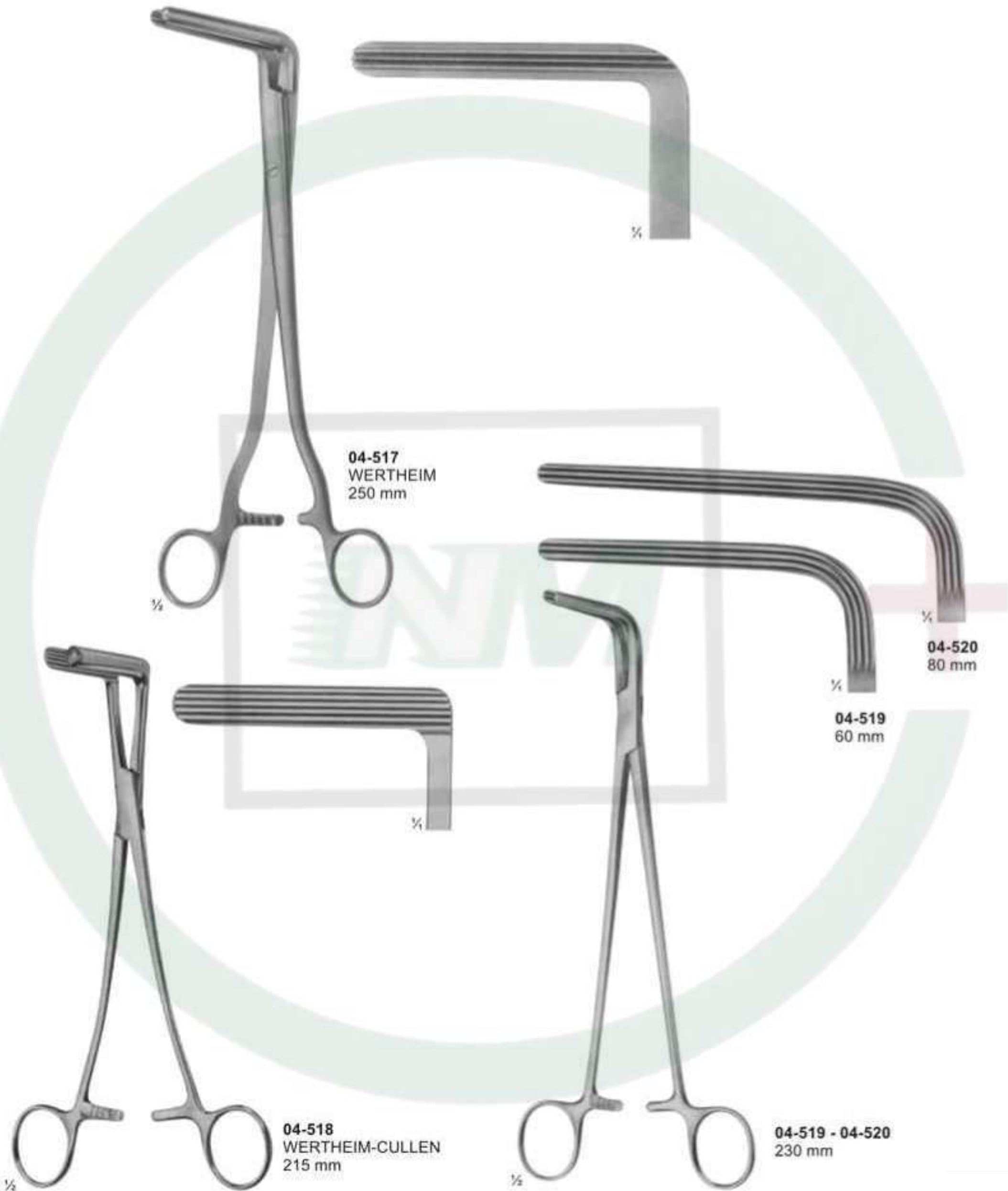



Needle Holders for micro surgery



05-101
ROHRSCHEIDER
with copper inserts
100 mm



05-102
KALT
with catch
135 mm



05-103
ARRUGA
with catch
135 mm



05-104 - 105
CASTROVIEJO
with catch
145 mm



05-106 - 107
without Catch
160 mm



05-108 - 109
without catch
185 mm



05-109



05-110 - 111
JACOBSON
185 mm

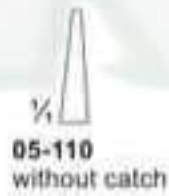

05-110
without catch



05-111
with catch



05-112
without catch
195 mm



05-113 - 114
YASARGIL
with catch
200 mm

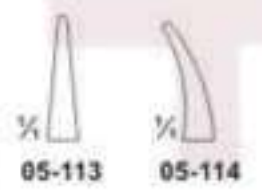

05-113



05-114



Needle Holders





Needle Holders





Needle Holders

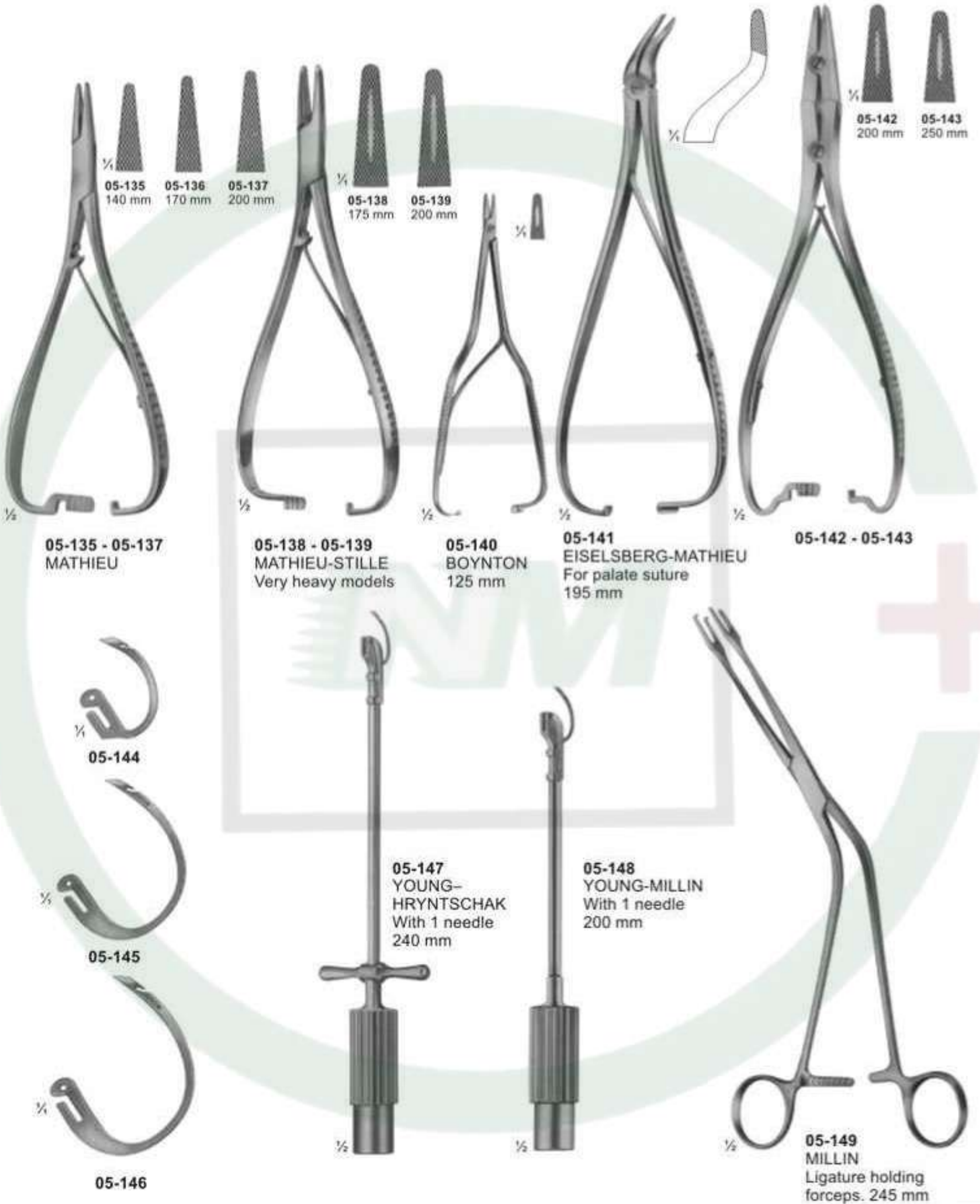



Suture Instruments - Reverdin Needles

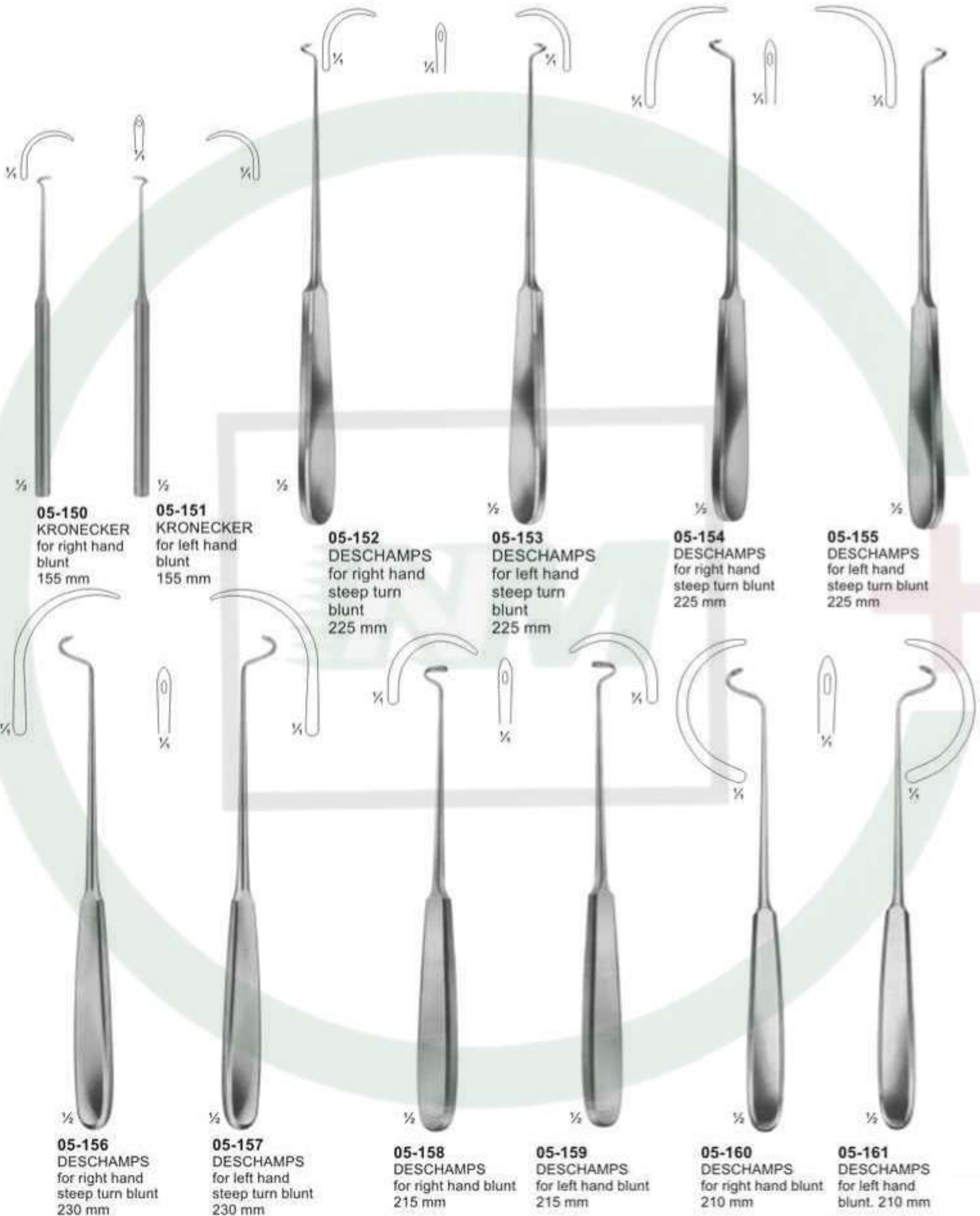



Probes



05-162 130 mm
05-163 145 mm
05-164 160 mm
Directors



05-165
DOYEN
145 mm
Directors



05-166
NELATON
160 mm
Directors



05-167
Director with tip
Diam. Of tip 3,3 mm
140 mm



05-168
BRODIE
Director with tip,
Diam. Of tip 3,5 mm
200 mm



05-169
LOCKHART-MUMMERY
165 mm



05-170
LOCKHART-MUMMERY
165 mm

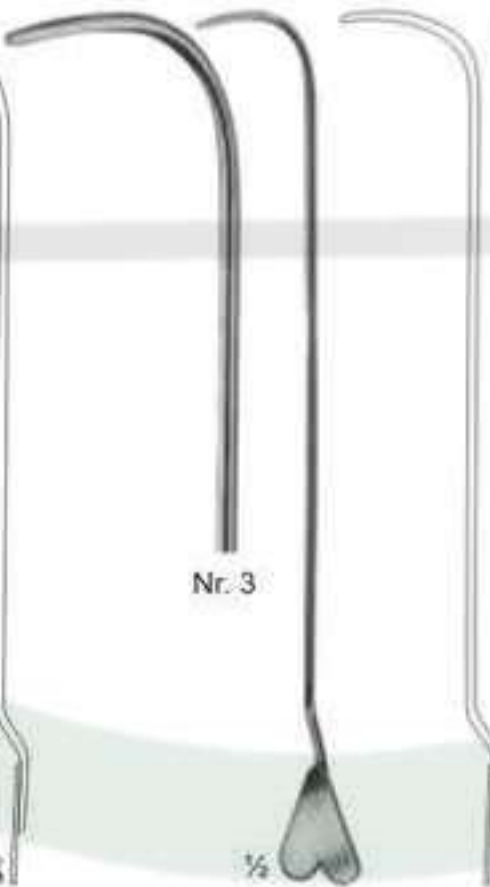

05-171
LOCKHART-MUMMERY
165 mm

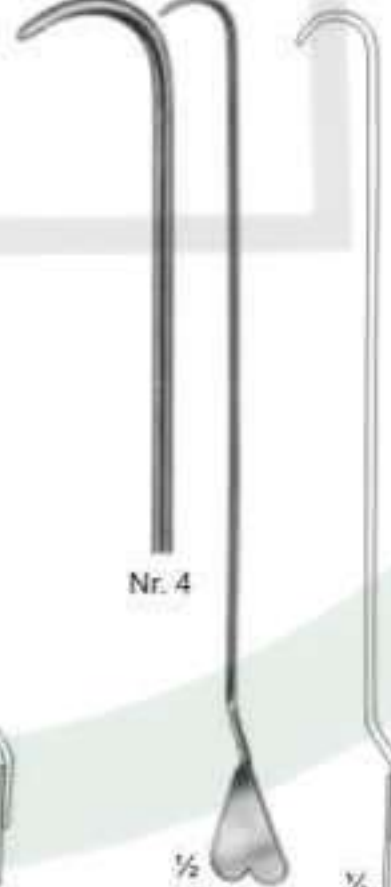

05-172
LOCKHART-MUMMERY
165 mm



05-173
Director with wire
loop, malleable
190 mm



Probes

05-174
2,5 mm
05-175
2,5 mm
05-176
3,0 mm



05-174 145 mm
05-175 160 mm
05-176 200 mm
Probes with eye

1,5 mm



05-177
Myrtle leaf probe
145 mm

2,0 mm



05-178 130 mm
05-179 145 mm
05-180 160 mm
05-181 180 mm
05-182 200 mm

05-183
Probes



05-184 1/2
Double ended probe,
malleable, diam. of tips
3 mm with hole
190 mm



05-185
Double ended probes,
tin, malleable,
diam. of tips
3,5 mm with hole
250 mm. 300 mm



05-186 1/4
Double ended probes,
tin, malleable,
diam. of tips 4 mm
400 mm



1/2 ∅ tip
05-187 1,5 mm
05-188 2,0 mm
05-189 2,5 mm
300 mm





Suturing Instrument Set, Pocket Instrument Set



05-190

Suturing instruments set, in metal case consisting of: Scissors, curved, sharp/sharp, 115mm
25 MICHEL clip, 16 x 3mm
1 Delicate tissue forceps, 130mm
1 Scalpel, bellied
1 MATHIEU needle holder, 140mm
1 Perforated metal case, stainless containing:
1 Suture needle
1 item 1 item



05-191

Pocket instrument set, in metal case consisting of:

Bottom tray

1 MATHIEU needle holder, 140mm
1 MICHEL clip forceps, combined
1 Myrtle leaf probe, 130mm
1 Sharp double curette
1 Skin hook
1 Detachable scalpel handle, no.4
1 Perforated metal case, containing
6 Scalpel blades
1 Perforated metal case, stainless, containing
1 Suture needle
1 item
1 item

Top tray

1 Tissue forceps, 130mm
1 KOCHER haemostatic forceps, 130mm
1 Straight surgical scissors, 130mm
1 Dissecting forceps, 130mm
1 FEILCHENFELD splinter forceps, 115mm
25 MICHEL clip, 16 x 3mm
1 Flacon of suture skin, sterile in alcohol



05-192

Pocket instrument set, in metal case consisting of:

Bottom tray

1 MAYO-HEGER needle holder, 150mm
1 MICHEL clip forceps, combined
1 Myrtle leaf probe, 130mm
1 Sharp double curette
1 Skin hook
1 Detachable scalpel handle, no. 4
1 Perforated metal case, consisting
6 Scalpel blades
1 Perforated metal case, stainless, consisting:
1 Suture needle
1 item. & 1 item

Top tray

1 Tissue forceps, 130mm
1 CRILE haemostatic forceps, 140mm
1 Straight surgical scissors, 130mm
1 Dissecting forceps, 130mm
1 FEILCHENFELD splinter forceps, 115mm
25 MICHEL clip, 16 x 3mm
1 Flacon of suture silk, sterile in alcohol



Fine Wound Retractors (Dura- and Skin)

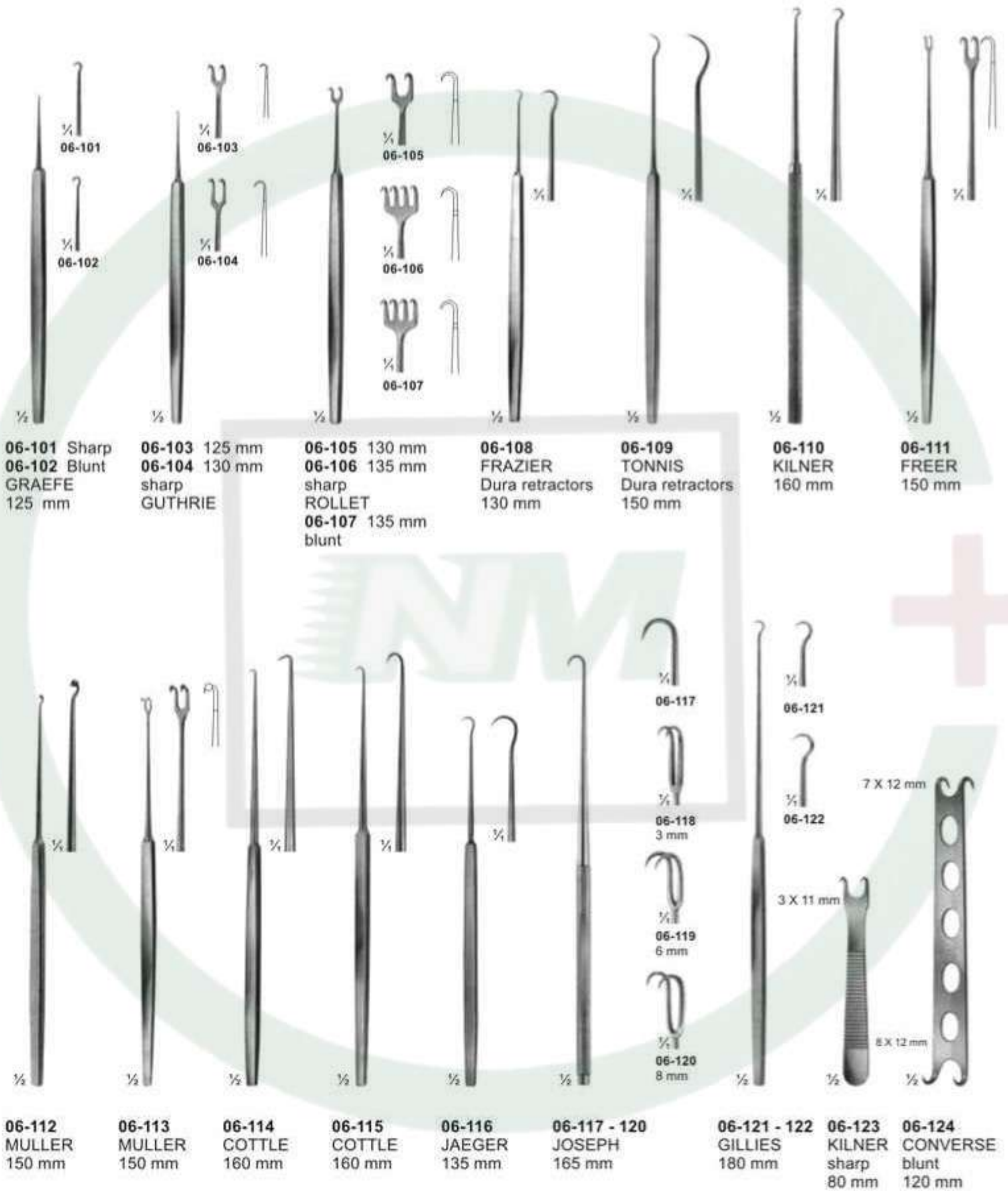



Retractors With triangle handle

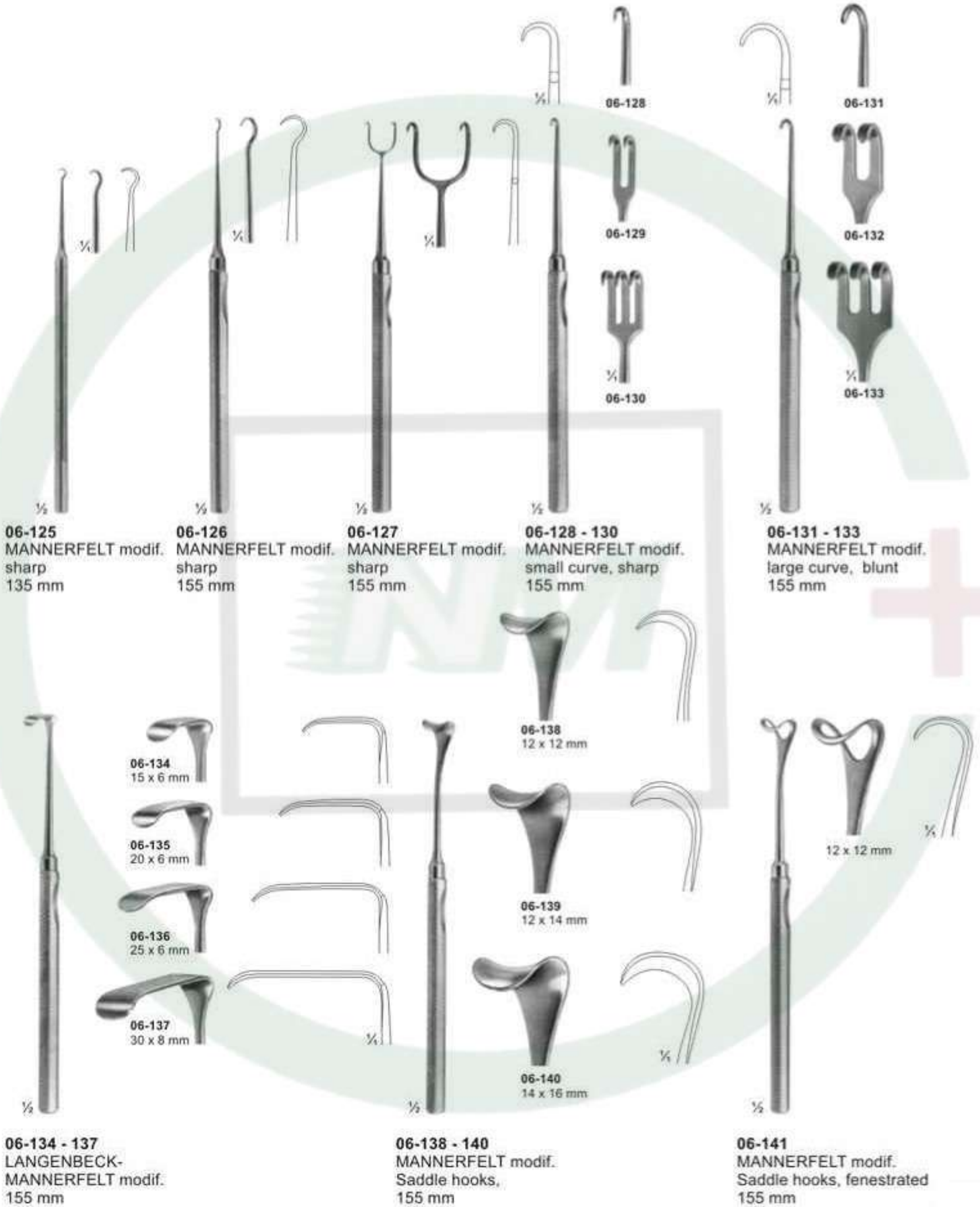



Retractors





Retractors





Retractors



06-169 - 06-170
BABY-SENN-MILLER
155 mm

06-171
SENN-MILLER
165 mm

06-172
COLLIN-HARTMANN
150 mm

STERBERG
06-173 120 mm
06-174 130 mm
06-175 135 mm
06-176 140 mm

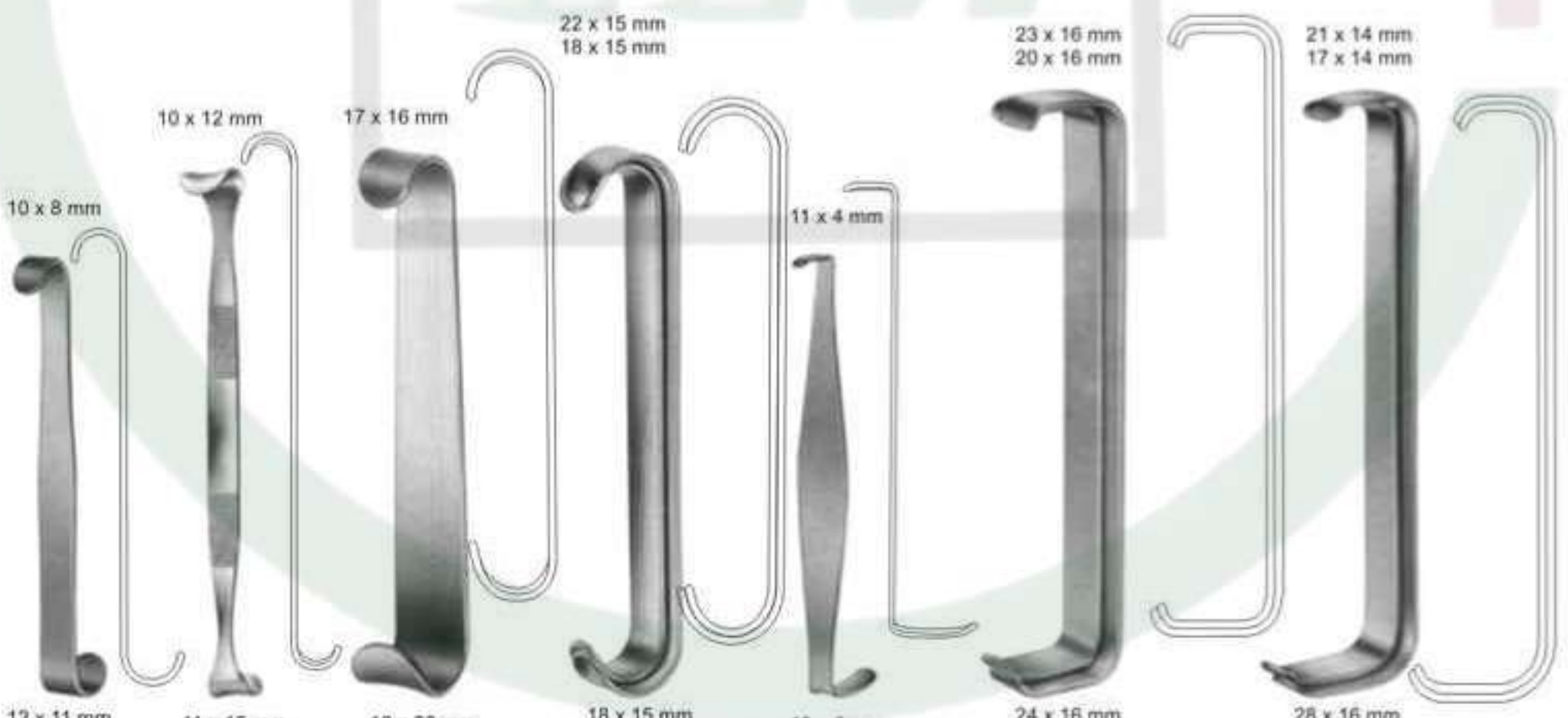

12 x 11 mm

11 x 15 mm

18 x 22 mm

18 x 15 mm
22 x 15 mm

19 x 6 mm

24 x 16 mm
28 x 16 mm

28 x 16 mm
32 x 16 mm

06-177
LUER
110 mm

06-178
ROSE
130 mm

06-179
BABY-ROUX
135 mm

06-180
PARKER
135 mm

06-181
CRILE
110 mm

06-182
FARABEUF
150 mm

06-183
COLLIN
150 mm



Bone Retractors and Retractors



06-184
KOCHER
sharp
205 mm



06-185
KOCHER
sharp
220 mm



06-186
KOCHER
sharp
220 mm



06-187
VOLKMANN
blunt
220 mm



06-188
VOLKMANN
sharp
220 mm



06-189 - 06-196
VOLKMANN
225 mm



Sharp

1/2



06-189
9 x 8 mm



06-190
9 x 13 mm



06-191
9 x 19 mm



06-192
9 x 29 mm

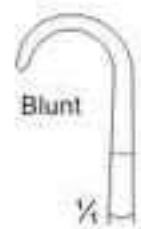

Blunt

1/2



06-193
8,5 x 8 mm



06-194
8,5 x 13 mm



06-195
8,5 x 19 mm



06-196
8,5 x 29 mm



Retractors

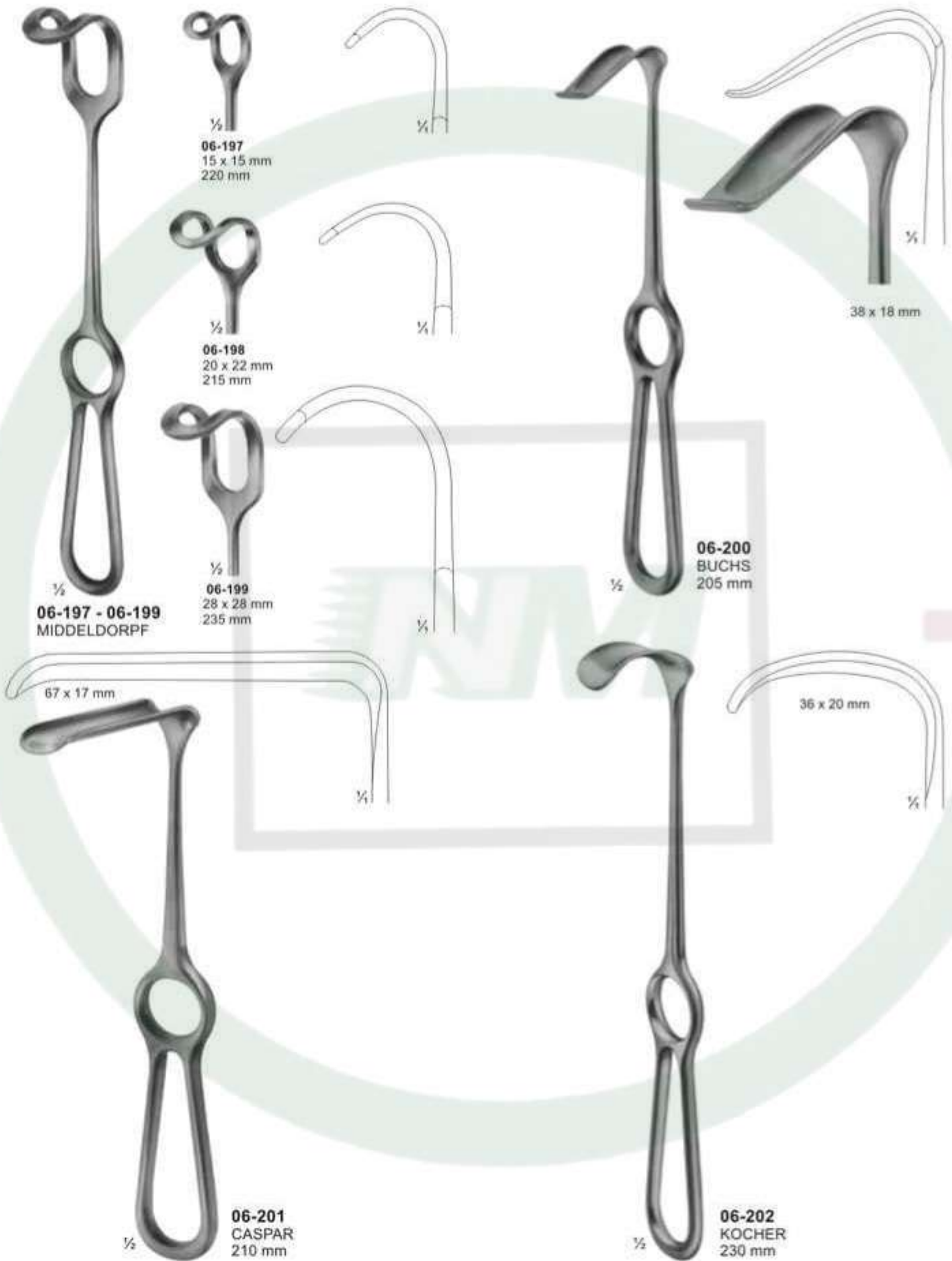



Retractors, Vario Retractor System



06-203 80 x 20 mm

06-203- 06-209
BRUNNER
275 mm
06-203 80 x 20
06-204 100 x 25
06-205 120 x 25
06-206 130 x 30
06-207 140 x 30
06-208 160 x 30
06-209 180 x 30

06-210
Handle with cold
light carrier for
retractor blades.
280 mm

Handle arrange-
ment verriable



Retractors, Lung Spatulas

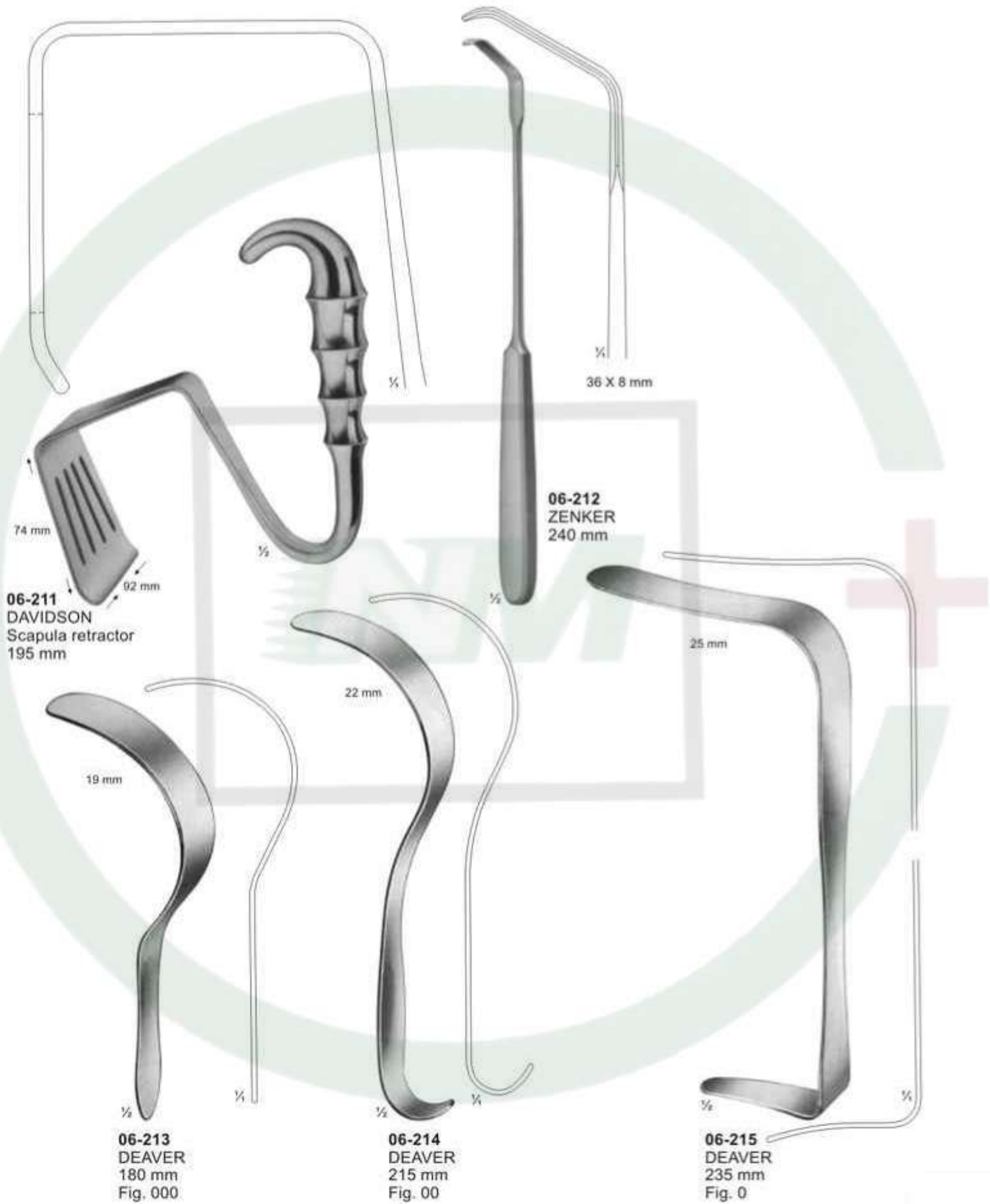



Retractors for deep surgery (Abdominal Retractors)





Retractors, Abdominal Retractors



length of blades	width of blades
62 mm	35 mm, 45 mm, 60 mm.
92 mm	06-218, 06-222, 06-226
122 mm	06-219, 06-223, 06-227
160 mm	06-220, 06-224, 06-228
	06-221, 06-225



Abdominal- and Intestinal Spatulas Bauch- und Darmspatel



06-235
LERICHE
255 mm

06-236
KUMMEL
Mealleable
285 mm

06-237
MIKULICZ
29 mm
250 mm

06-238 - 06-239
KADER
06-238 30 mm
06-239 40 mm
270 mm



Self-Retaining Retractors

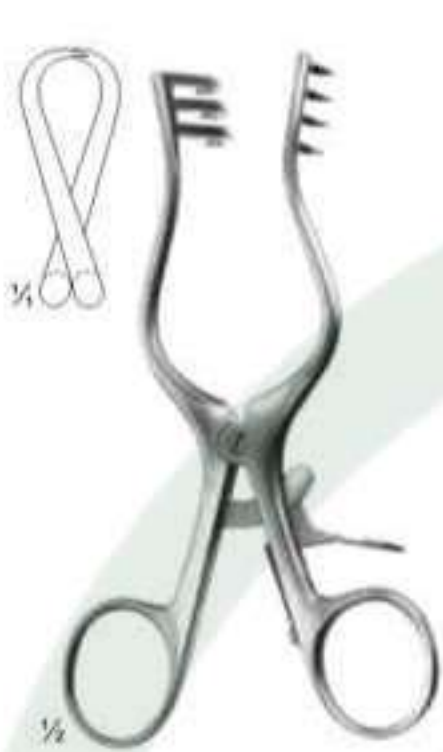

06-240
WEITLANER
sharp
130 mm

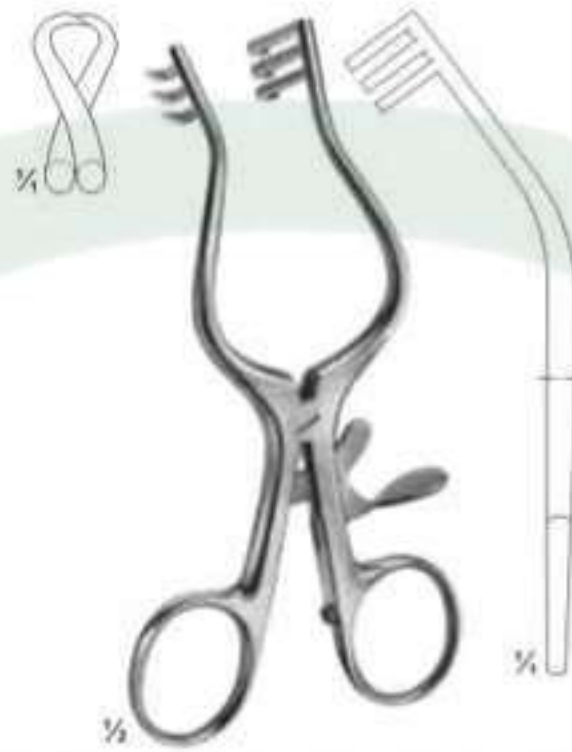

06-241
WULLSTEIN
sharp
130 mm

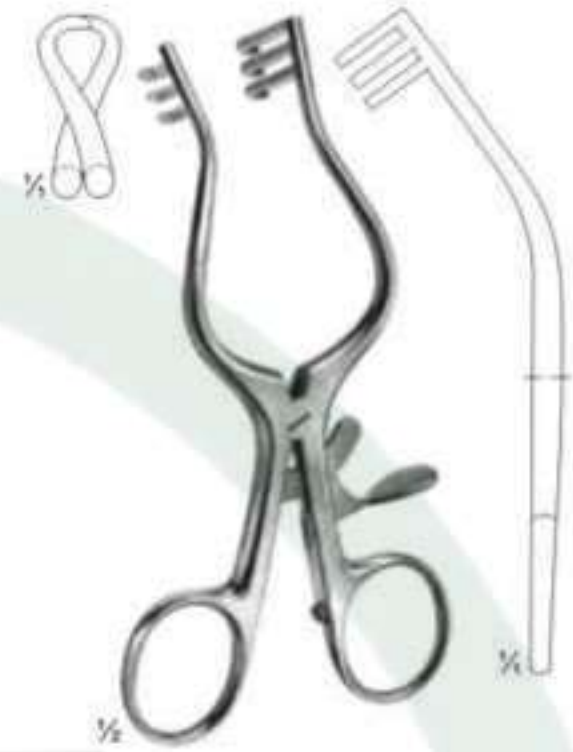

06-242
WULLSTEIN
blunt
130 mm



06-243
WEITLANER
sharp
165 mm

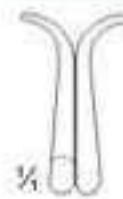

06-244
PLESTER
blunt
110 mm



06-245
PERKINS
130 mm



Special Retractors



06-246
JOLL (FRIEDMAN)
Thyroid- and vaginal retractor
155 mm



06-247
JACKSON BURROWS
Retractor, blunt
185 mm



06-248
GELPI
Vaginal retractor
135 mm



06-249
GELPI
Skin- and vaginal retractor
175 mm



06-250
DE BAKEY
Femur retractor
145 mm



Lamina Spreaders



06-251
CLOWARD
155 mm



06-252
CLOWARD
135 mm



06-253
INGE
170 mm

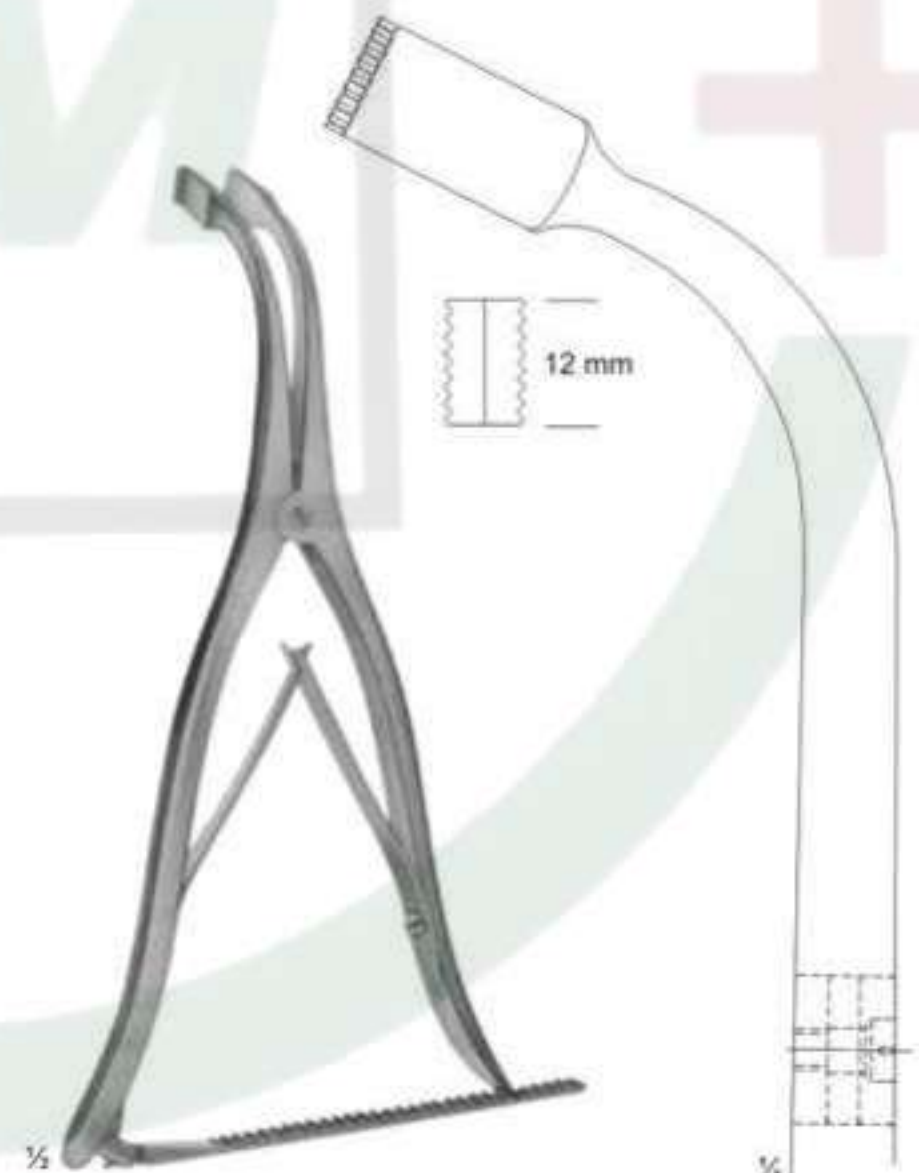

06-254
INGE
275 mm



Abdominal Retractors



06-255
GOSSET
Blades: 38 mm deep

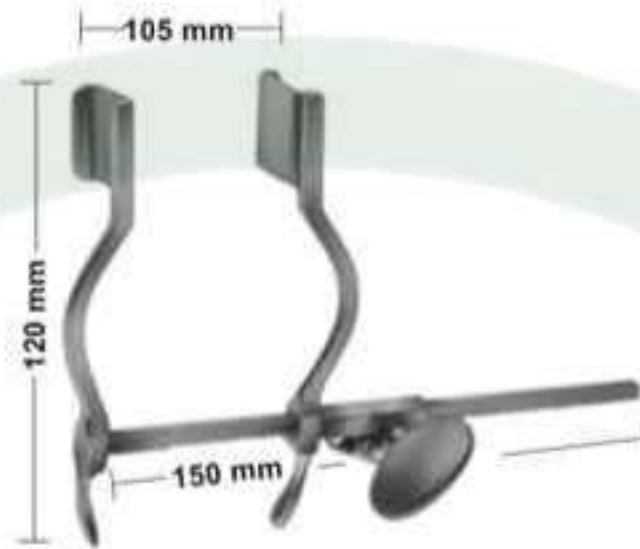

06-256
HERTZLER
Blades 20 X 25 mm

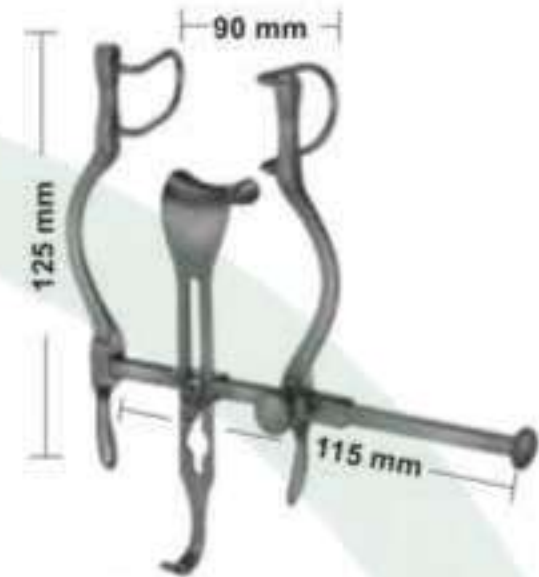

06-257
BALFOUR-BABY
Lateral blades 27 mm deep
Center blade 21x24 mm

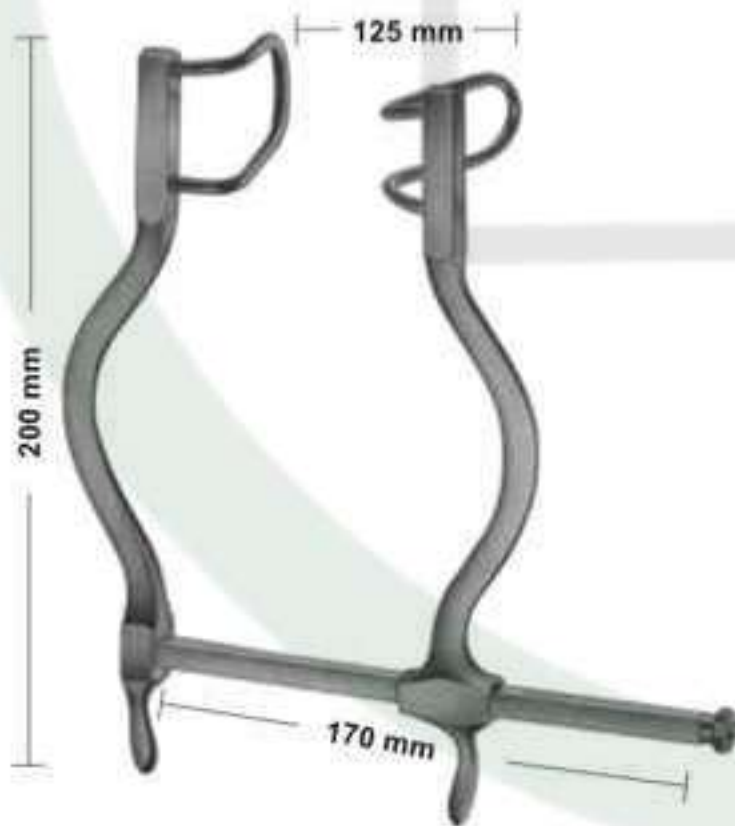

06-258
GOSSET
Blades: 55 mm deep

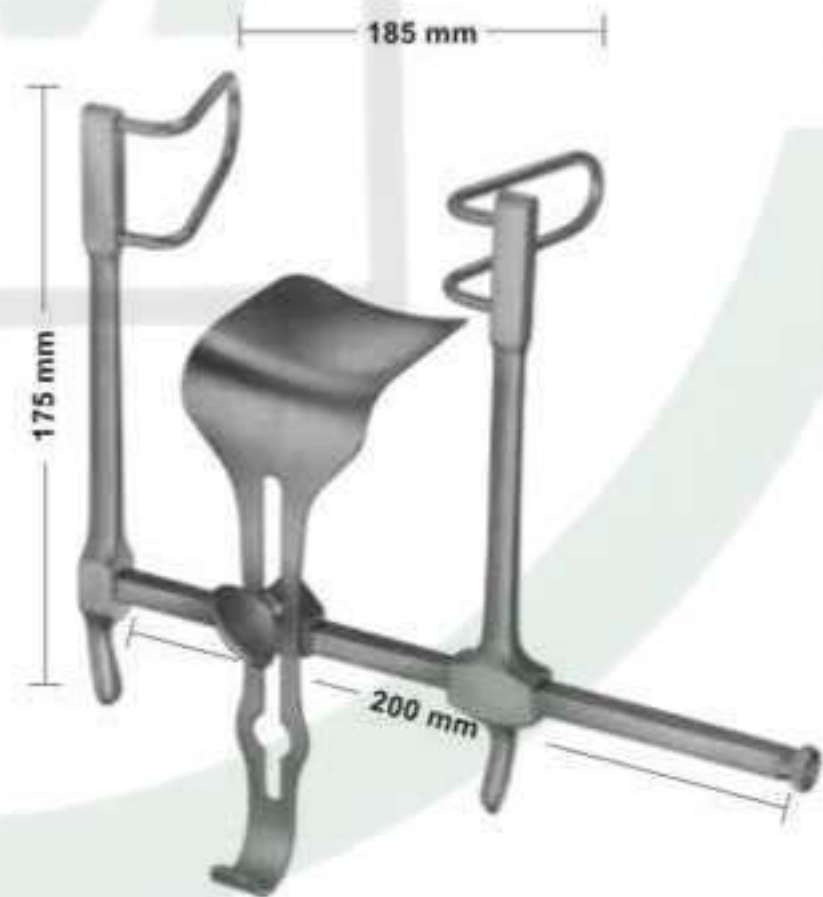

06-259
GOSSET
Lateral blades 58 mm deep
Center blade 59 x 57 mm



Abdominal Retractors

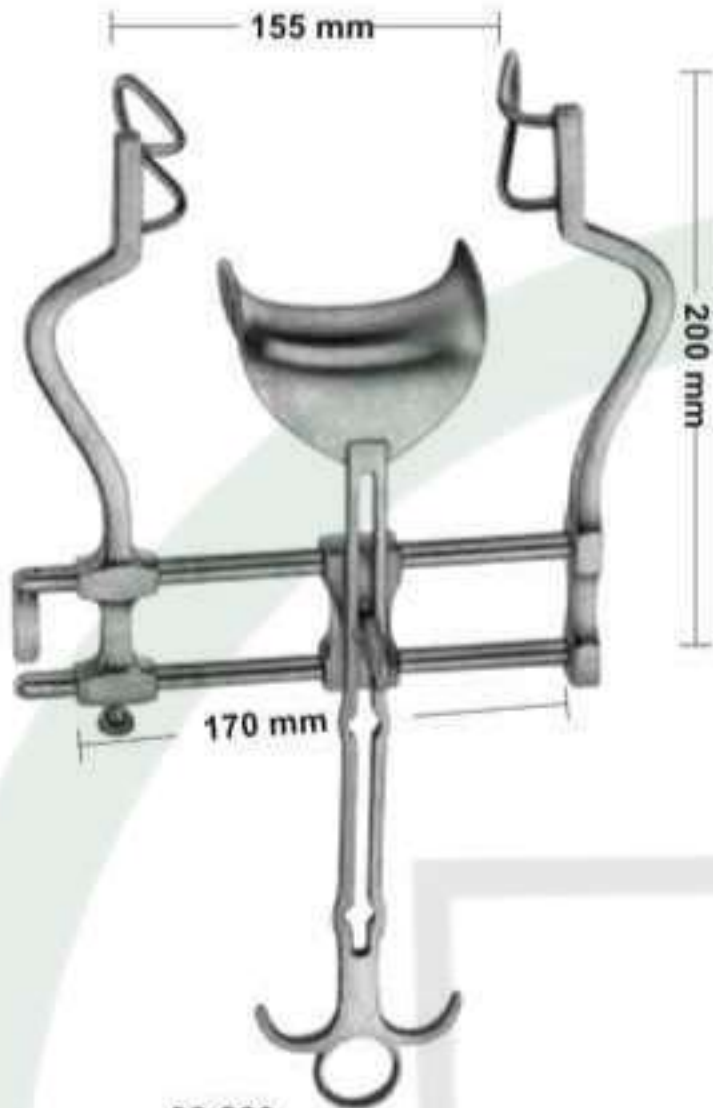

06-260
BALFOUR
Lateral blades 60 mm deep
Center blade 47 x 80 mm

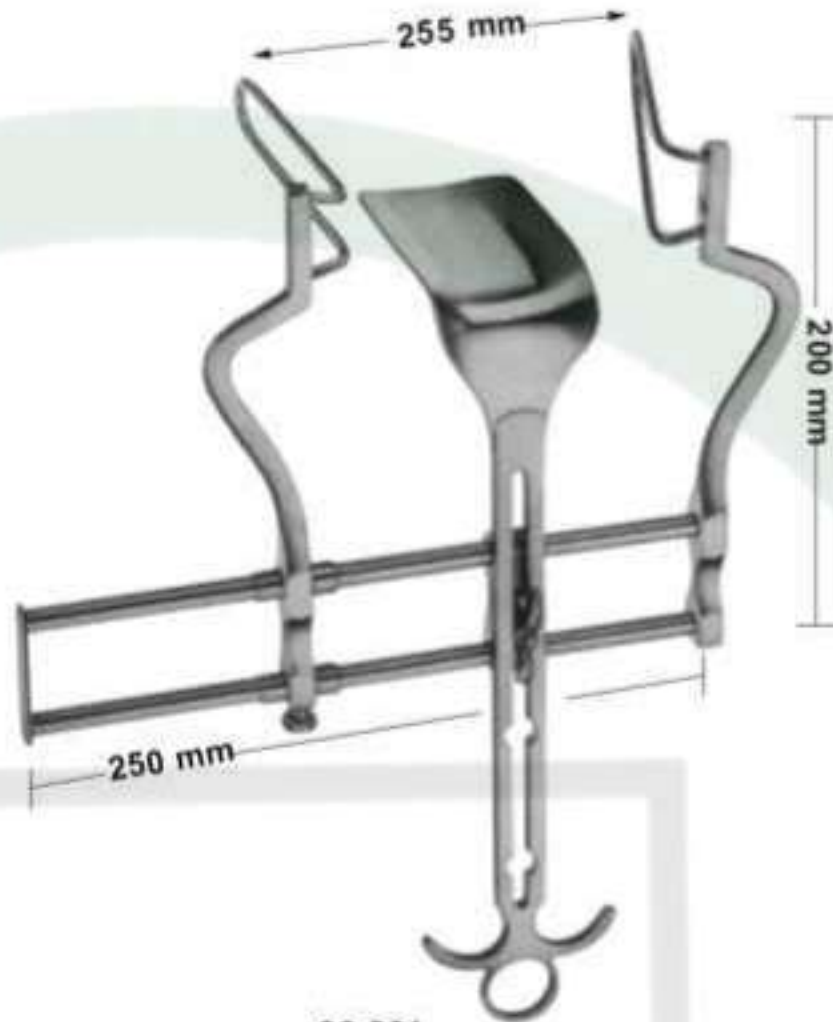

06-261
BALFOUR
Lateral blades 105 mm deep
Center blade 107x 59 mm



06-262
Center blade only
54x80 mm

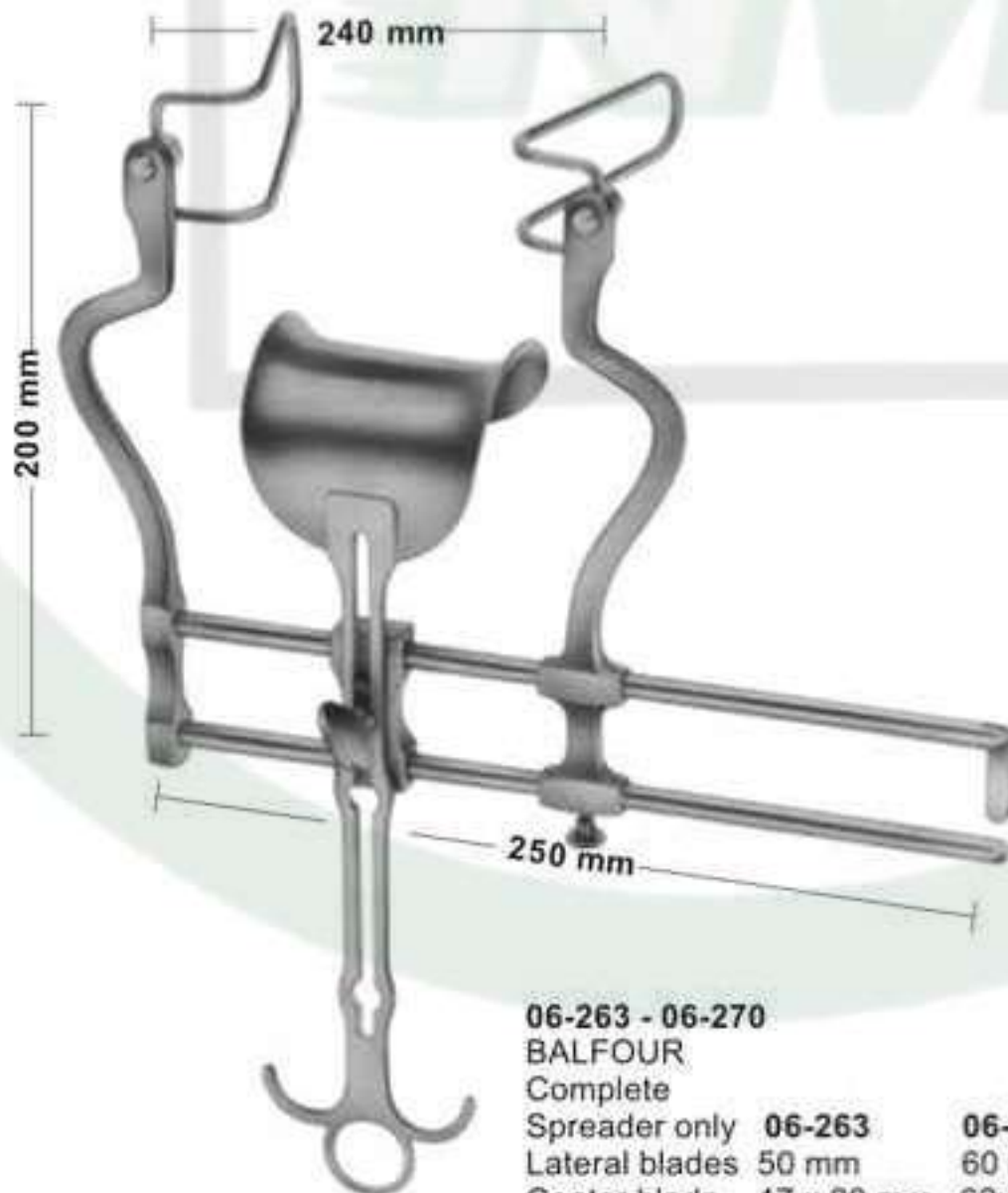

06-263 - 06-270

BALFOUR
Complete

Spreader only

Lateral blades

Center blade

06-263

50 mm

47 x 80 mm

06-264

60 mm

62x76 mm

06-265

75 mm

80x80 mm

06-266

90 mm

80x80 mm



Lateral blades

06-267

50 mm deep

06-268

60 mm deep

06-269

75 mm deep

06-270

90 mm deep

Sales Unit of blades: PR = pair



Organ-, Tissue and Intestinal Grasping Forceps





Intestinal Clamps, soft elastic

ATRAUMATA

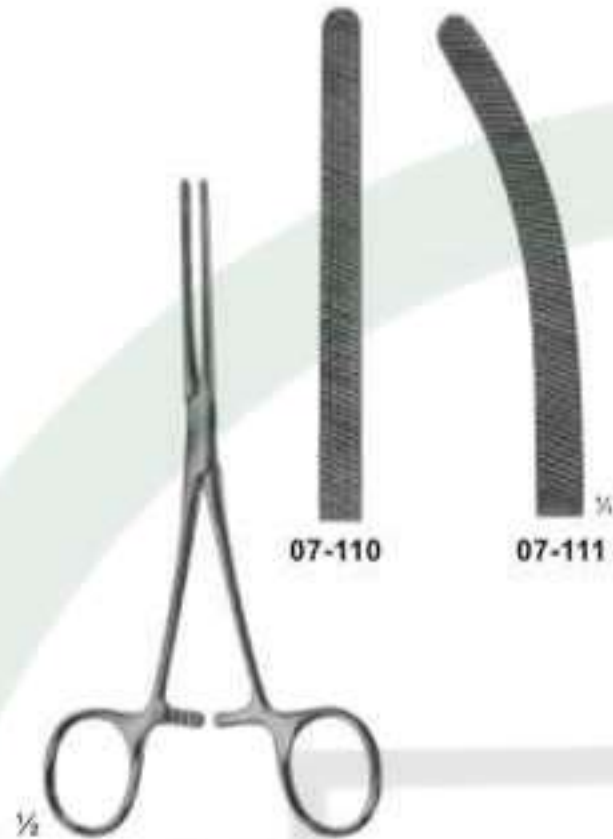

07-110 - 111
DOYEN
elastic
165 mm



07-112 - 113
DOYEN
with elastic blades
170 mm

ATRAUMATA



07-114 - 115
HARTMANN
with elastic blades
200 mm



07-116 - 117
HARTMANN
with elastic blades
200 mm



Intestinal and Pylorus Clamps



½

07-118
PAYR
Intestinal clamp
light pattern,
for children
180 mm

½

07-119
PAYR
200 mm

½

07-120
PAYR
275 mm

½

07-121
PAYR
Pylorus clamp
315 mm



ATRAUMATA

Sigmoid Anastomosis Forceps

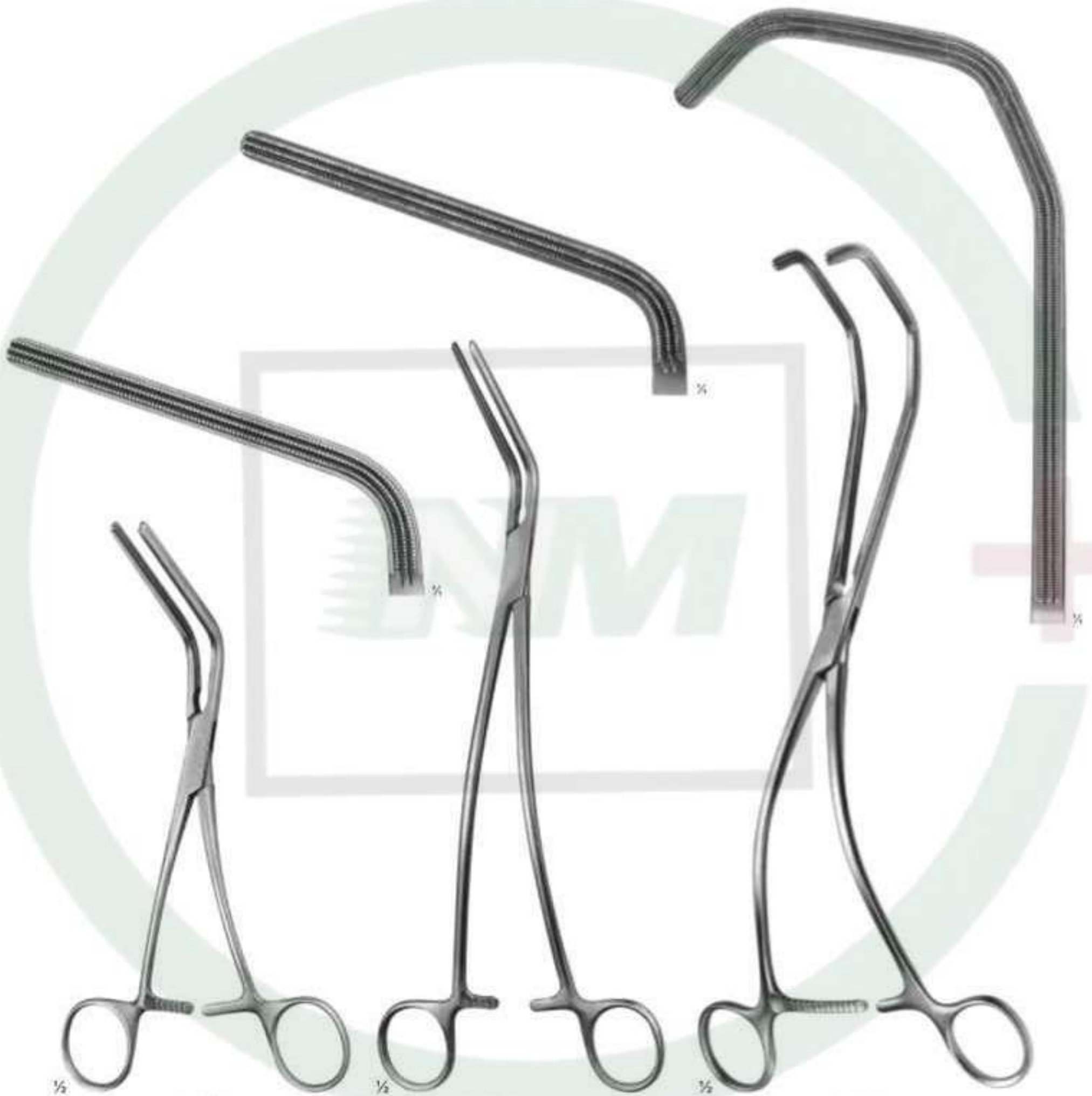

07-122
MORRIS
175 mm

07-123
DE BAKEY
(MORRIS modif.)
240 mm

07-124
KERSTING
270 mm



Nasal Specula



08-101
Martin
13 cm / 5 1/8"



08-102
SIMS
160 mm



08-103
Tieck-Halle
13 cm / 5 1/8"



08-104
Killian

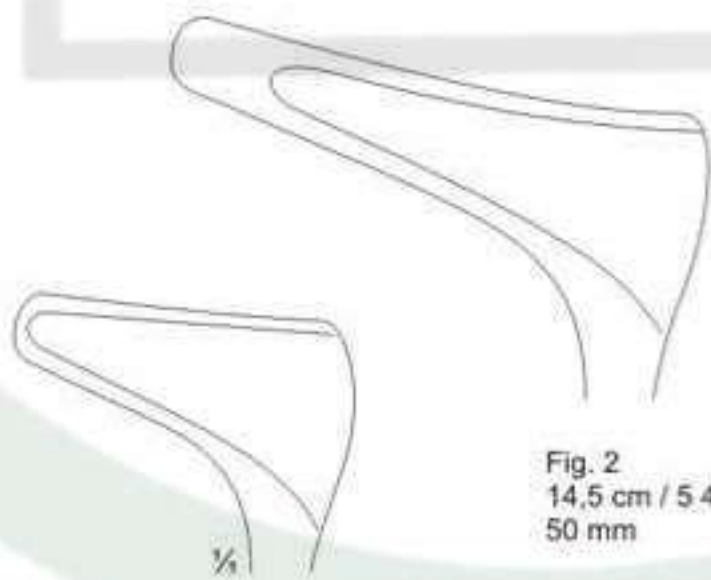
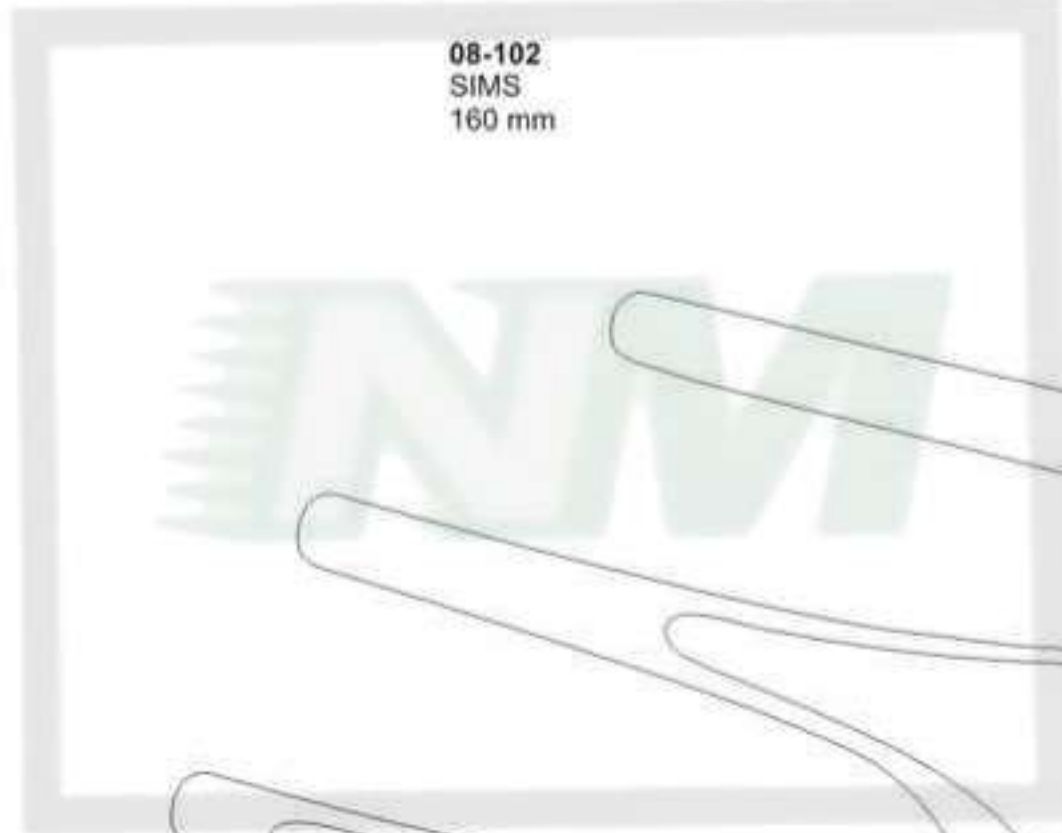

Fig. 1
14 cm 5 4/8"
35 mm

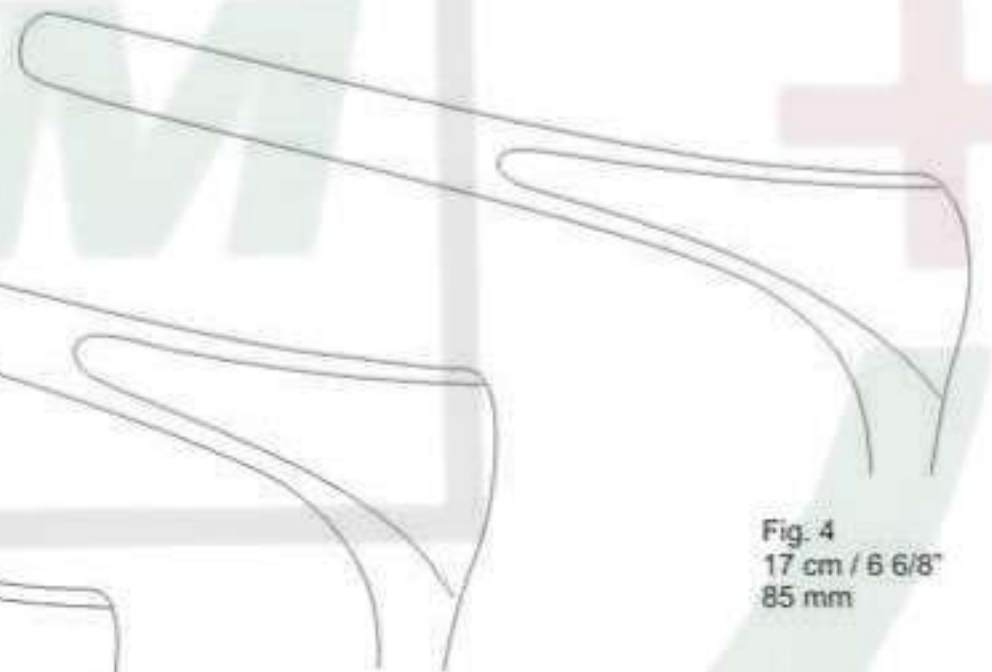

Fig. 4
17 cm / 6 6/8"
85 mm

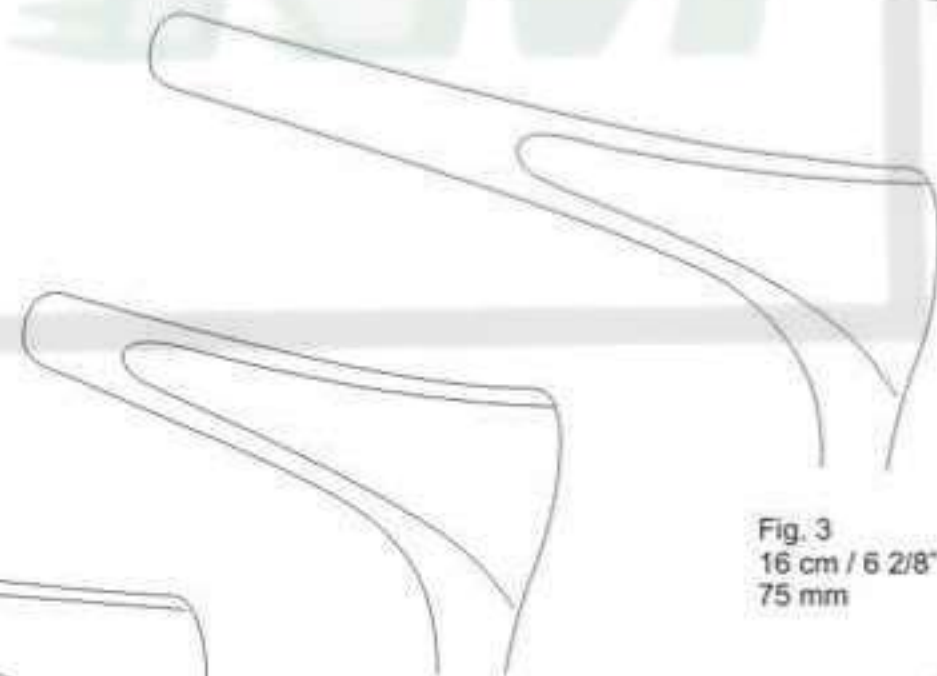

Fig. 3
16 cm / 6 2/8"
75 mm

Fig. 2
14,5 cm / 5 4/8"
50 mm

Nasal Specula



08-105
Cottle

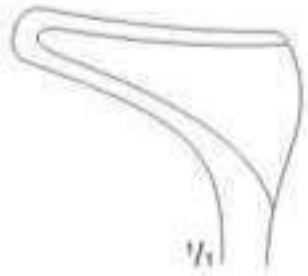

Fig. 1
13,5 cm / 5 3/8"
35 mm

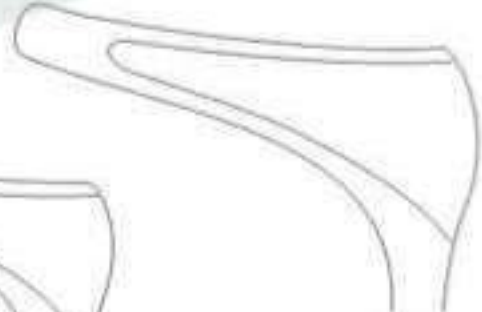

Fig. 2
14 cm / 5 4/8"
50 mm

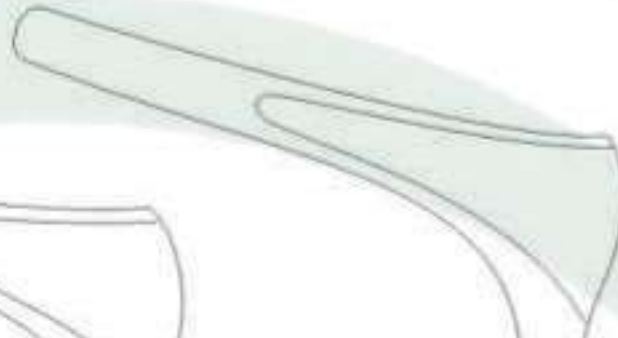

Fig. 3
16 cm / 6 2/8"
75 mm

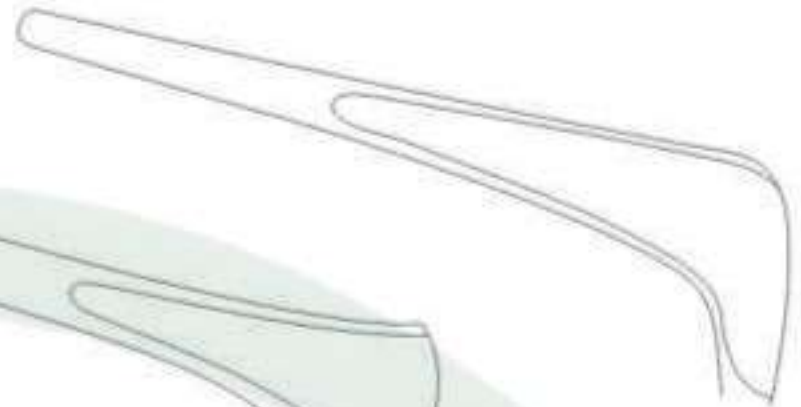

Fig. 4
16 cm / 6 2/8"
85 mm



08-106
Goldsmith (Thudichum)
6,5 cm / 2 4/8"



Fig. 1
21,0 x 9,5 mm



Fig. 2
21,0 x 10,5 mm



Fig. 3
21,0 x 11,5 mm



08-107
Mod. Wien 2
13,5 cm / 5 1/8"



30 mm



08-108
Hartmann-Halle
16 cm / 6 3/8"



Fig. 1
27 mm



Fig. 2
31 mm



Fig. 3
35 mm



Anusscopes-Sphincteroscopes



08-109
IVES-FANSLER
Anuscope
145 mm
Ø24mm



08-110
KELLY
Sphincteroscope
160 mm
Ø21mm



08-111
KELLY
Sphincteroscope
160 mm
Ø27mm

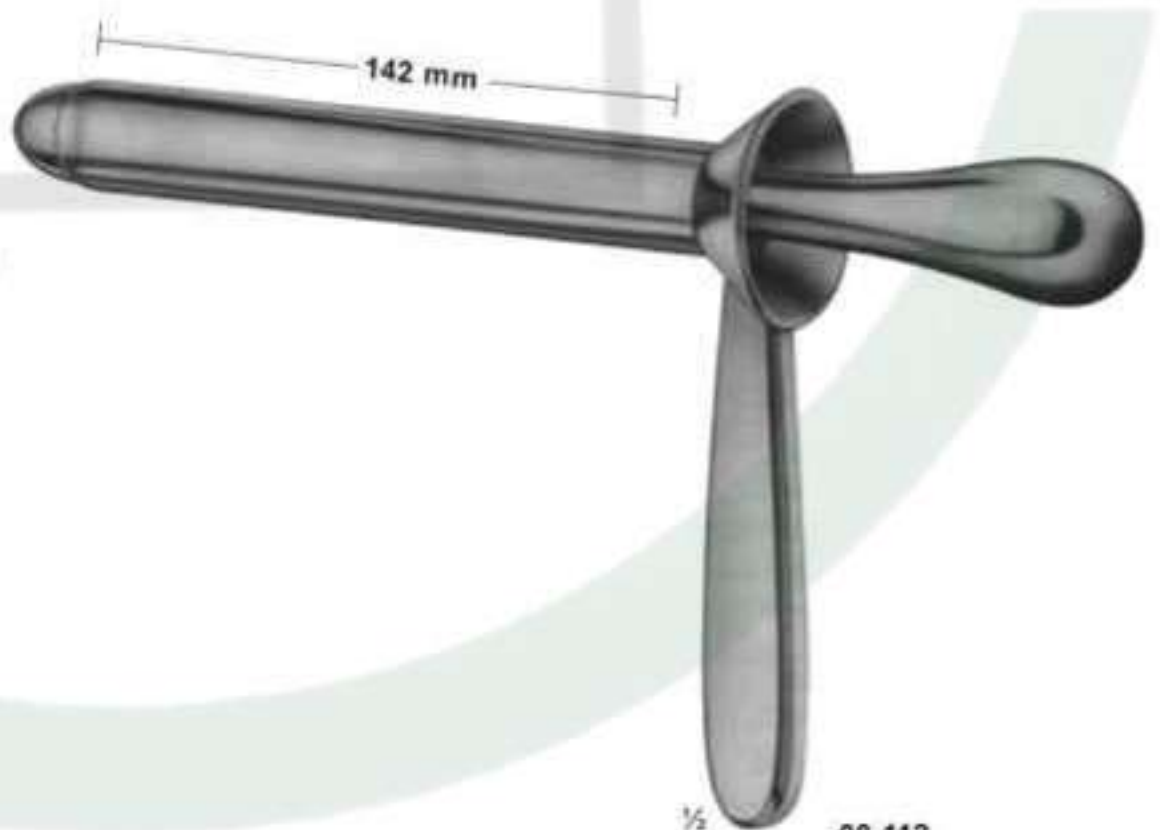

08-112
KELLY
Proctoscope
140 mm
Ø22mm



Haemorrhoidal Forceps

ATRAUMATA





Gall Duct Forceps



08-118
LOWER
180 mm



08-119
LAHEY (SWEET)
190 mm



08-120
LAHEY
220 mm



08-121
DESJARDINS
Gall duct-and cystic forceps
210 mm



08-122
NISSEN
Gall duct-and cystic forceps
215 mm



Gall Duct Dilators and Gall Stone Scoops

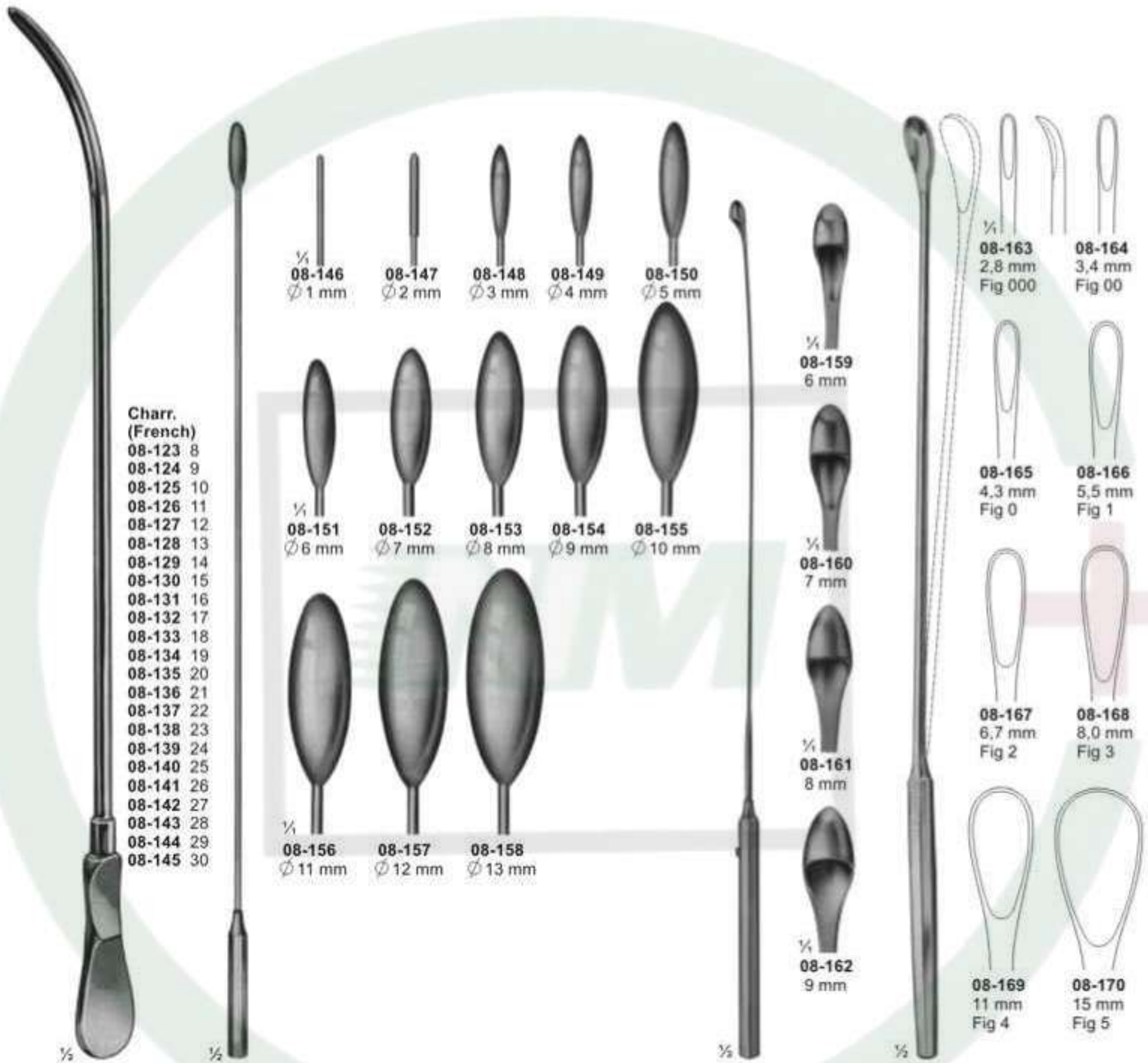

**Charr.
(French)**
 08-123 8
 08-124 9
 08-125 10
 08-126 11
 08-127 12
 08-128 13
 08-129 14
 08-130 15
 08-131 16
 08-132 17
 08-133 18
 08-134 19
 08-135 20
 08-136 21
 08-137 22
 08-138 23
 08-139 24
 08-140 25
 08-141 26
 08-142 27
 08-143 28
 08-144 29
 08-145 30

1/4
 08-146
 Ø 1 mm

08-147
 Ø 2 mm

08-148
 Ø 3 mm

08-149
 Ø 4 mm

08-150
 Ø 5 mm

1/4
 08-151
 Ø 6 mm

08-152
 Ø 7 mm

08-153
 Ø 8 mm

08-154
 Ø 9 mm

08-155
 Ø 10 mm

1/4
 08-156
 Ø 11 mm

08-157
 Ø 12 mm

08-158
 Ø 13 mm

1/4
 08-159
 6 mm

1/4
 08-160
 7 mm

1/4
 08-161
 8 mm

1/4
 08-162
 9 mm

1/4
 08-163
 2.8 mm
 Fig 000

08-164
 3.4 mm
 Fig 00

08-165
 4.3 mm
 Fig 0

08-166
 5.5 mm
 Fig 1

08-167
 6.7 mm
 Fig 2

08-168
 8.0 mm
 Fig 3

08-169
 11 mm
 Fig 4

08-170
 15 mm
 Fig 5

08-123 - 08-145
DITTEL
 Metall bougies and
 dilating sounds, stiff
 345 mm

08-146 - 08-158
BAKES
 Common bile duct
 dilators, malleable
08-146 - 08-150 315 mm
08-151 - 08-158 320 mm

08-159 - 08-162
DESJARDINS
 Probe and catch
 with flexible shaft
 300 mm

08-163 - 08-170
LUER-KOERTE modif
 with malleable shaft
 310 mm



Gall Stone Forceps

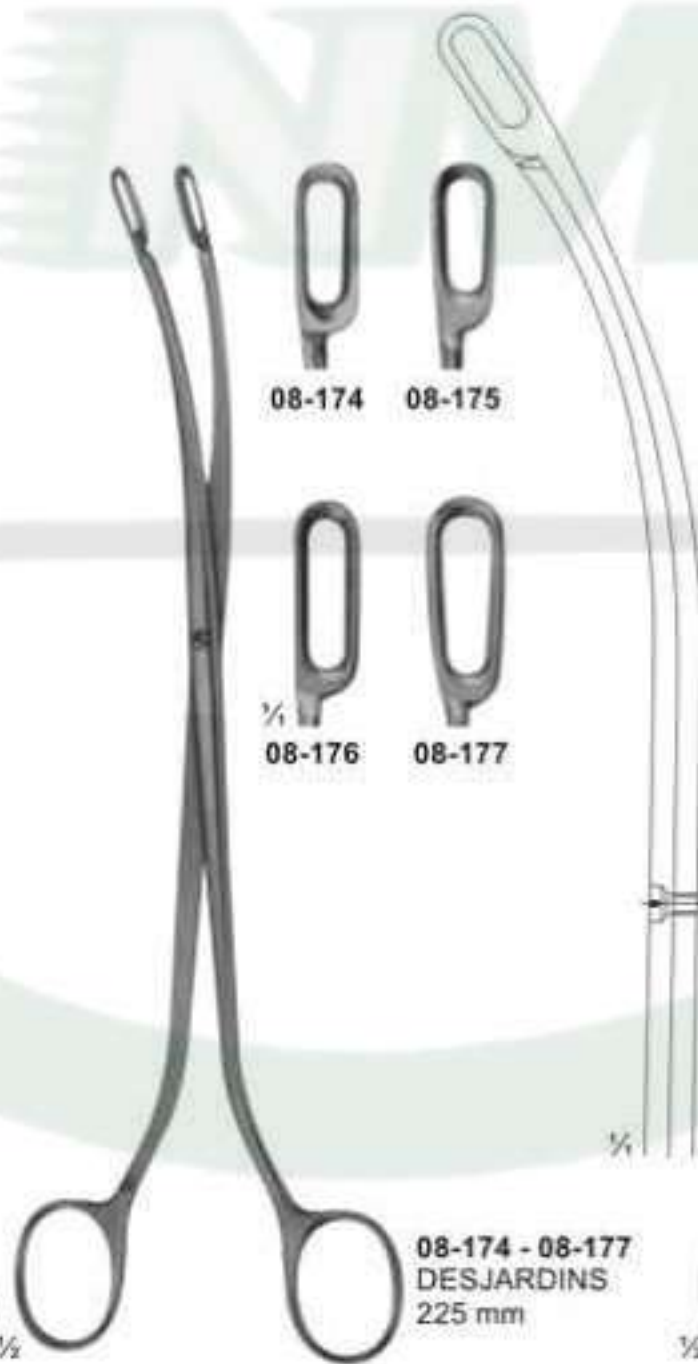
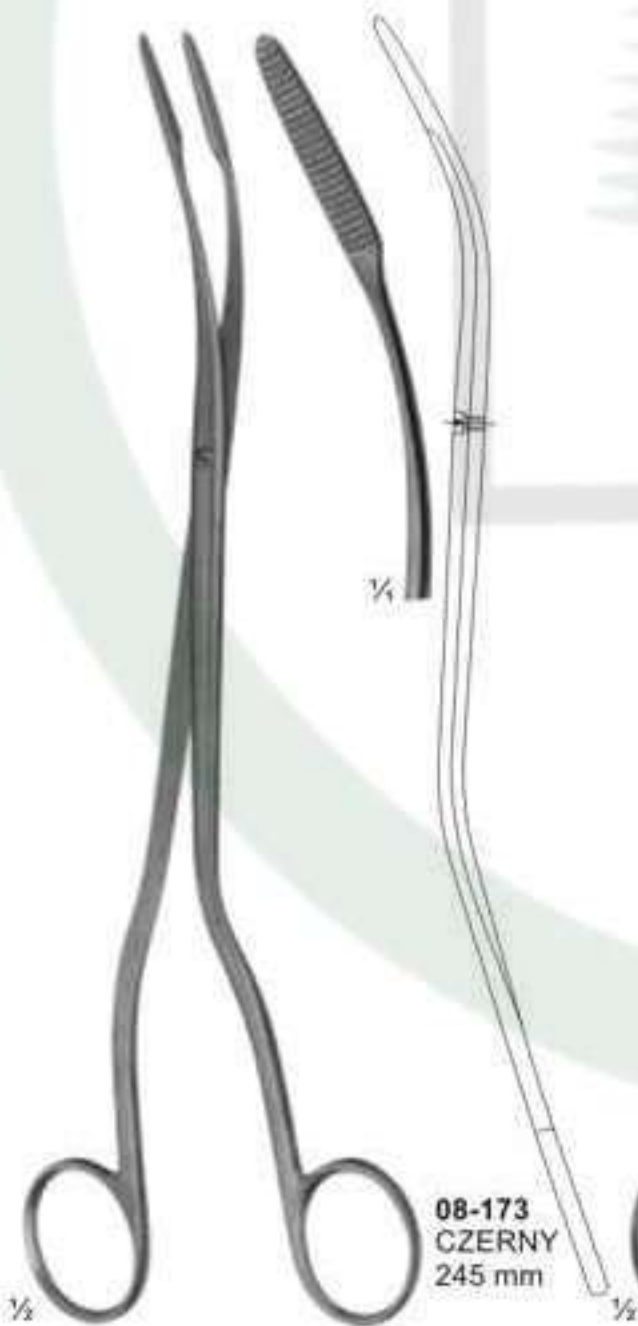



Kidney Clamps

ATRAUMATA

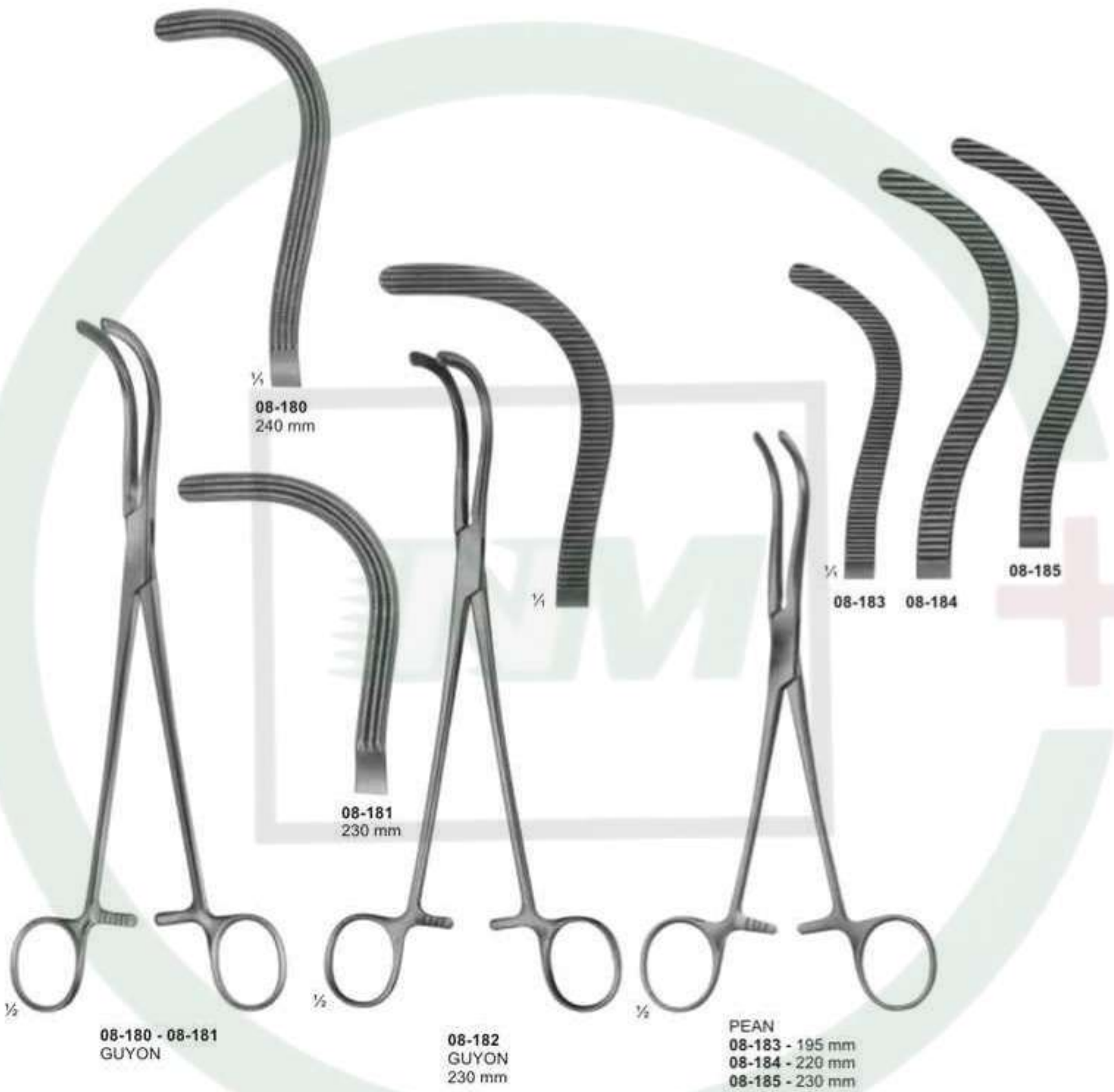



Kidney Stone Forceps



08-186 - 08-189
RANDALL
225 mm

08-190 - 08-192
RANDALL
190 mm



Bladder Retractors

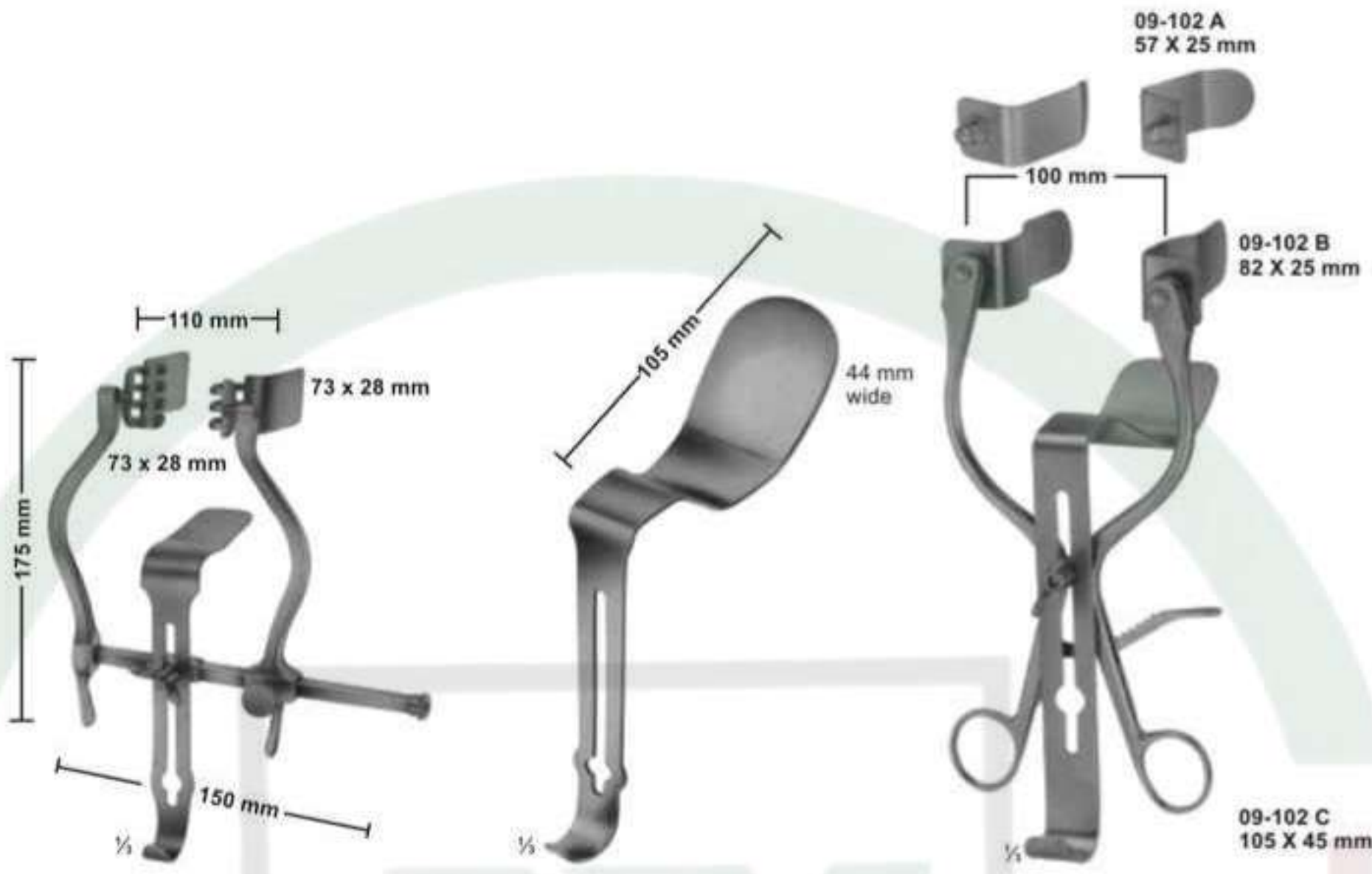

09-101
JUDD-MASSON
Bladder-and suprapubic
retractor

09-102
MILLIN
Center blade for
retro pubic prostatectomy

09-103
MILLIN
Bladder retractor, complete
105X45 mm



09-104
LEGUEU
Bladder retractor
Center blade
80 x 31 mm



09-105
KOCHER
Bladder spatula
235 mm

Trocars

Luer Lock

09-106
KLIMA ROSEGGER
35 X 1,8 mm
Sternal puncture needle

09-107
Universal trocar
with 4 tips

ϕ 6,0 mm
 ϕ 4,5 mm
 ϕ 3,3 mm
 ϕ 1,9 mm

NELSON

09-108 - 112
Inside diam. Outside diam
09-108 2,2 mm 3,0 mm
09-109 3,0 mm 4,0 mm
09-110 4,0 mm 5,0 mm
09-111 5,0 mm 6,0 mm
09-112 5,5 mm 6,5 mm
for hydrocele and abdominal puncture

09-113 - 116
Inside diam. Outside diam
09-113 2,2 mm 3,0 mm
09-114 3,0 mm 4,0 mm
09-115 4,0 mm 5,0 mm
09-116 5,0 mm 6,0 mm
for abdominal puncture,
with stop-cock and lateral
drain

09-117 - 118
Inside diam. Outside diam
09-117 6,5 mm 8,0 mm
09-118 9,0 mm 10,0 mm
Empyema trocar
BUELEU

09-119 - 122
Inside diam. Outside diam
09-119 3,0 mm 4,0 mm
09-120 3,6 mm 4,6 mm
09-121 4,3 mm 5,3 mm
09-122 5,0 mm 6,0 mm
Gall bladder trocars. OCHSNER

09-123
PIERCE
Antrum trocar
 ϕ 4,0 mm

09-124
COAKLEY
Antrum trocar
3,0 mm

Record Cone1

Luer - Lock Cone

100 mm
110 mm

80 mm

100 mm

Vaginal Specula



10-101
COLLIN
for children
53 x 10 mm

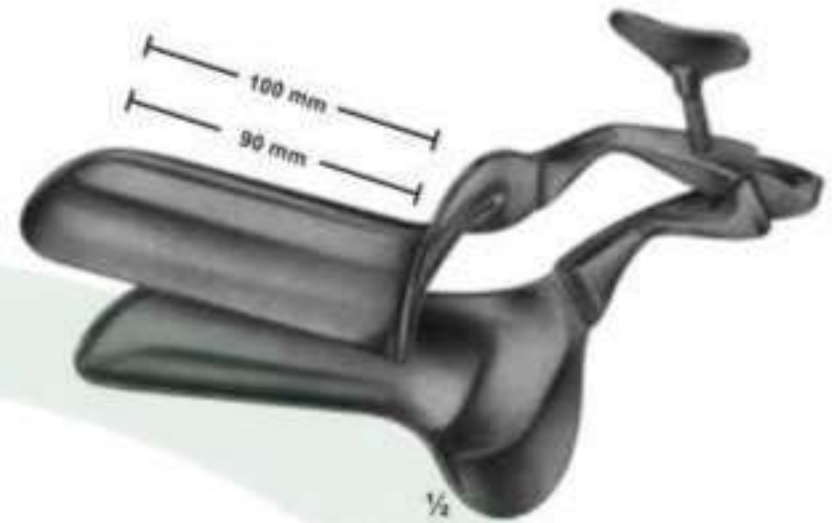

10-102 - 105
COLLIN

10-102	100/90mm	28 mm
10-103	100/90mm	32 mm
10-104	105/95mm	35 mm
10-105	115/105mm	40 mm
Total length/working length		width



10-106
COLLIN
for virgins
95/85 x 18 mm



10-107
CUSCO
for virgins
75 x 17 mm



10-108
CUSCO
for virgins
75 x 17 mm



Swiss patterns
features: long and narrow

10-109 - 111
CUSCO

10-109	92x23-25 mm
10-110	100x25-27 mm
10-111	110x27-30 mm



Vaginal Specula- Sets, upper and lower blades



10-112 - 114
GRAVE
10-112 75X20 mm
10-113 95X30 mm
10-114 105X33 mm

1/4

10-115 - 116
PEDERSON
10-115 100X22 mm
10-116 120X25 mm

1/2

10-117 - 118
BRIESKY
10-117 72X25 mm / 77X30 mm 140 mm
10-118 75X30 mm / 92X38 mm 170 mm

1/2



1/2

10-119
SIMS
70 X 26 mm / 75 X 30 mm
75 X 30 mm / 80 X 35 mm
80 X 36 mm / 90 X 40 mm
175 mm



1/2

10-120 - 122
SEIDL
10-120 80X8 mm
10-121 80X10 mm
10-122 90X14 mm
For children and infants
170 mm



1/2

10-123
KRISTELLER
70X15 mm, (170 mm)
For children



1/2

10-124 - 10-126
KRISTELLER
10-124 70X27 mm
10-125 75X30 mm
10-126 90X36 mm



Vaginal Specula- upper and lower blades



10-127 - 131
KRISTELLER
10-127 110X18 mm
10-128 110X20 mm
10-129 110X27 mm
10-130 110X30 mm
10-131 110X36 mm
220 mm

10-132 - 10-135
KRISTELLER
Upper blades

10-136 - 10-139
KRISTELLER
Lower blades



Vaginal Specula



10-140 - 142
DOYEN
235 mm

length of blades
60 mm
90 mm
120 mm
160 mm

width of blades
35 mm 45 mm 60 mm

width of blades
35 mm 45 mm 60 mm
10-143 10-146 10-150
10-144 10-147 10-151
10-145 10-148 10-152
 10-149 10-153

10-143 - 10-153
DOYEN
240 mm



Vaginal Retractors



1/2
10-154
JOLL (FRIEDMAN)
155 mm



1/2
10-155
RICHTER
170 mm



1/2
10-156
GELPI
135 mm



1/2
10-157
GELPI
175 mm



Uterine Dilators



11-101 - 143
HEGAR
with very conical point
185 mm

11-101	1	mm	11-123	23	mm
11-102	2	mm	11-124	24	mm
11-103	3	mm	11-125	25	mm
11-104	4	mm	11-126	26	mm
11-105	5	mm	11-127	1	½mm
11-106	6	mm	11-128	2	½mm
11-107	7	mm	11-129	3	½mm
11-108	8	mm	11-130	4	½mm
11-109	9	mm	11-131	5	½mm
11-110	10	mm	11-132	6	½mm
11-111	11	mm	11-133	7	½mm
11-112	12	mm	11-134	8	½mm
11-113	13	mm	11-135	9	½mm
11-114	14	mm	11-136	10	½mm
11-115	15	mm	11-137	11	½mm
11-116	16	mm	11-138	12	½mm
11-117	17	mm	11-139	13	½mm
11-118	18	mm	11-140	14	½mm
11-119	19	mm	11-141	15	½mm
11-120	20	mm	11-142	16	½mm
11-121	21	mm	11-143	17	½mm
11-122	22	mm			



11-144 - 152
HEGAR
205 mm

11-144	1+2	mm
11-145	3+4	mm
11-146	5+6	mm
11-147	7+8	mm
11-148	9+10	mm
11-149	11+12	mm
11-150	13+14	mm
11-151	15+16	mm
11-152	17+18	mm



11-153
HEGAR
Uterine dilator set, in canvas
roll with 8 dilators.



Uterine Probes





Uterine Dressing Forceps



Jaws with longitudinal groove



Polypus-and Ovum Forceps



11-164
HEYWOOD-SMITH
200 mm

11-165
KELLY
320 mm

11-166
HEYWOOD-SMITH
250 mm

11-167
NOTO
280 mm



Ear Currettes

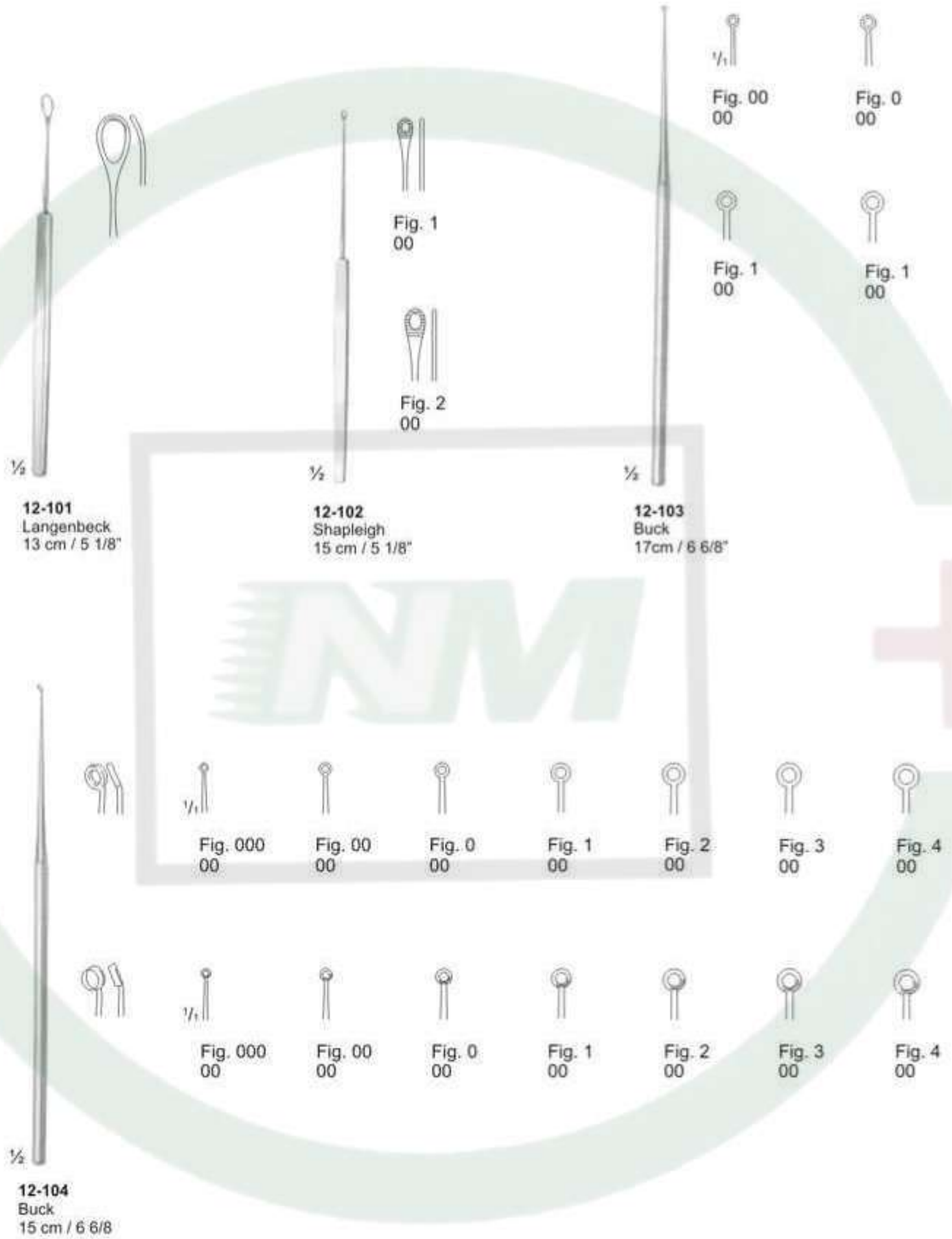



Biopsy Currettes

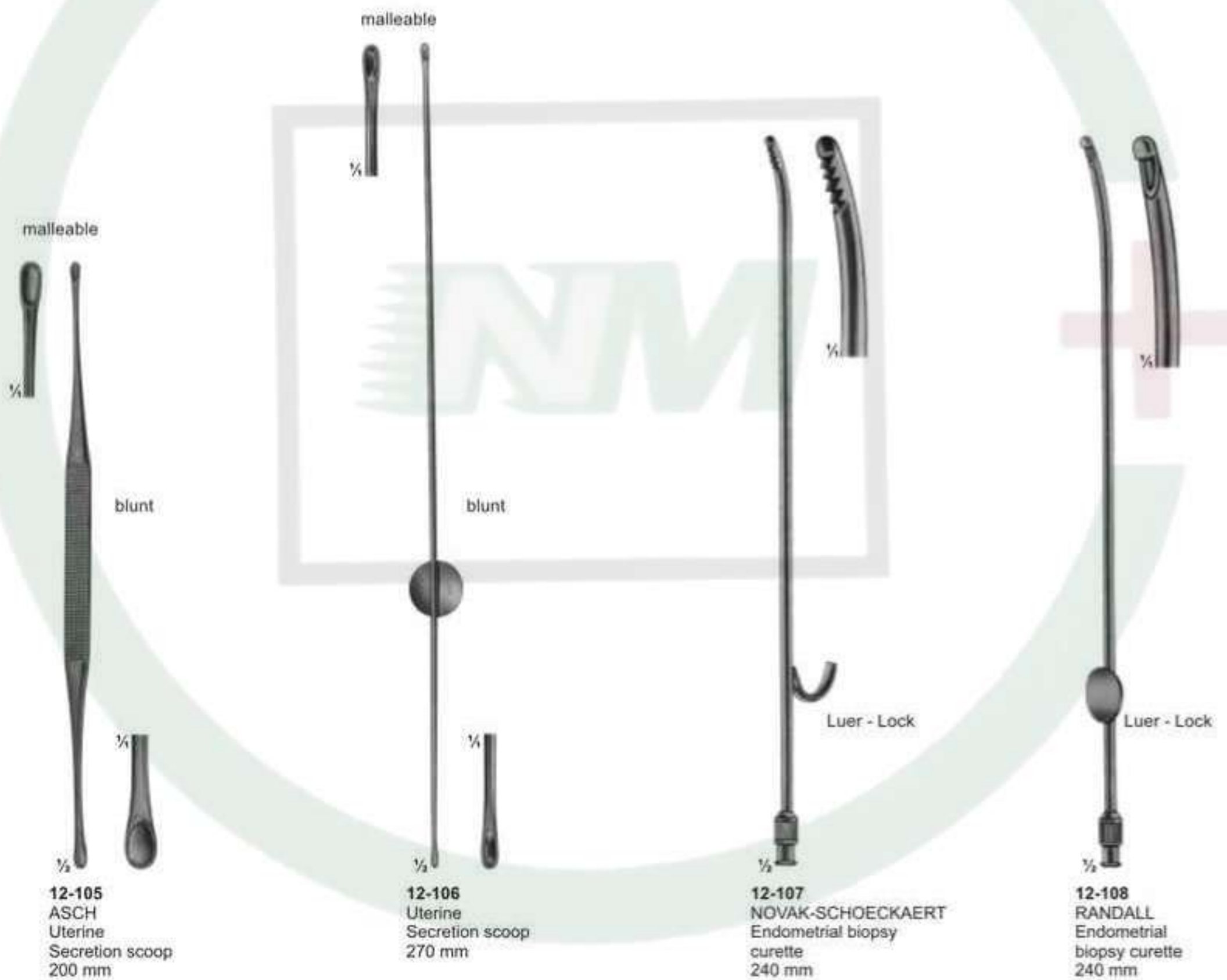



Ear Polypus Forceps

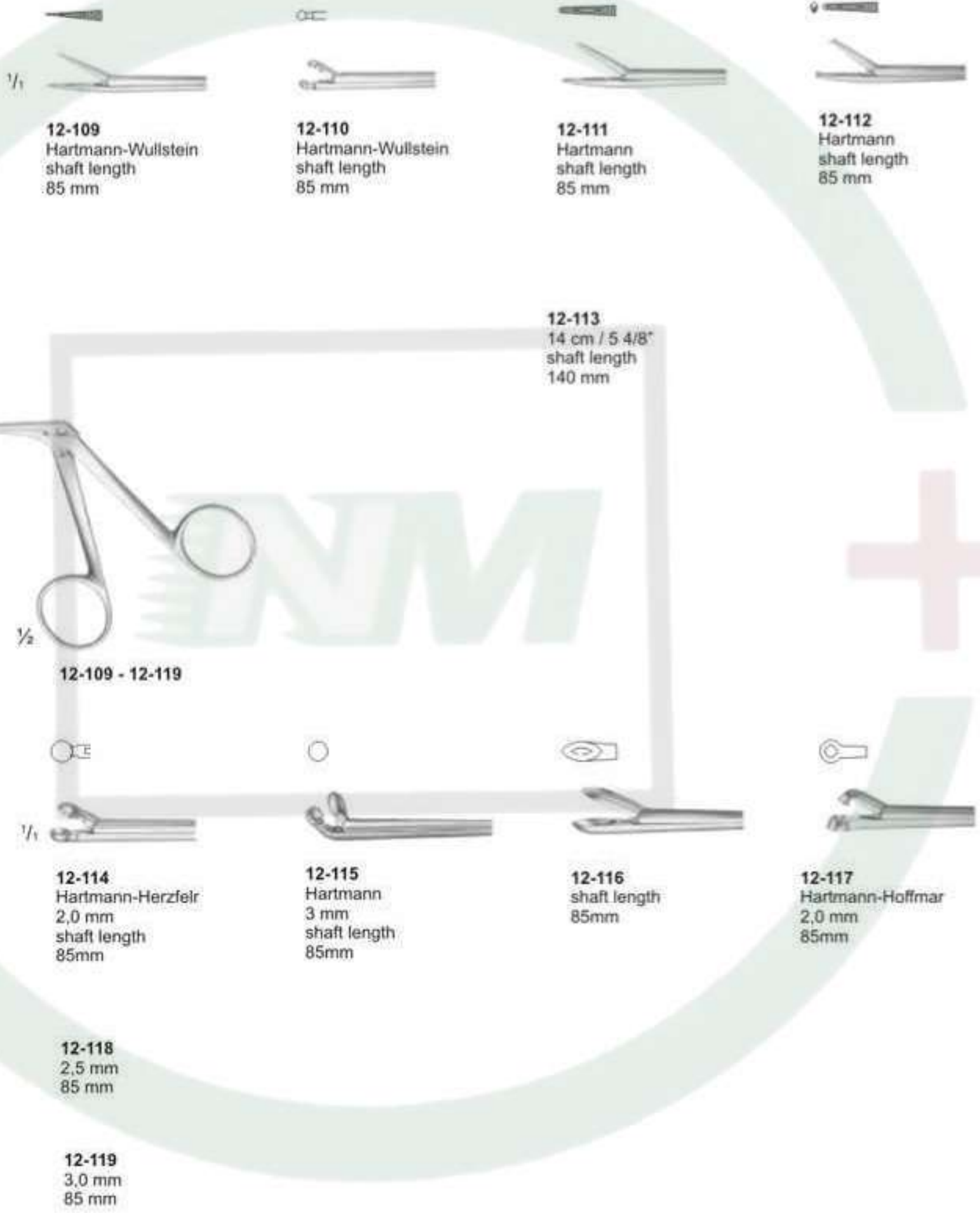

12-109
Hartmann-Wullstein
shaft length
85 mm

12-110
Hartmann-Wullstein
shaft length
85 mm

12-111
Hartmann
shaft length
85 mm

12-112
Hartmann
shaft length
85 mm

12-113
14 cm / 5 4/8"
shaft length
140 mm

12-109 - 12-119

12-114
Hartmann-Herzfeir
2,0 mm
shaft length
85mm

12-115
Hartmann
3 mm
shaft length
85mm

12-116
shaft length
85mm

12-117
Hartmann-Hoffmar
2,0 mm
85mm

12-118
2,5 mm
85 mm

12-119
3,0 mm
85 mm



Biopsy forceps for rectum

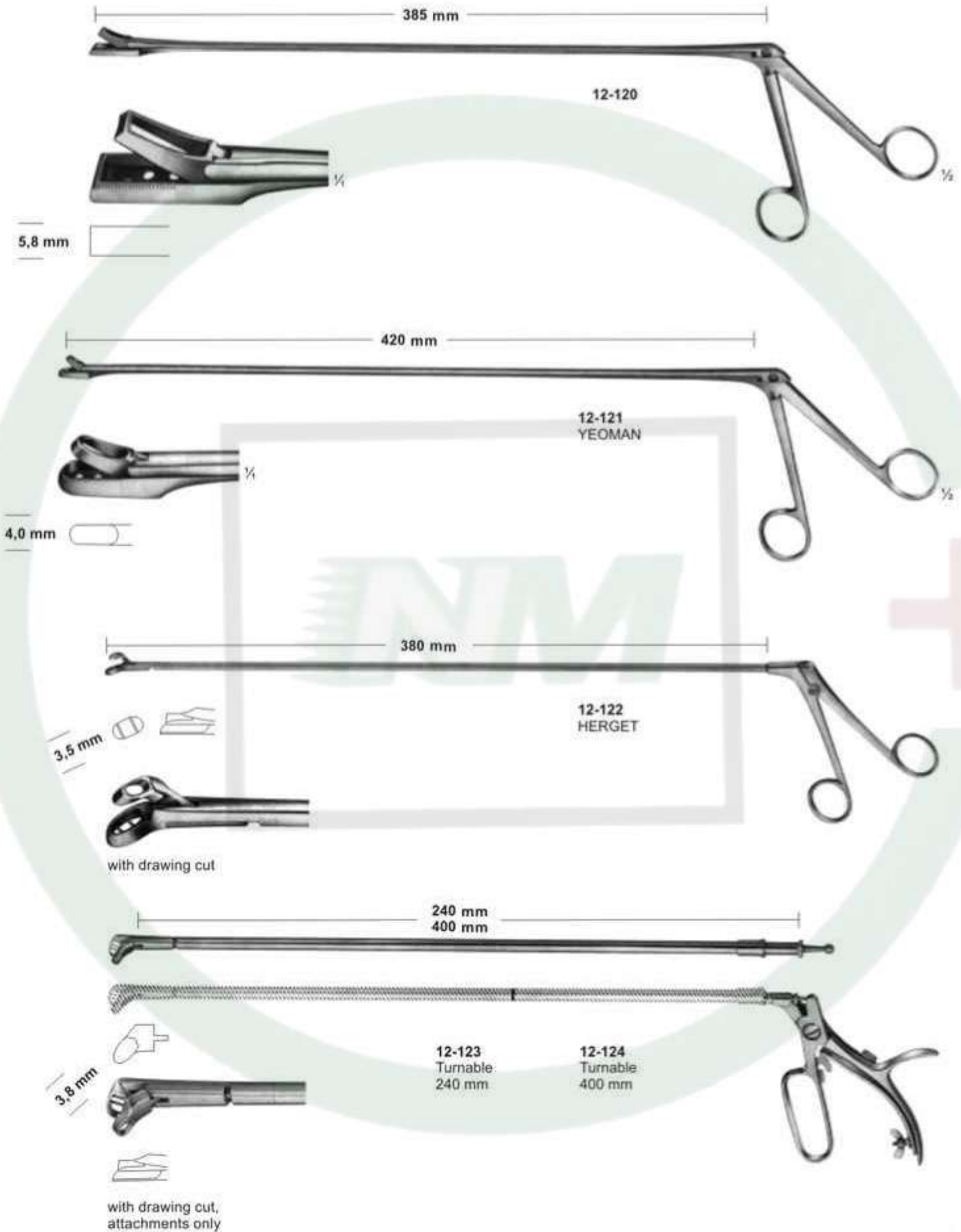



Biopsy Forceps

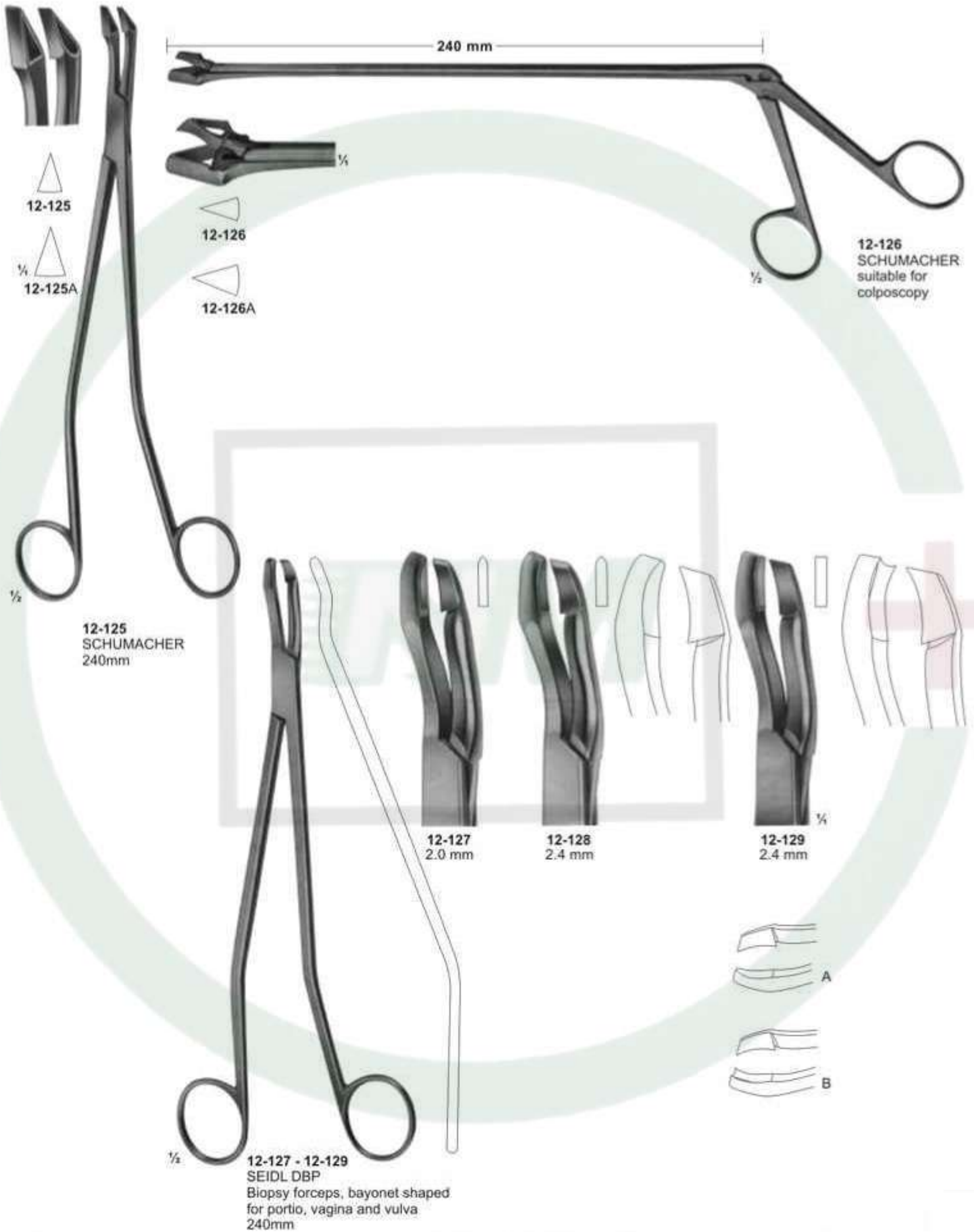



Biopsy Forceps

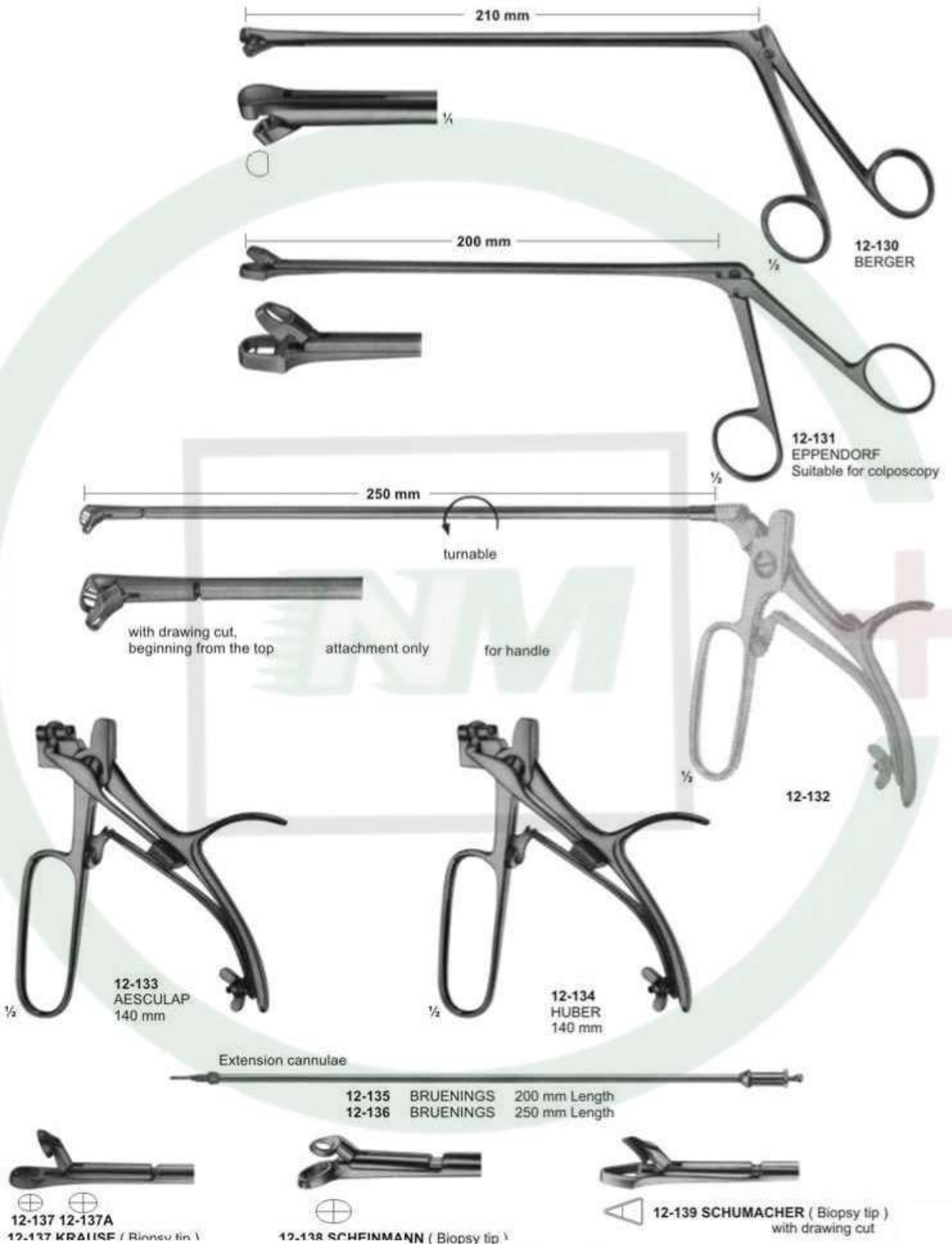



Uterine Scoops

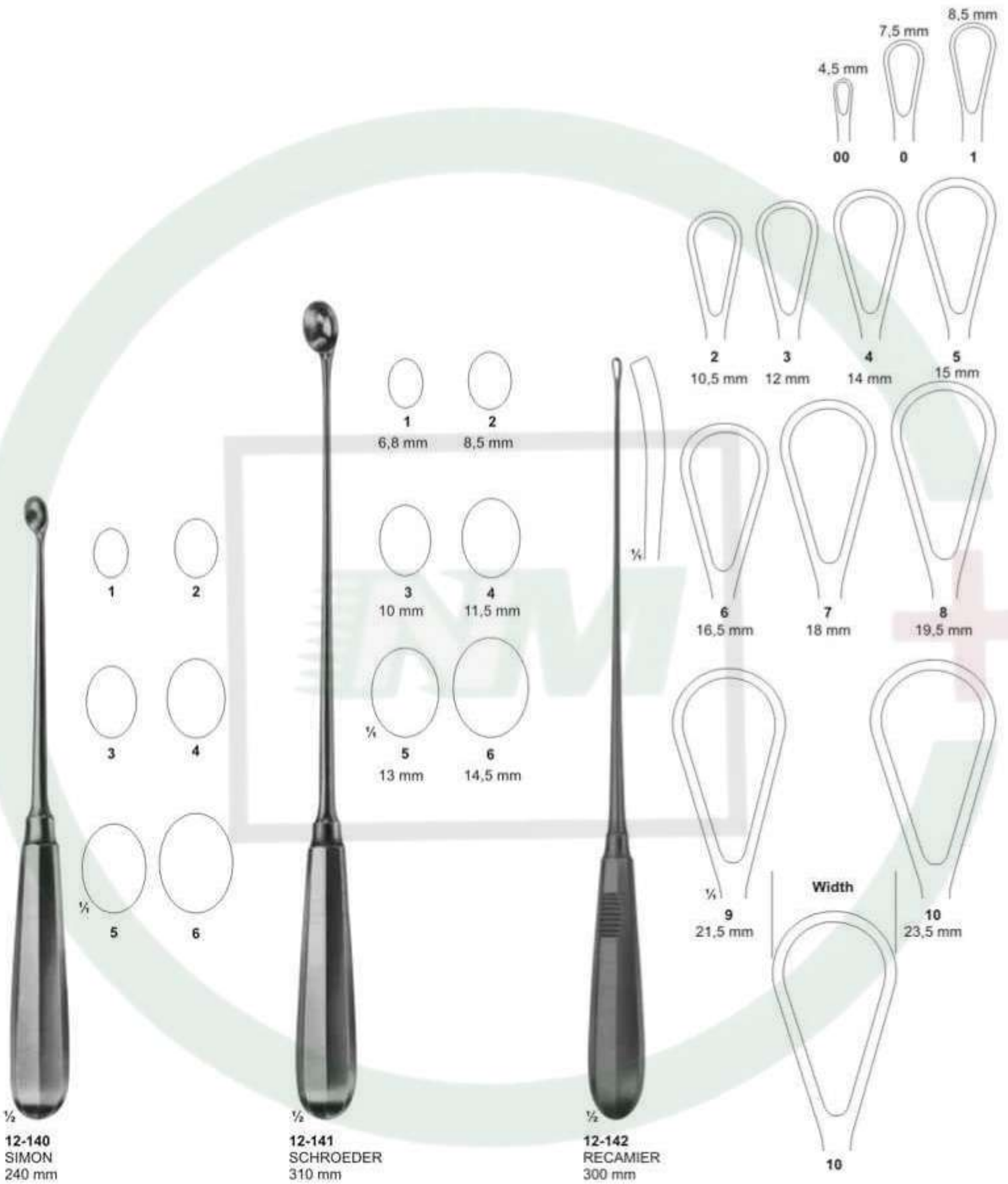



Obstetrical Forceps



1/3

13-101
NAEGELE
355 mm



1/3

13-102
NAEGELE
400 mm



1/3

13-103
SIMPSON-BRAUN
305mm



Obstetrics- Placenta and Ovum Forceps



Fig: 1
13-104

Fig: 2
13-105

Fig: 3
13-106

Fig: 1
13-107

Fig: 2
13-108

Fig: 3
13-109

1/2

13-104 - 106
WINTER
290 mm

1/2

13-107 - 109
WINTER
290 mm

1/2

13-110
SAENGER
275 mm



Tound-and Tracheal Hooks and Dilators

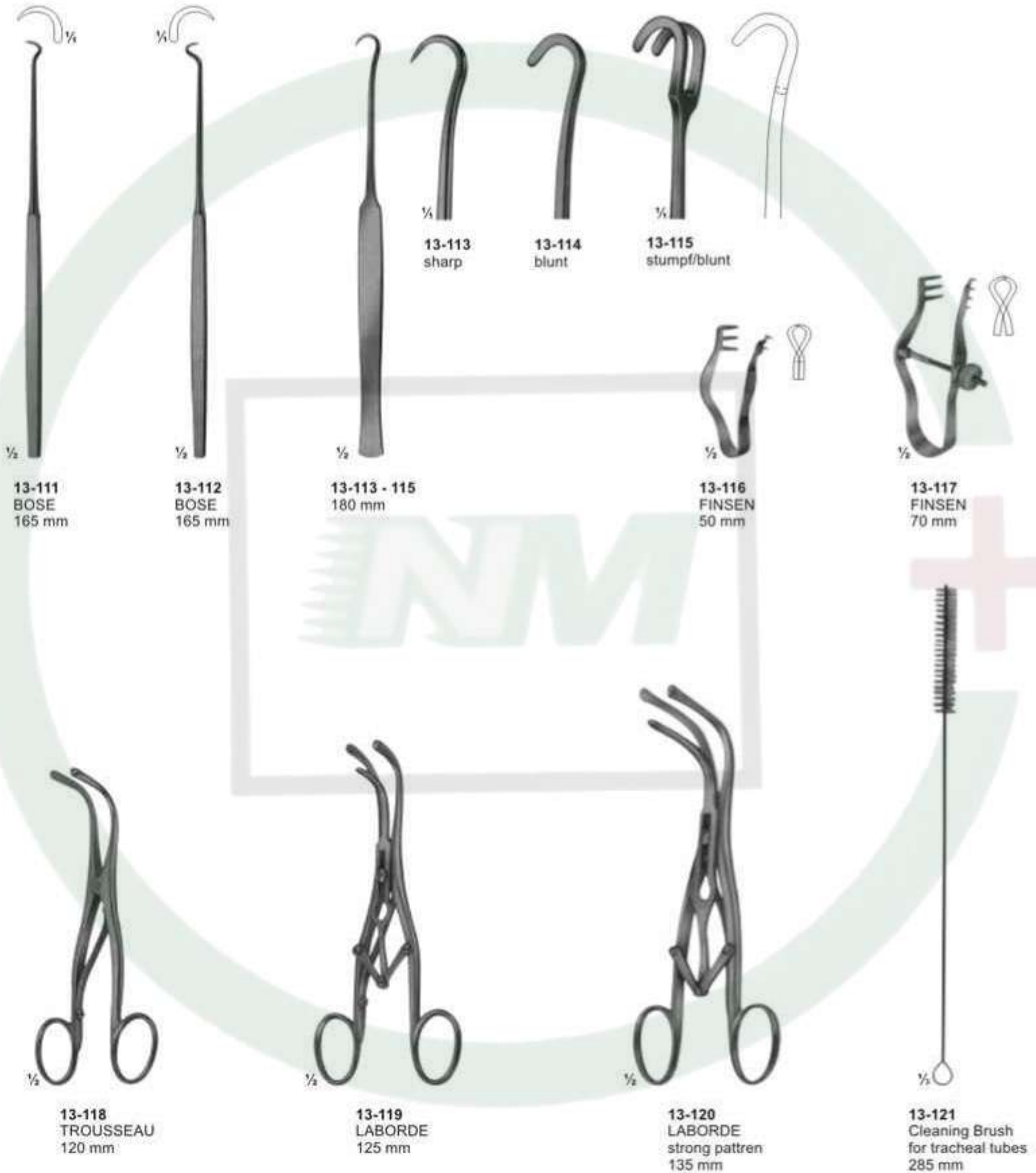



Vascular Spatulas

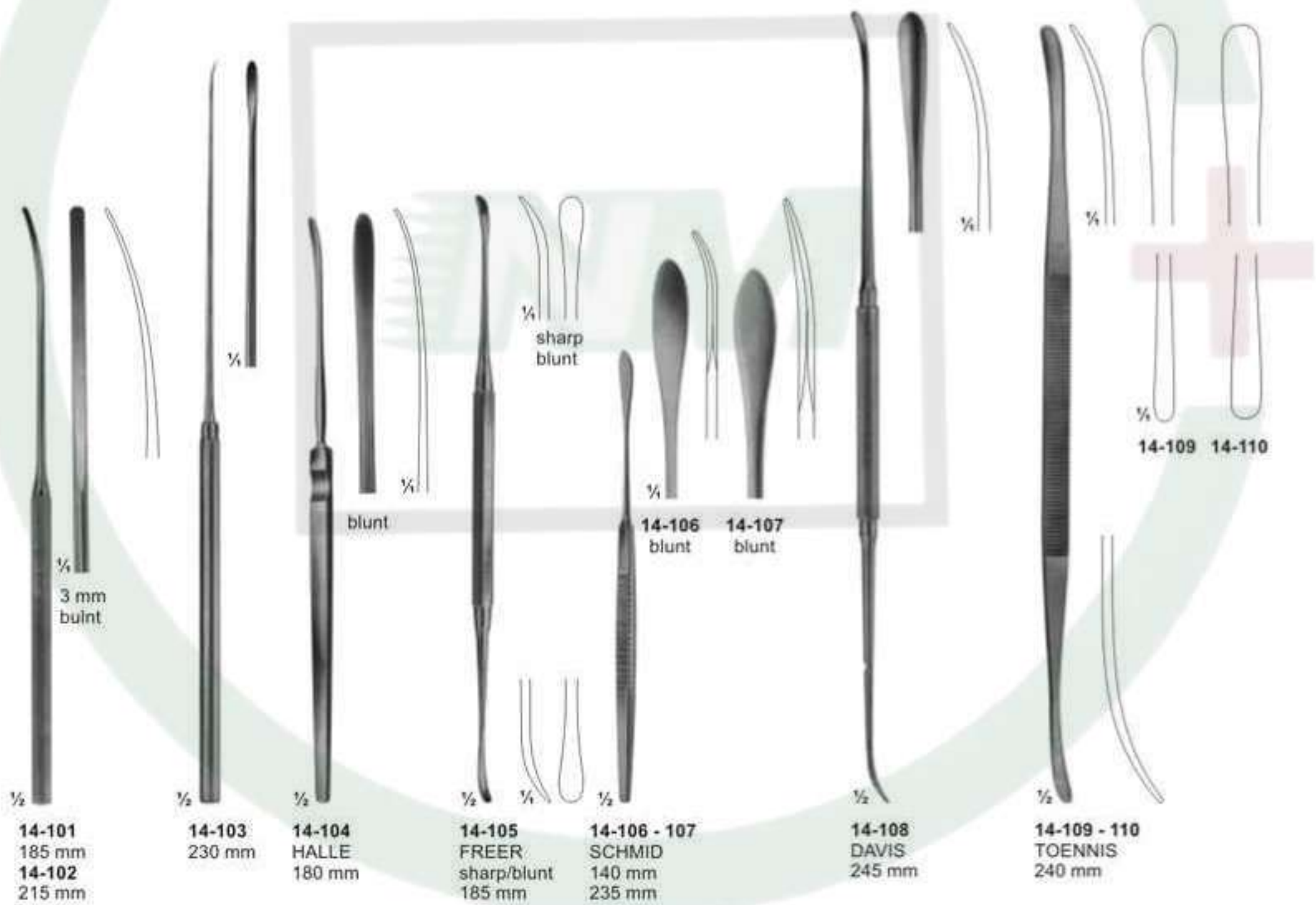



ATRAUMATA Forceps

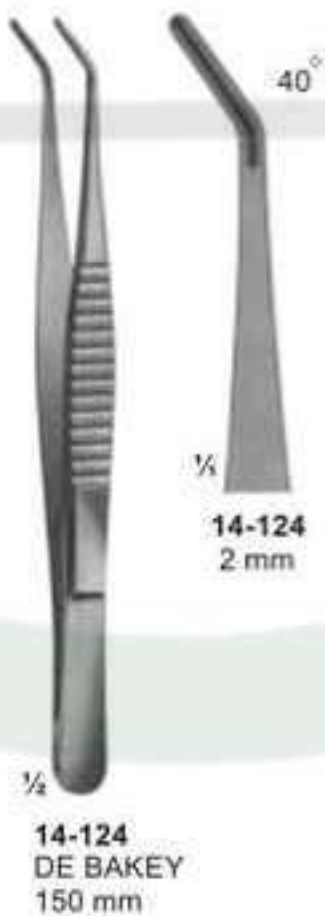
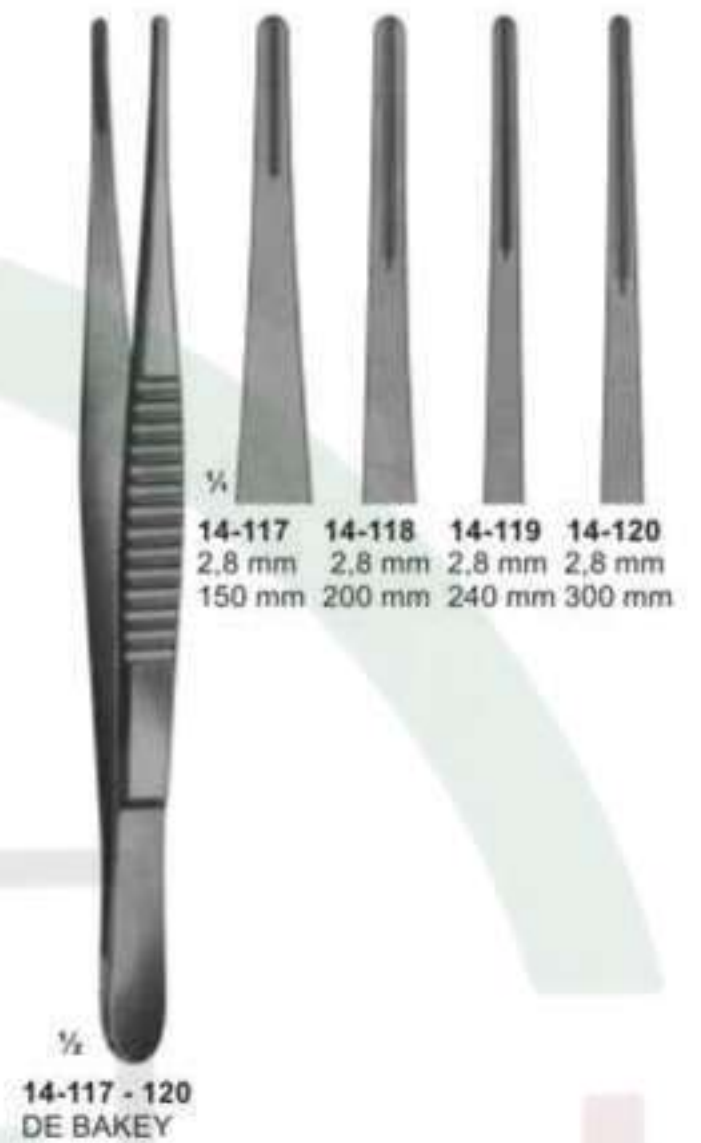
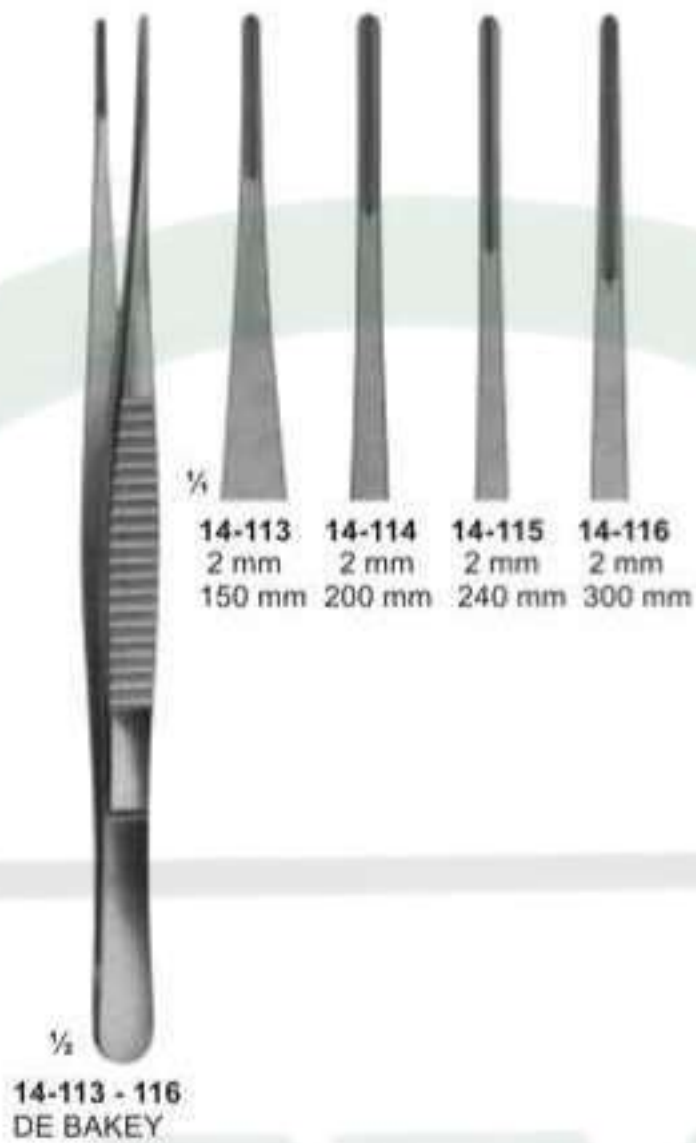
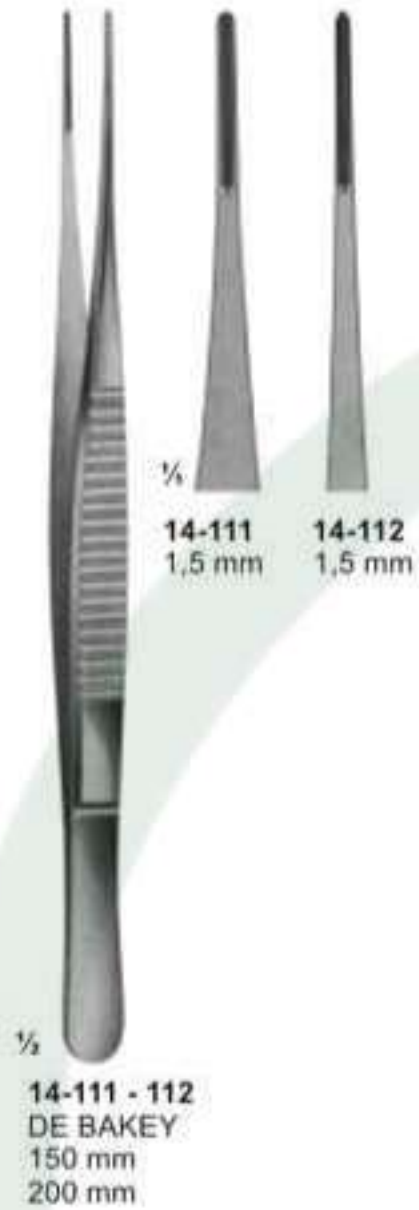



ATRAUMATA

Anastomosis- and Multi- Purpose- Clamps- Pediatric types

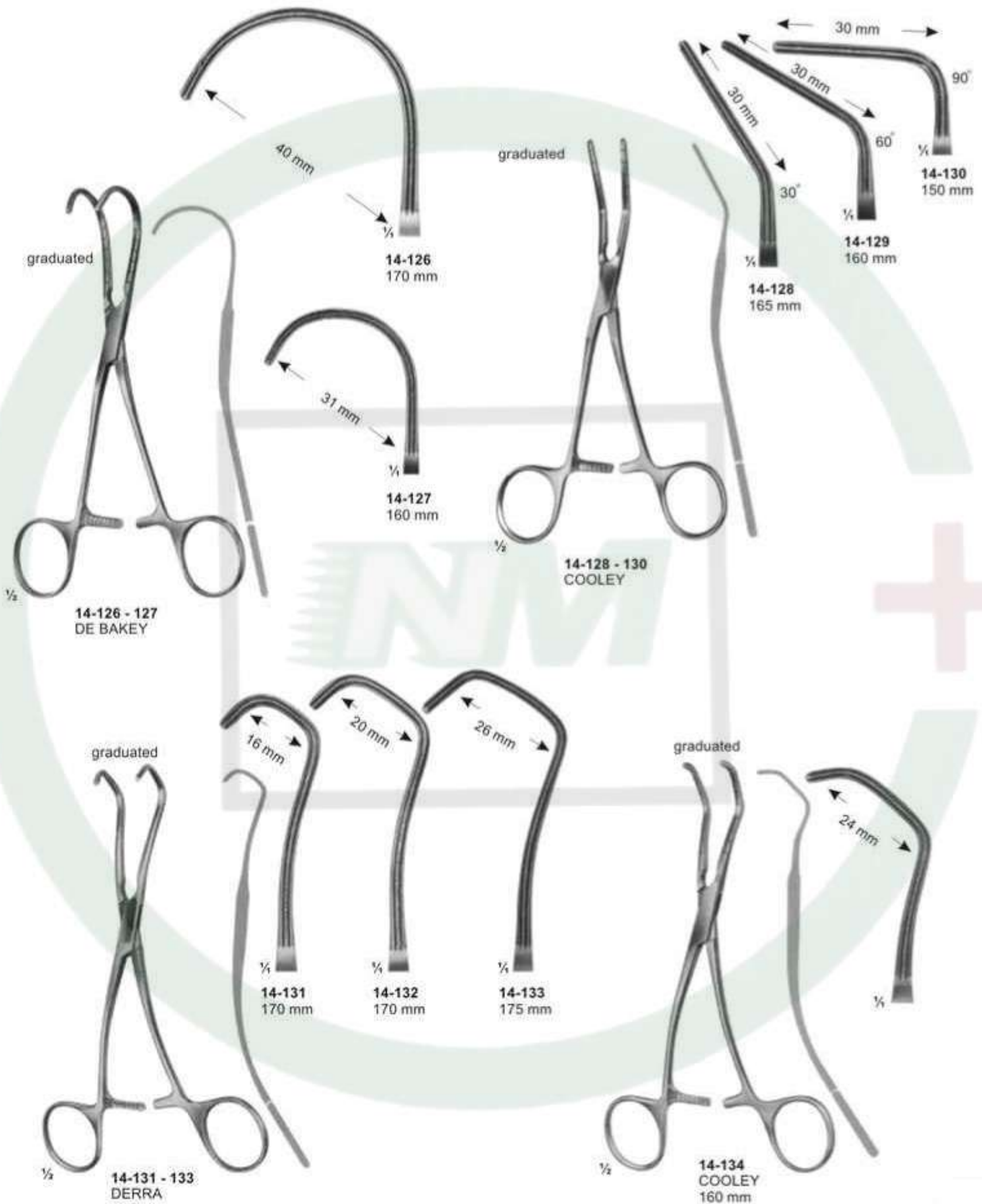



ATRAUMATA Coarctation Clamps, Patent-Ductus & Peripheral-Vascular Clamps

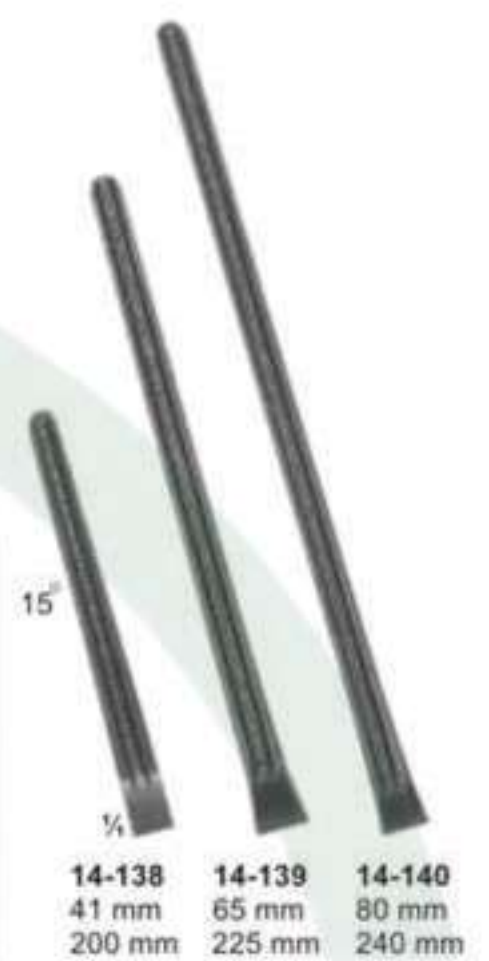



Aorta- Anastomosis Clamps

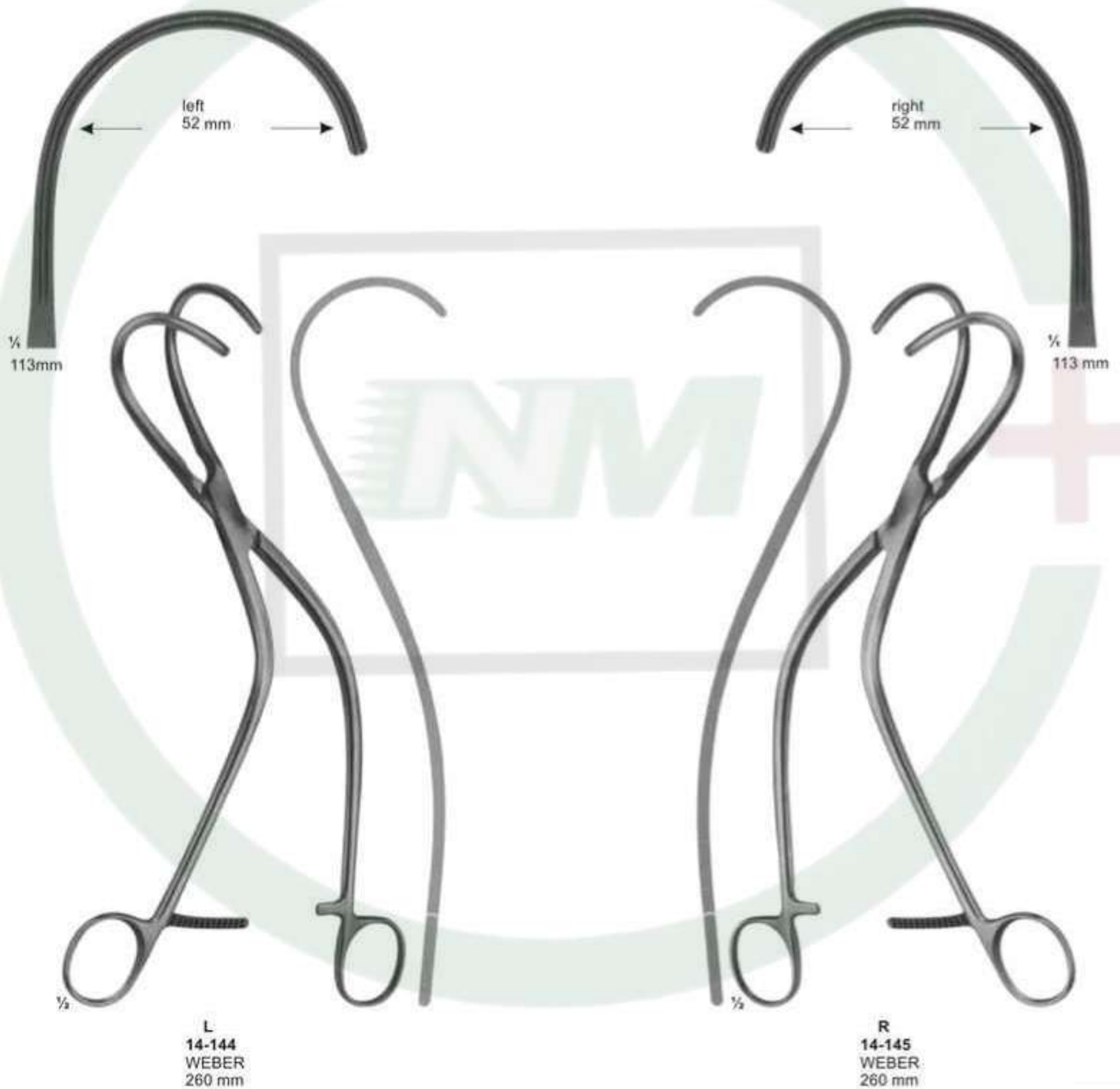



Multi- Purpose-Clamps



14-146 - 149
DE BAKLEY



Total Length:	230 mm	280 mm	305 mm	240 mm
Length of jaws:	85 mm	100 mm	135 mm	93 mm



14-150 - 153
DE BAKLEY

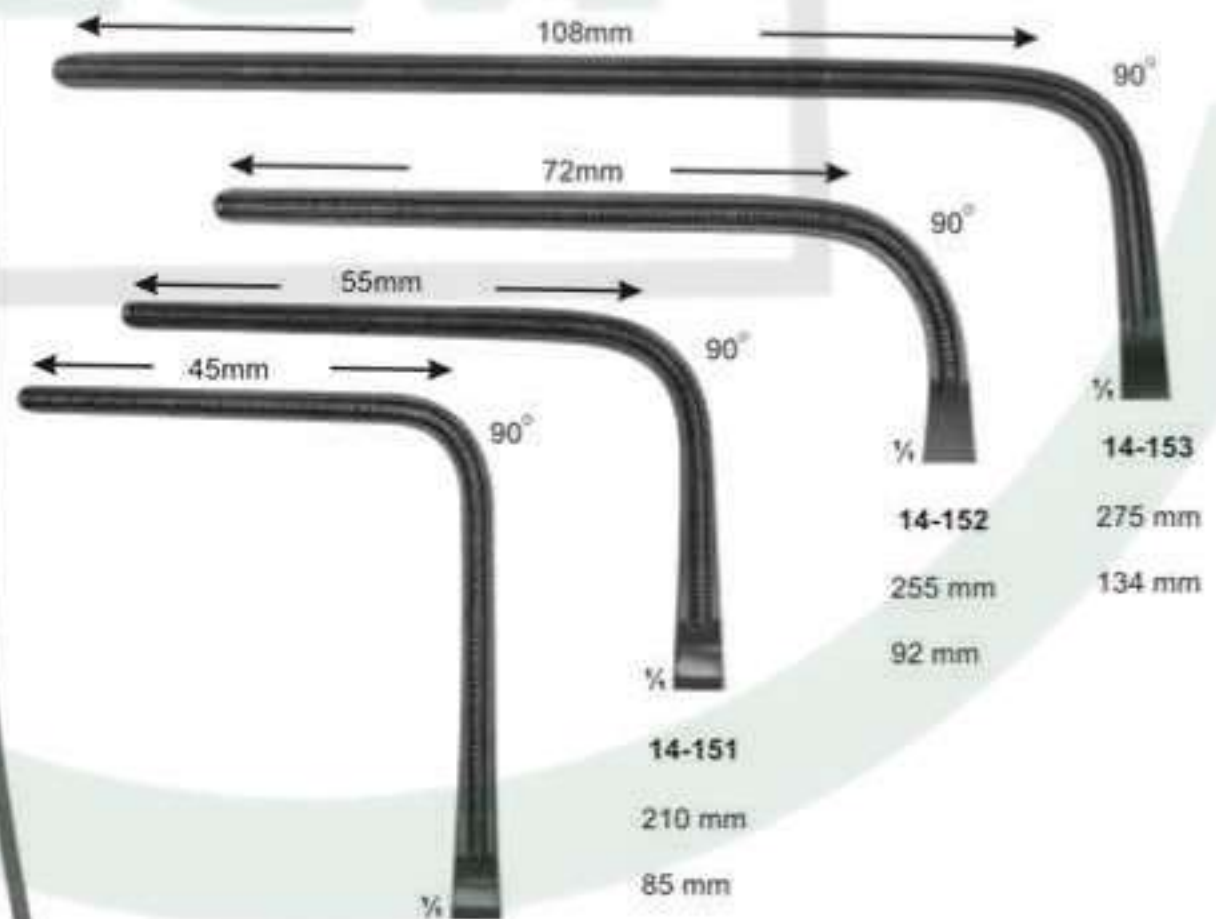

Total Length:	225 mm
Length of jaws:	93 mm



Sternum Instruments and Rib Shears



14-154
SCHUMACHER
Sternum shears
210 mm



14-155
LEBSCHÉ
Sternum chisel
200 mm



14-156
230 mm



14-157
COLLIN
195 mm



14-158
GLUCK
190 mm



14-159
BETHUNE
340 mm



14-160
BRUNNER
Universal pattern
340 mm



14-161
GIERTZ-STILLE
250 mm



Rib Spreaders



14-162
FINOCHIETTO
Blades
18X21 mm



14-163
HERTZLER
Blades
20X25 mm



14-164
TUFFIER
Blades
43X53 mm

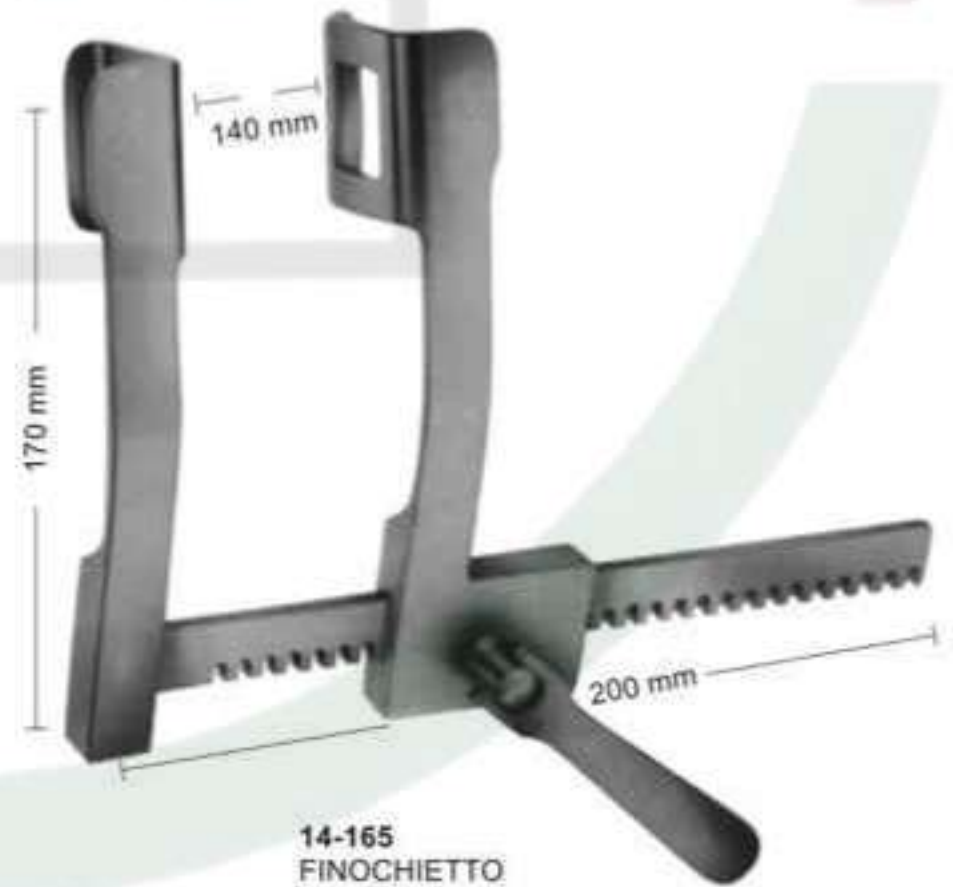

14-165
FINOCHIETTO
Blades
36X45 mm



Rib Spreaders-and Contractors





Punches

130° upwards cutting

15-101
1 mm

KERRISON - JACOBY

FERRIS-SMITH-KERRISON

15-102
2 mm

15-103
3 mm

15-104
4 mm

15-105
5 mm

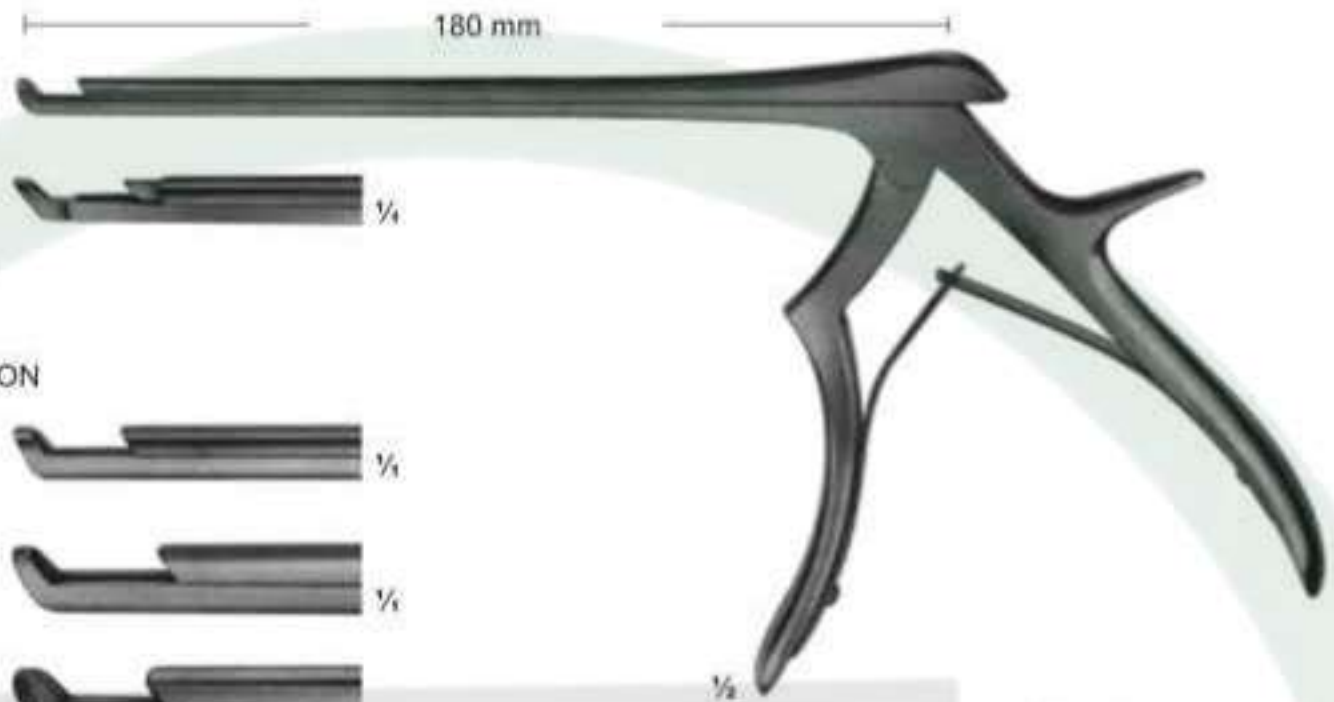

15-101 - 105

90° upwards cutting

KERRISON - JACOBY

15-106
1 mm

15-107
2 mm

FERRIS-SMITH-KERRISON

15-108
3 mm

15-109
4 mm

15-110
5 mm

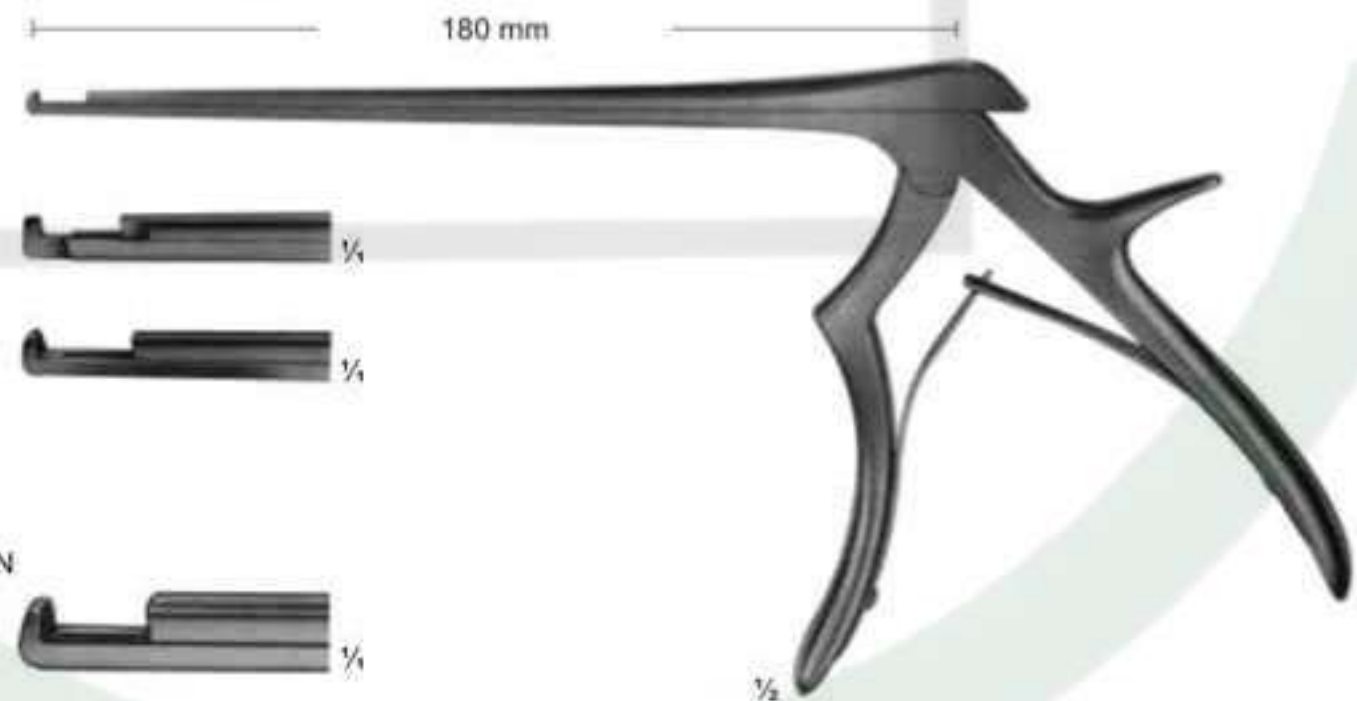

15-106 - 110



Punches

90° upwards cutting

85 mm

15-111
4 mm



1/4

15-112
5 mm



1/4

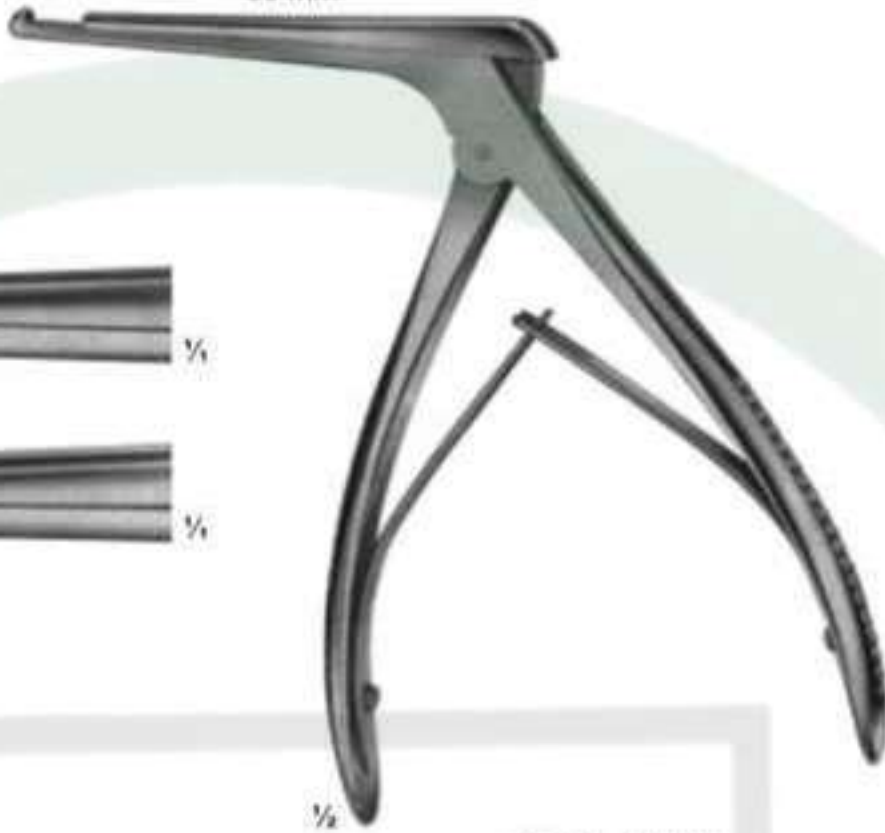

15-111 - 15-112
KERRISON

90° upwards cutting

140 mm

15-113
3.3 mm



1/4

15-114
4.0 mm



1/4

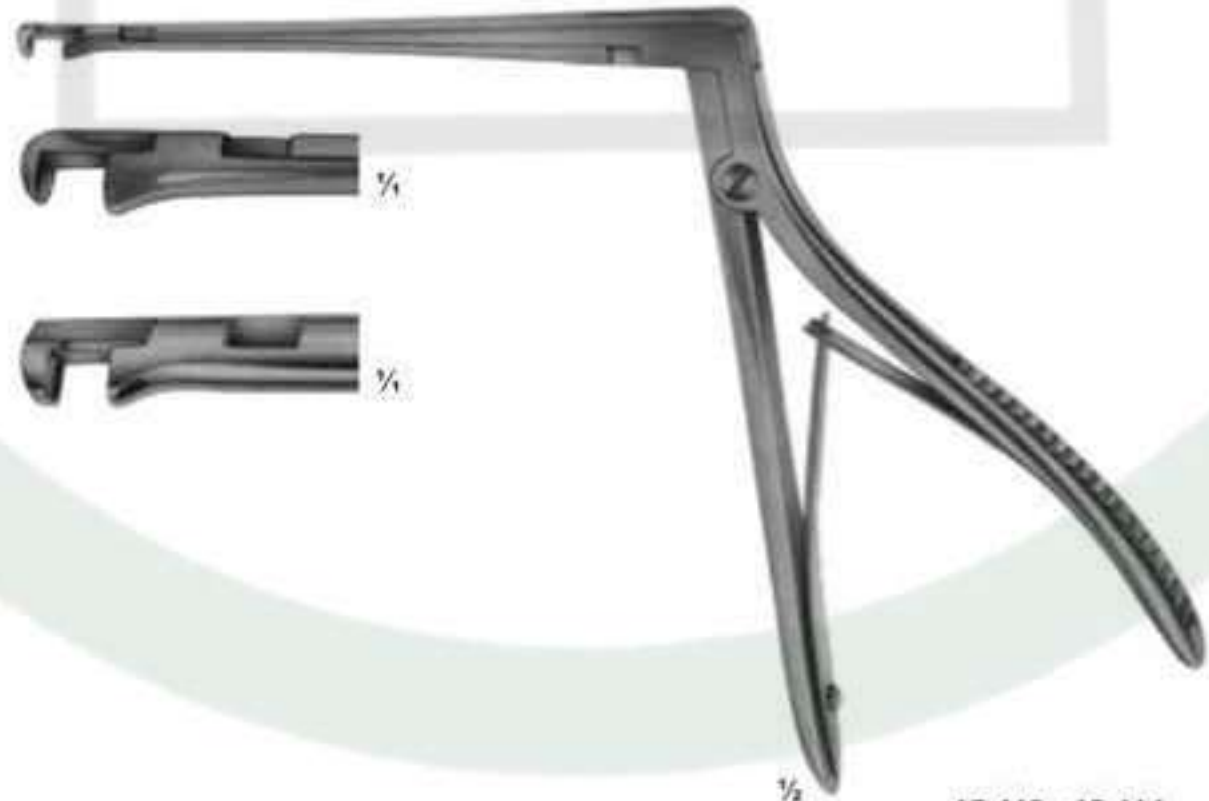

15-113 - 15-114
HAJEK-KOFLER



Rongeurs

LOVE-GRUENWALD

15-115
2 X 10 mm



15-116
3 X 10 mm



SPURLING
15-117
4 X 10 mm



130 mm



15-115 - 15-117

15-118
2 mm



15-119
3 mm



15-120
4 mm

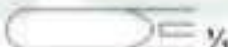

15-121
5 mm



155 mm



15-118 - 15-121
CASPAR

150°

15-122
2 mm



15-123
3 mm



15-124
4 mm



155 mm



15-122 - 15-124
CASPAR



Rongeurs

Angled positions for rongeurs

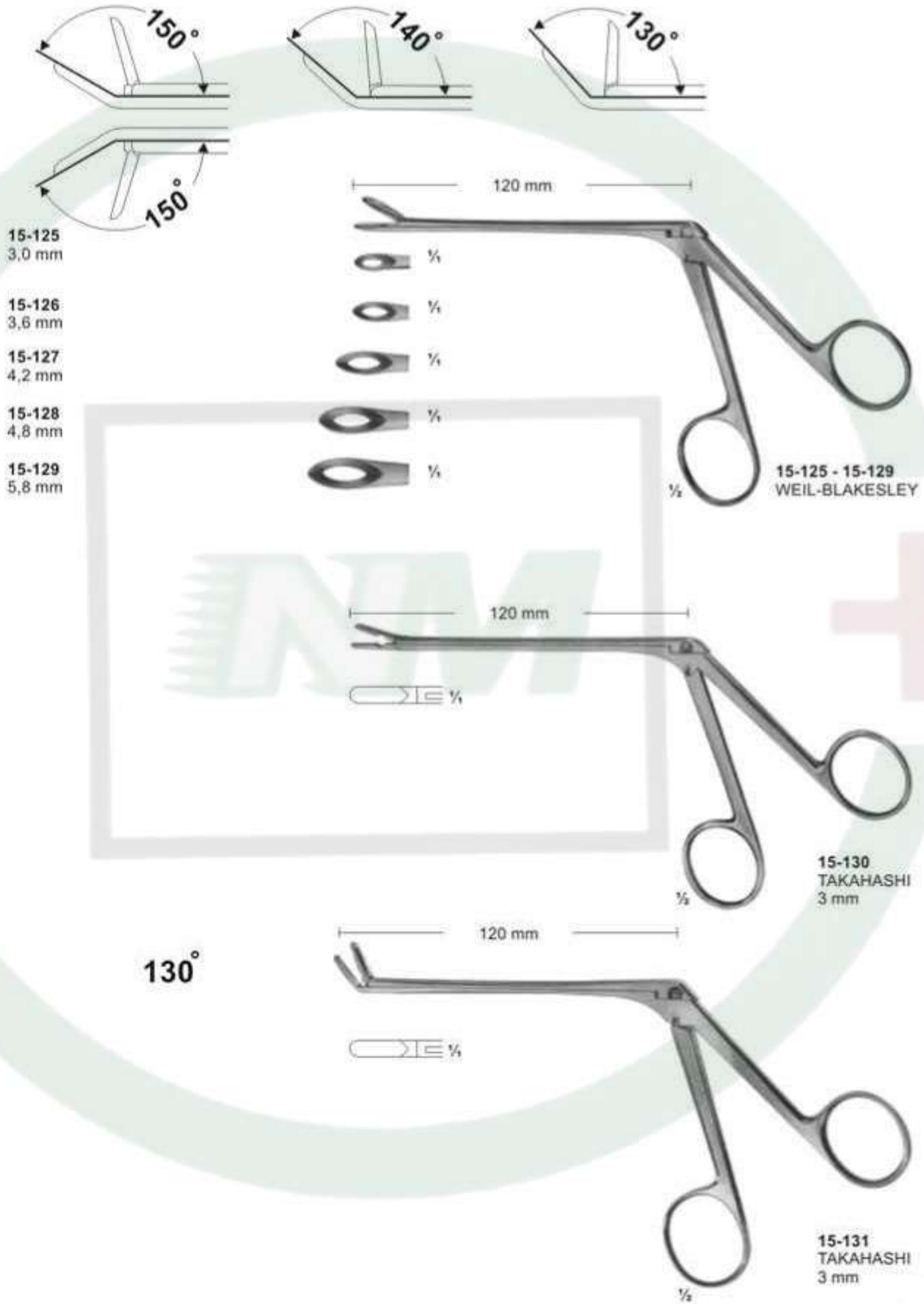



Rongeurs

150°

Lower part of jaws movable

155 mm

15-132
2 mm



15-133
3 mm

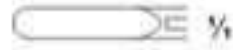

15-134
4 mm



1/2

15-132 - 15-134
CASPAR

Length of shaft
140 mm

Length of shaft
160 mm

Length of shaft
185 mm

size of jaws

15-135

15-140

15-145

2 X12 mm



15-136

15-141

15-146

3 X12 mm



15-137

15-142

15-147

4 X14 mm



15-138

15-143

15-148

5 X14 mm



15-139

15-144

15-149

6 X16 mm



1/2

15-135 - 15-149
CASPAR

150°

Length of shaft
140 mm

Length of shaft
160 mm

Length of shaft
185 mm

size of jaws

15-150

15-153

15-156

3 X12 mm



15-151

15-154

15-157

4 X14 mm



15-152

15-155

15-158

5 X14 mm



1/2

15-150 - 15-158
CASPAR



Rongeurs

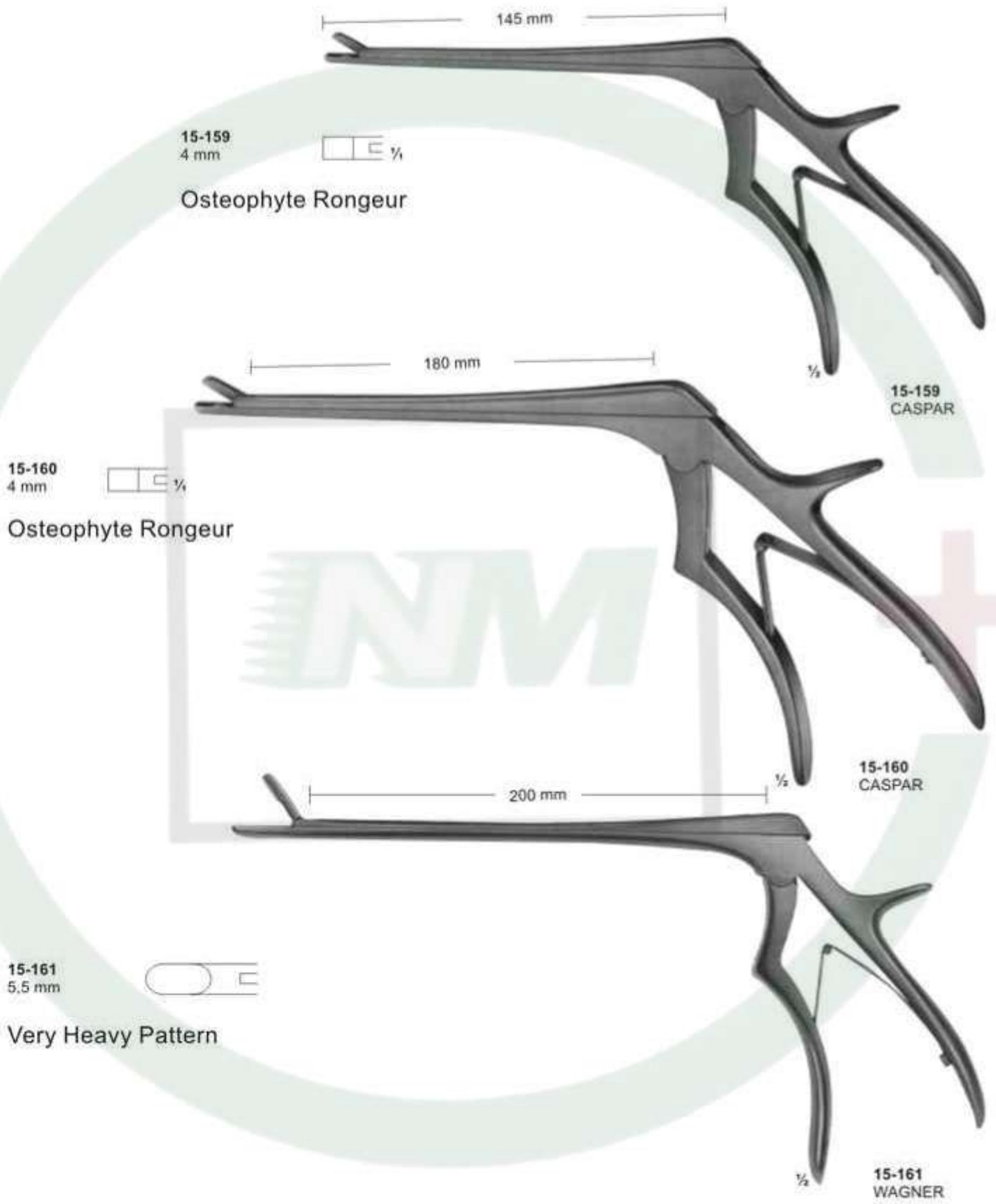



Elevators and Bone Levers

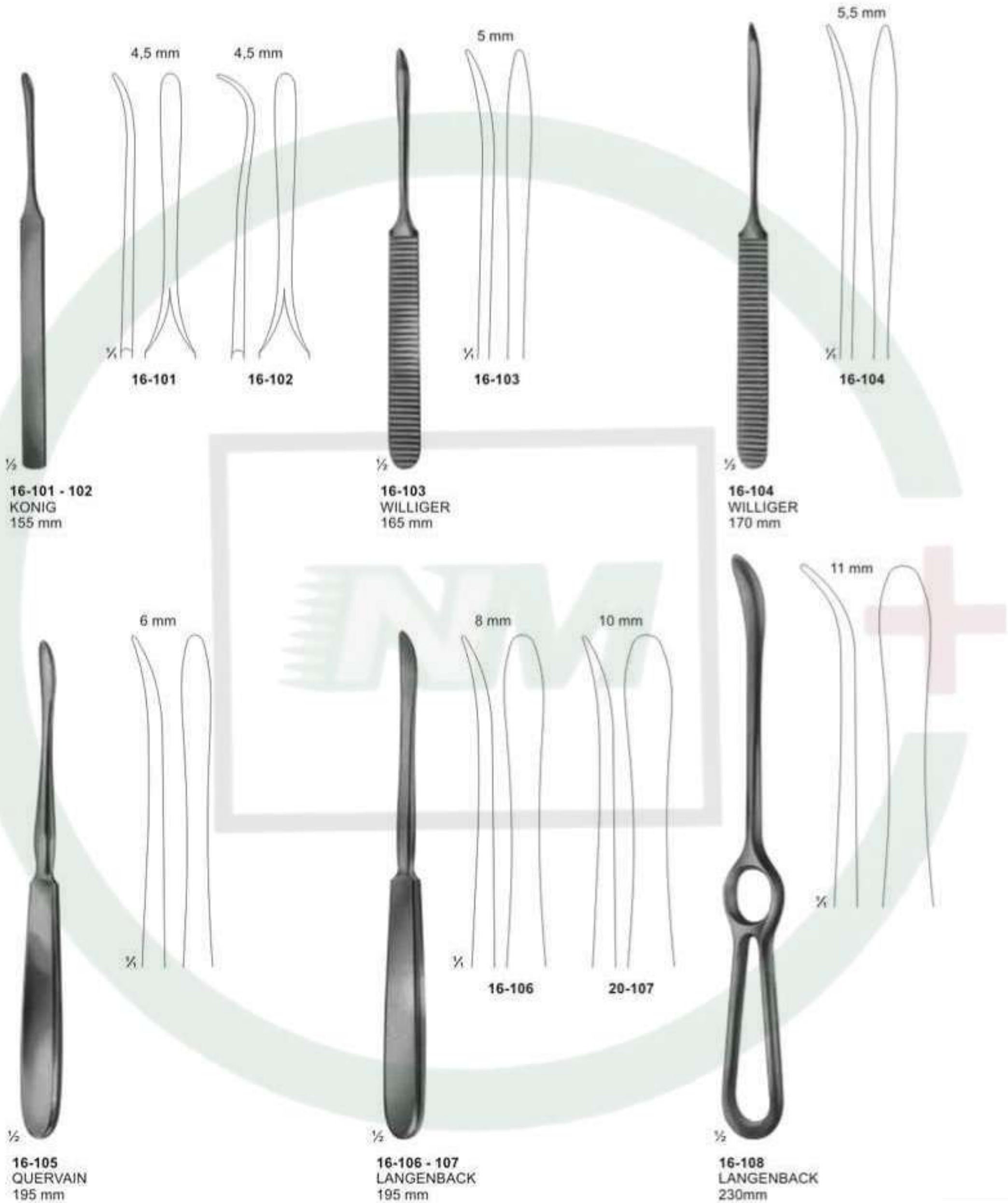



Bone Levers





Raspatories

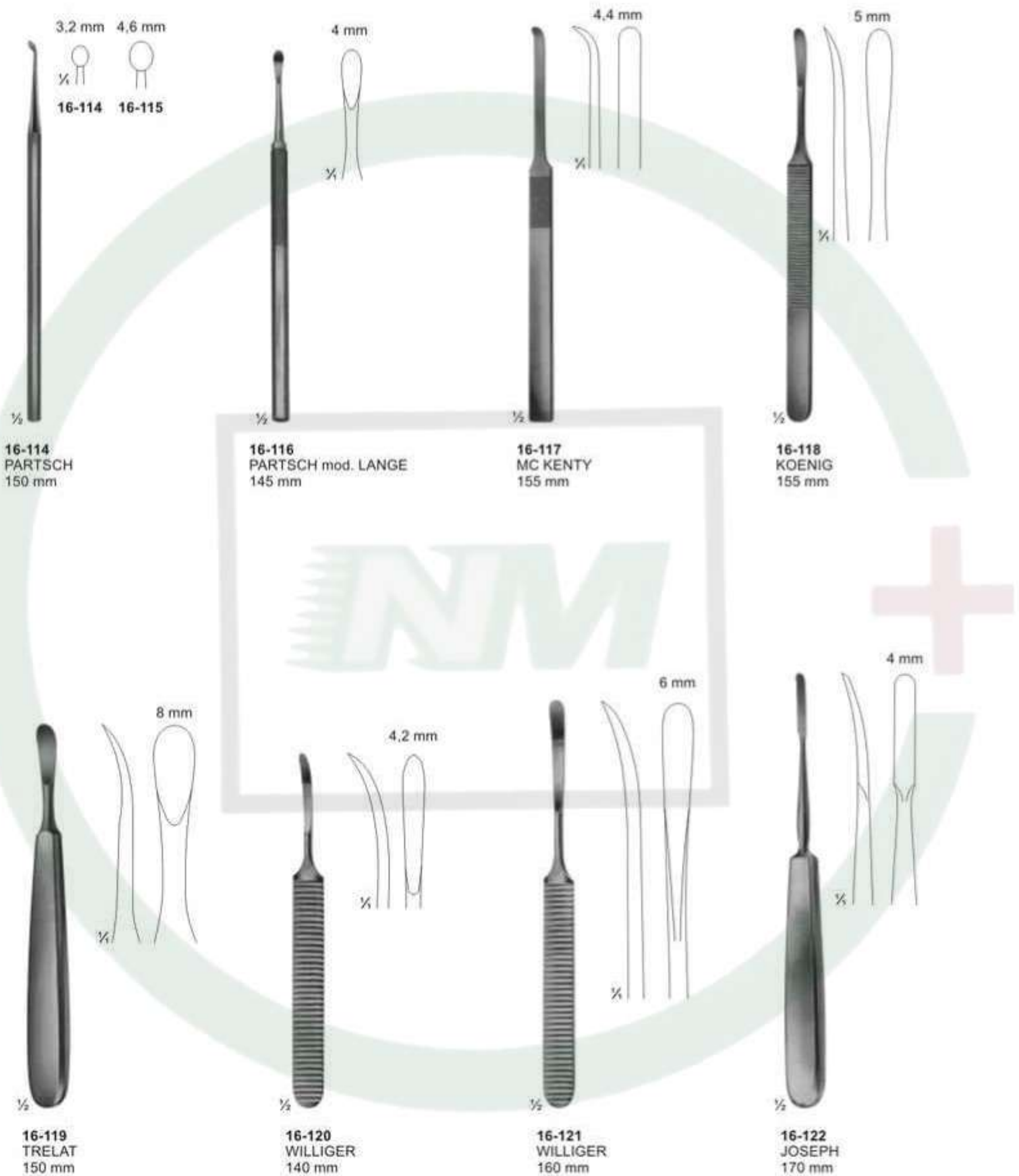



Bone File and Rasps

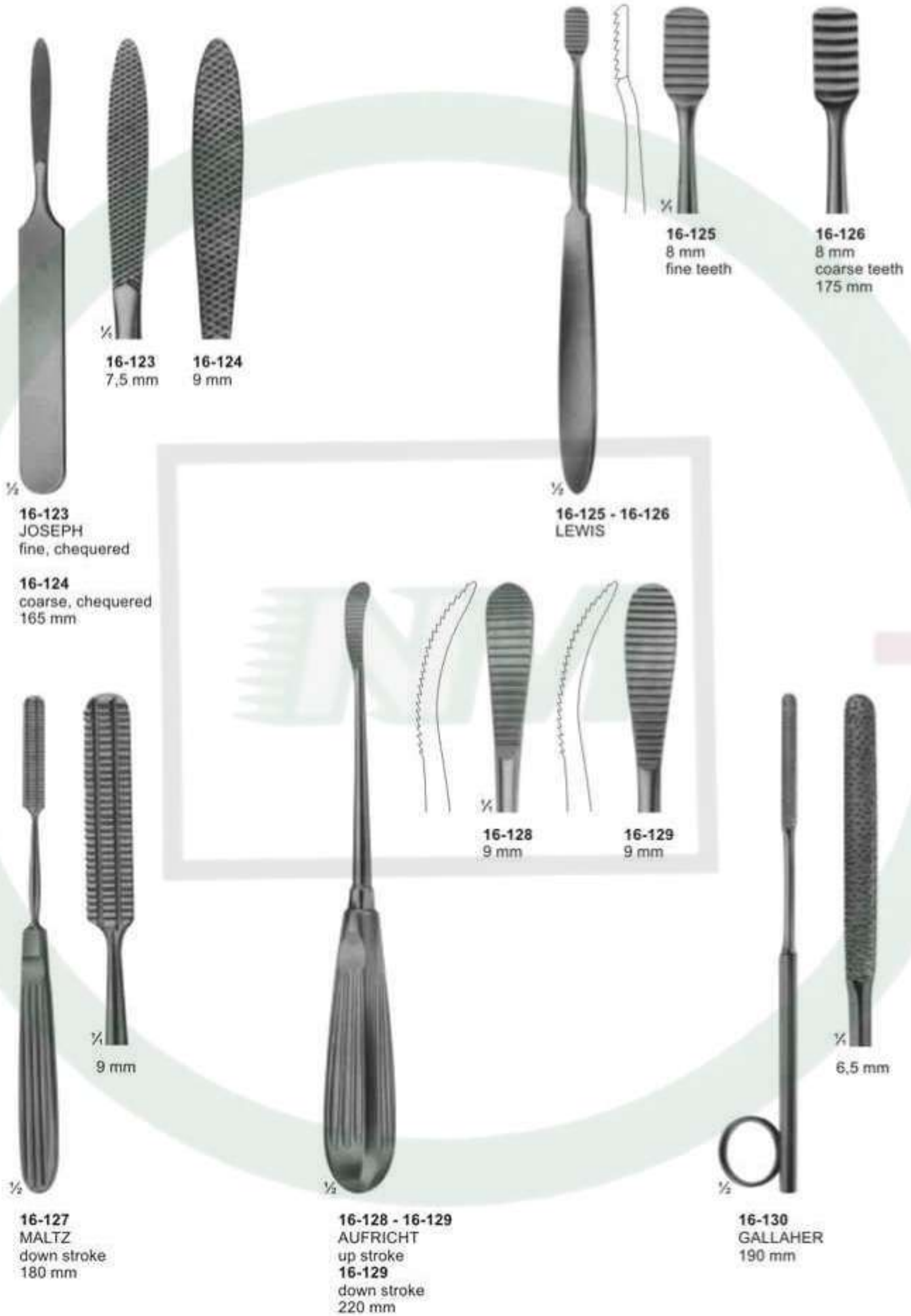



Bone Currettes



16-131
JACOBSON
140 mm



16-132
MARTINI
140 mm



16-133
MARTINI
140 mm



16-134
WILLIGER
145 mm



16-135
JANSEN
160 mm



16-136
BARTH
180 mm



16-137
VOLKMANN
130 mm



16-138
VOLKMANN
145 mm



16-139
VOLKMANN
170 mm



Mallets Weights refer to the heads of the mallets

Hammer Die Gewichtsangaben beziehen sich auf den Kopf des jeweiligen Hammers



∅ 20 mm

1/2

17-101
MEAD
185 g
with interchangeable
plastic disks
190 mm
17-102
pair of spare disks



∅ 25 mm

1/2

17-103
140 g
with interchangeable
plastic disks
185 mm
17-104
pair of spare disks



∅ 30 mm

1/2

17-105
COTTLE
140 g
1 Side Flat
1 Side convex
185 mm



∅ 22 mm

1/2

17-106
165 g
lead filled head
190 mm



Osteotomes, Chisels and Gouges

17-107 MANNERFELT Gouge
155 mm

17-108 - 112 Osteotomes
140 mm

17-108	4 mm
17-109	6 mm
17-110	8 mm
17-111	10 mm
17-112	12 mm

17-113 - 117 Chisels
140 mm

17-113	4 mm
17-114	6 mm
17-115	8 mm
17-116	10 mm
17-117	12 mm

17-118 - 122 Gouges
140 mm

17-118	4 mm
17-119	6 mm
17-120	8 mm
17-121	10 mm
17-122	12 mm

PARTSCH 17-123 - 126 Chisels
140 mm

17-123	3 mm
17-124	4 mm
17-125	5 mm
17-126	6 mm

PARTSCH 17-127 - 131 Chisels
170 mm

17-127	3 mm
17-128	4 mm
17-129	5 mm
17-130	6 mm
17-131	7 mm

PARTSCH 17-132 - 135 Gouges
140 mm

17-132	3 mm
17-133	4 mm
17-134	5 mm
17-135	6 mm

PARTSCH 17-136 - 140 Gouges
170 mm

17-136	3 mm
17-137	4 mm
17-138	5 mm
17-139	6 mm
17-140	7 mm

LUCAS 17-141 - 142 Chisels
160 mm

17-141	4 mm
17-142	6 mm

LUCAS 17-143 - 144 Gouges
160 mm

17-143	3 mm
17-144	5 mm



Reposition Forceps, Bone Holding Forceps



17-145
Patella forceps
185 mm



17-146
Forceps with
ratchet fixation
140 mm



17-147
Forceps with
thread fixation
170 mm



17-148
Forceps with
thread fixation
235 mm



17-149
DINGMANN
185 mm



Bone Holding Forceps & Bone Clamps

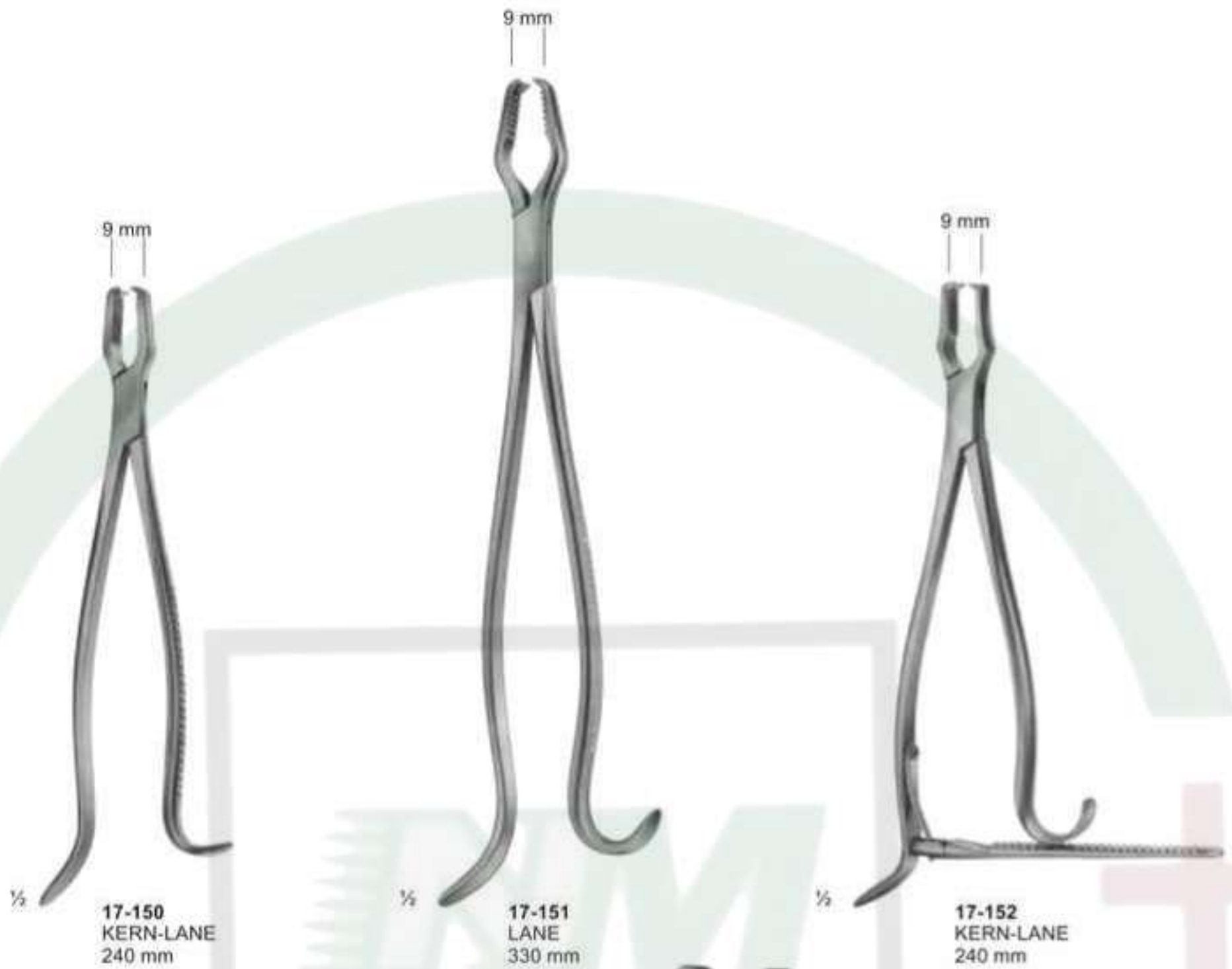

1/2
17-150
KERN-LANE
240 mm

1/2
17-151
LANE
330 mm

1/2
17-152
KERN-LANE
240 mm



17-153



1/2
17-154 - 155
LOWMAN
17-154 170 mm
17-155 205 mm



1/2
17-156
LOWMAN-GERSTER
210 mm



1/2
17-157
LOWMAN-HOGLUND
175 mm



Bone Rongeurs



17-158
LUER
150 mm



17-159
LUER
155 mm



17-160
BLUMENTHAL
155 mm



17-161
BLUMENTHAL
150 mm



17-162 - 163
JANSEN
175 mm



17-164
BANE-HARTMANN
175 mm



Bone Rongeurs



17-165
STILLE
235 mm.



17-166
LEKSELL-STILLE
240mm



17-167
STILLE-RUSKIN
240mm



Bone Cutting Forceps

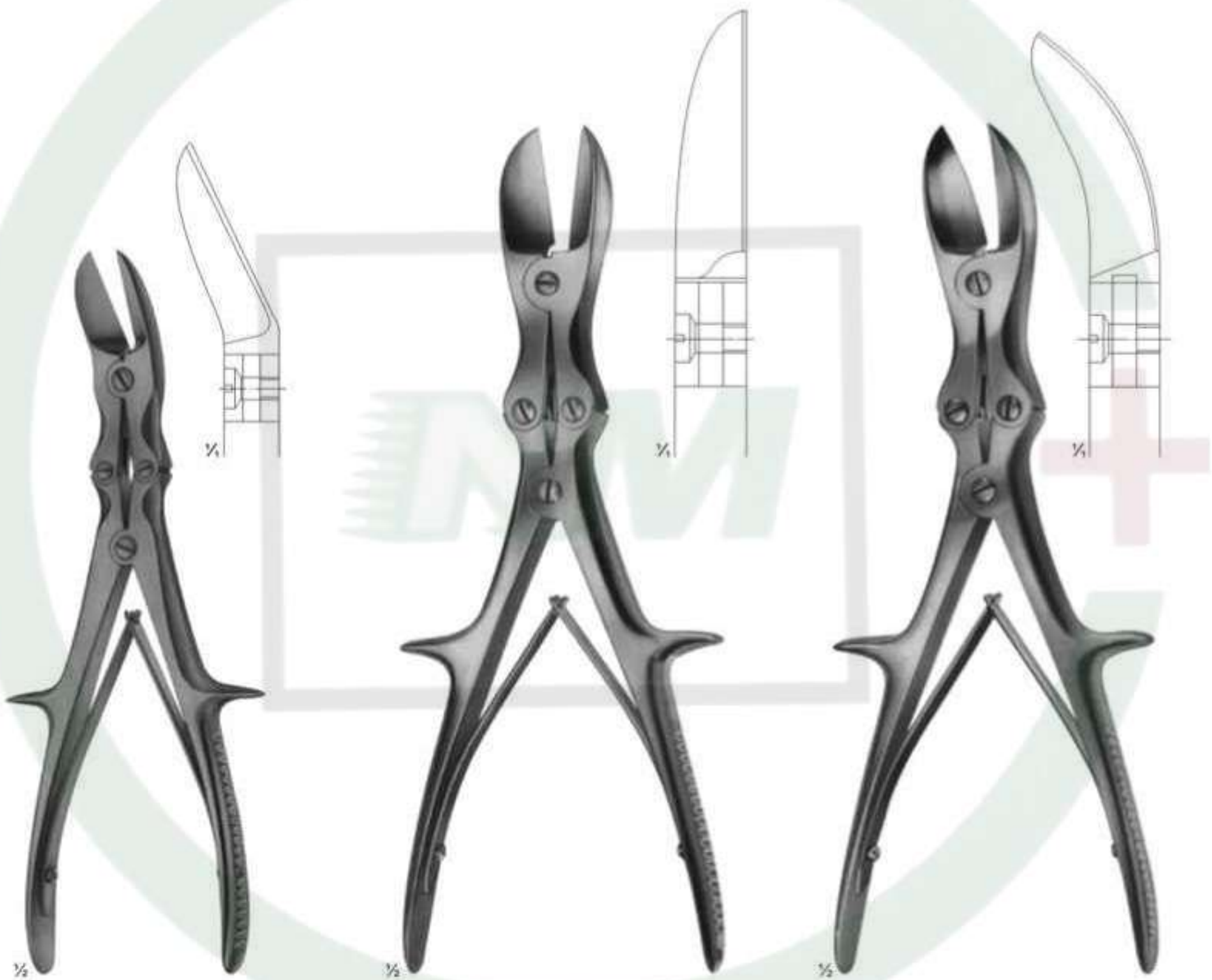

17-168
LISTON
curved on flat
240 mm

17-169
LISTON
straight
280 mm

17-170
LISTON
curved on flat
280 mm

Wire Extension

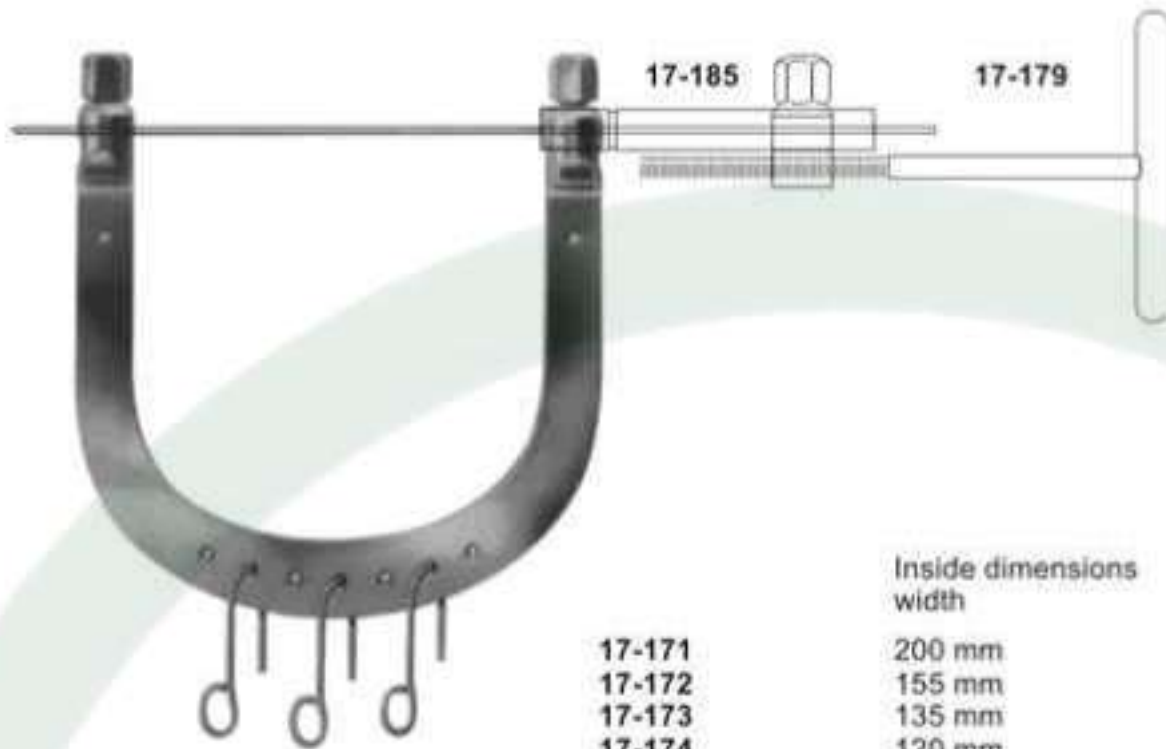

17-171 - 17-177
KIRSCHNER
Wire traction bows,
to be used with
KIRSCHNER-wires
up to 2.5 mm diam.,
With 3 hooks,
stainless steel

	Inside dimensions width	depth	
17-171	200 mm	155 mm	for the hip
17-172	155 mm	155 mm	for the femur
17-173	135 mm	130 mm	for the knee
17-174	120 mm	120 mm	for the knee
17-175	105 mm	100 mm	for the knee
17-176	95 mm	110 mm	for the calcaneus
17-177	95 mm	70 mm	for the arm and elbow



17-178
Wrench, double - ended,
for wire traction bows



17-179
Wire tightener, with
clamping jaws



American Type

17-182 max. 105 mm
17-183 max. 160 mm
17-184 max. 200 mm

17-182 80-95 mm
17-183 90-120 mm
17-184 140-170 mm

diam upto
17-182 1,6 mm
17-183 2,0 mm
17-184 2,5 mm



17-180
Traction hook only,
large size.



17-181
Traction hook only,
small size

17-182 - 17-184
KIRSCHNER
Wire traction bows, modified,
adjustable in width, holds wire
securely, with 1 hook



17-185
Fixation clamp, to secure clamping
jaws of 17-179 stainless steel



Cerclage Instruments

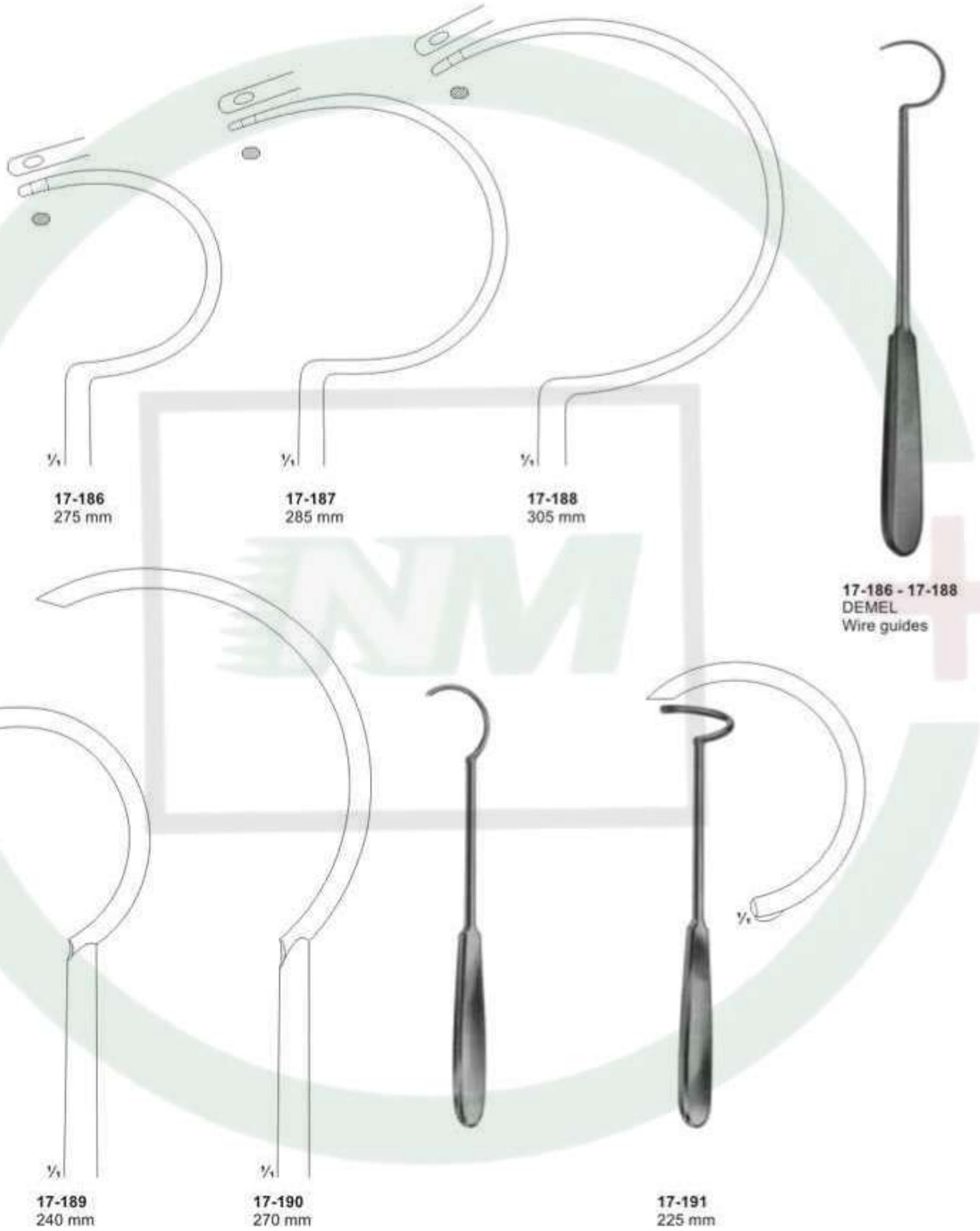



Wire Holding forceps, Wire Tightening Pliers, Flat-nosed Pliers DUROGRIP with Hard Metal Inserts



17-192
DUROGRIP
Holding forceps for cerclage wire, with lateral jaws to avoid wire slipping off
170 mm



17-193
DUROGRIP
Wire, tightening pliers, Ligature pliers
150 mm



17-194
DUROGRIP
Wire, tightening pliers, Ligature pliers
150 mm



17-195
with serrated jaws
140 mm



17-196
one jaw smooth, one jaw serrated
140 mm



17-197
with serrated jaws
17-198
with longitudinal and transversal grooves
170 mm



17-199
190 mm



Wire Holding forceps, Flat-nosed Pliers, Pliers for bending and cutting wires



17-200
130 mm

17-201
180 mm



17-200 - 17-201
Extraction pliers
for boring wires



17-202
Flat-nosed pliers,
parallel
185 mm

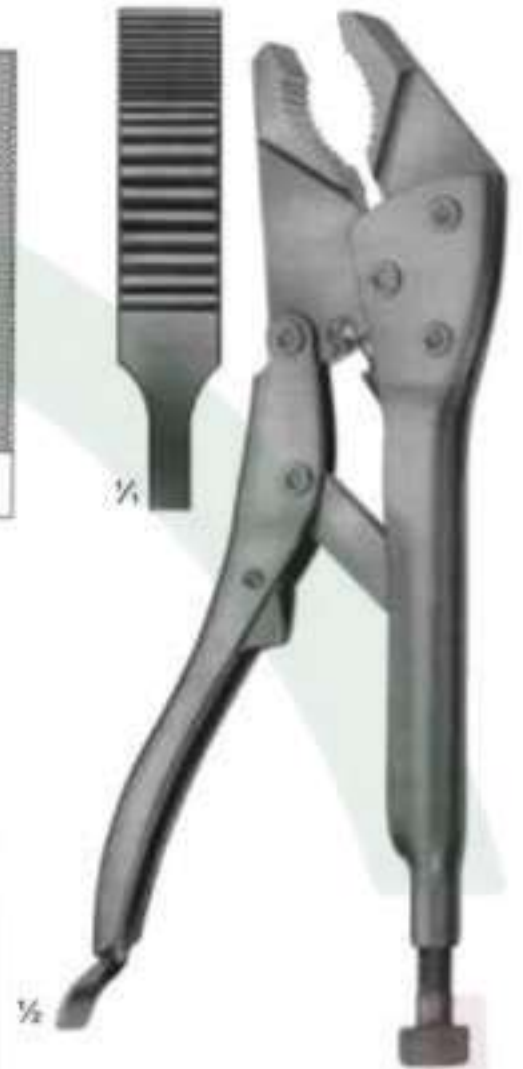

17-203
Vise grip
200 mm



17-204
Round Pliers
180mm



17-204



17-205



17-206



17-207



17-207

17-205 145 mm
17-206 180 mm
17-207 180 mm
Extraction pliers for wires

17-204 - 17-207



17-208
Bending pliers
for wires up to
1.8 mm diam.



Wire Cutters and wire Cutting Scissors DUROTIP with Carbide Cutting Edges



17-209
ANGLE
130 mm

for soft wire
up to diam.
for hard wire
up to diam.

0,5 mm
0,3 mm

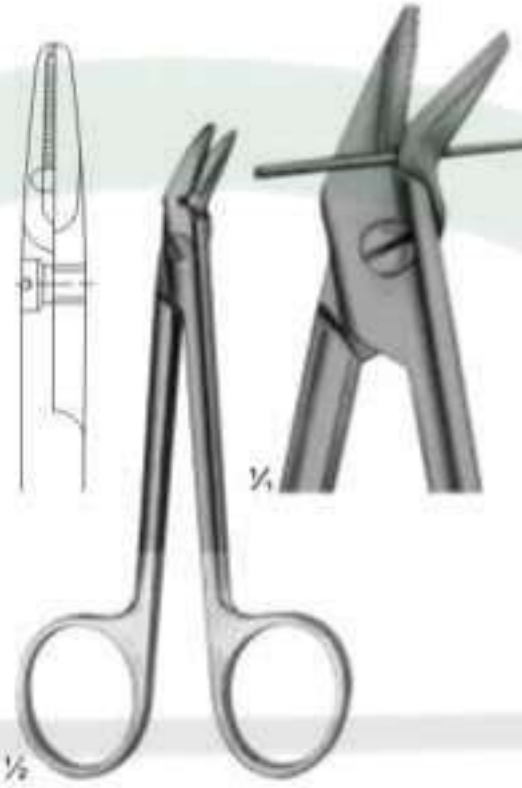

17-211
120 mm

17-212
DUROTIP
120 mm

for soft wire
up to diam.
for hard wire
up to diam.

1,2 mm
0,8 mm



17-213
HARVEY
125 mm

0,4 mm
0,3 mm



17-214
150 mm

for soft wire
up to diam
for hard wire
up to diam

1,5 mm
1,0 mm



17-215
160 mm

1,5 mm
1,2 mm



17-216
140 mm
DUROTIP
1,5 mm

1,0 mm



Wire Cutting Pliers, Lateral Cutting Action





Wire Cutting Pliers, Lateral and Front Cutting Action



pecially hardened cutting edges.

1/2

17-220
240 mm

for soft wire up to diam. 2,0 mm
For hard wire up to diam 1,6 mm



1/4

Durotip

1/2

17-221
145 mm

for soft wire up to diam. 1,5 mm
For hard wire up to diam 1,0 mm



1/4

Durotip

1/2

17-222
145 mm

for soft wire up to diam. 2,0 mm
For hard wire up to diam 1,5 mm



1/4

Durotip

1/2

17-223
220 mm

for soft wire up to diam. 3,5 mm
For hard wire up to diam 2,5 mm



Wire Cutting Pliers



17-224
320 mm

for soft wire
up to diam. 3,0 mm
For hard wire
up to diam. 3,0 mm



Cutter for cutting off
KIRSCHNER wires,
Tibia head screws,
bolts, pins, up to 3 mm diam.



DUROTIP

17-225
Cutter for cutting off
KIRSCHNER wires,
Tibia head screws,
bolts, pins, up to 6 mm diam.
470 mm

Finger Nail Instruments

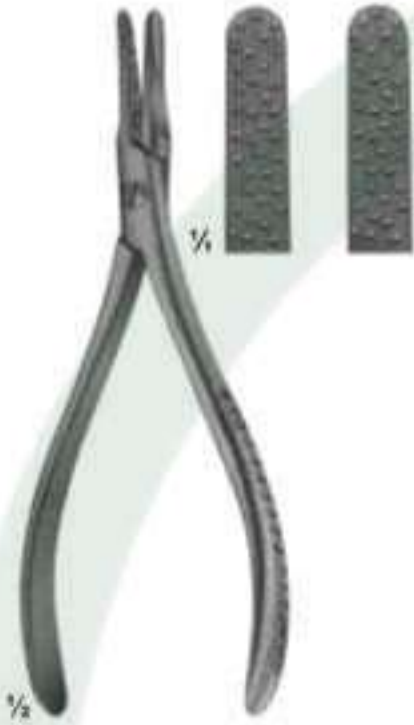

17-226
Nail extracting
forceps
135 mm



17-227
Nail extracting
forceps
145 mm



17-228
Finger nail drill
with 3 drill points.

Drill points only

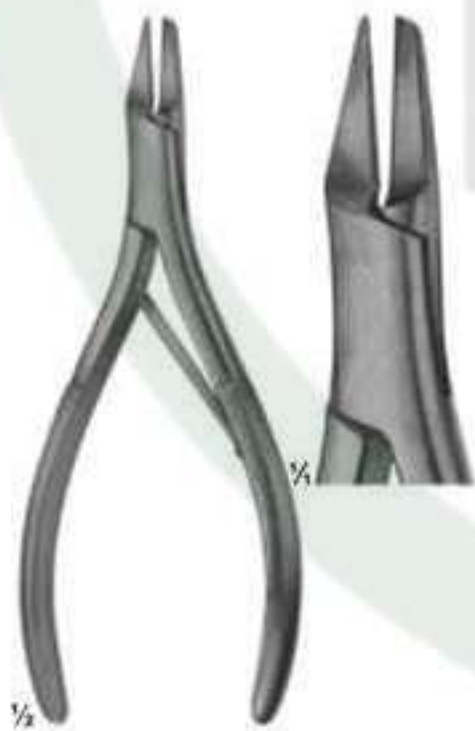

17-231
Nail splitting
forceps
135 mm



17-232
SYSTRUNK
Scissors, for splitting
finger nails
130 mm



17-233
Finger ring saw
150 mm

Spare blade
17-234



Plaster Shears



17-235
STILLE-AESCULAP
260 mm



17-236
STILLE-AESCULAP
360 mm



Plaster Spreader, Plaster Breakers



17-237
HENING
270 mm



17-238
MOD.USA
230 mm



17-239
290 mm



with removable jaws



17-240 - 17-241
WOLFF
17-240 180 mm
17-241 240 mm
plaster breakers



Vacuum Currettes for Aspiration Lipectomy, Suction Instruments



18-101 - 18-106
BIEMER
18-101 \varnothing 4 mm
18-102 \varnothing 6 mm
18-103 \varnothing 8 mm
18-104 \varnothing 10 mm
18-105 \varnothing 12 mm
18-106 \varnothing 14 mm
Currettes for aspiration lipectomy, graduated, slightly curved

18-107 - 18-108
BIEMER
18-107 \varnothing 4 mm
18-108 \varnothing 6 mm
Currettes for aspiration lipectomy, with three apertures, slightly curved malleable

18-109 - 18-111
BIEMER
18-109 \varnothing 8 mm
18-110 \varnothing 10 mm
18-111 \varnothing 12 mm
Currettes for aspiration lipectomy, with three apertures, slightly curved malleable

18-112
For aspirating fluid from the excretory ducts of large glands and for keeping the operating area clear
170 mm

18-113
Trocar
For puncturing
150 mm

18-114
For clearing large quantities of fluid
190 mm



Suction Instruments

18-115 150mm
Suction handle, with vacuum regulator and finger cut-off, brass, mirror-finish chromium-plated



olive
Ø 9 mm

18-116 170mm
Suction handle, with hand regulation valve and quick-shutter, brass, mirror-finish chromium-plated



Both suction handles have bayonet fitting Olive and can be used for the suction cannulae. Ø 9 mm



18-117
Trocar
For puncturing
170 mm



18-118
Hollow needle,
sharp
150 mm



18-119
double curved
For general
surgery
230 mm



18-120
For tonsillectomy,
oral and laryngeal
operations
190 mm



Ø 7.5 mm

18-121
For tonsillectomy,
oral and laryngeal
operations
220 mm

★ With bayonet fitting to be used with suction handles (18-115 - 18-116)



Suction Instruments

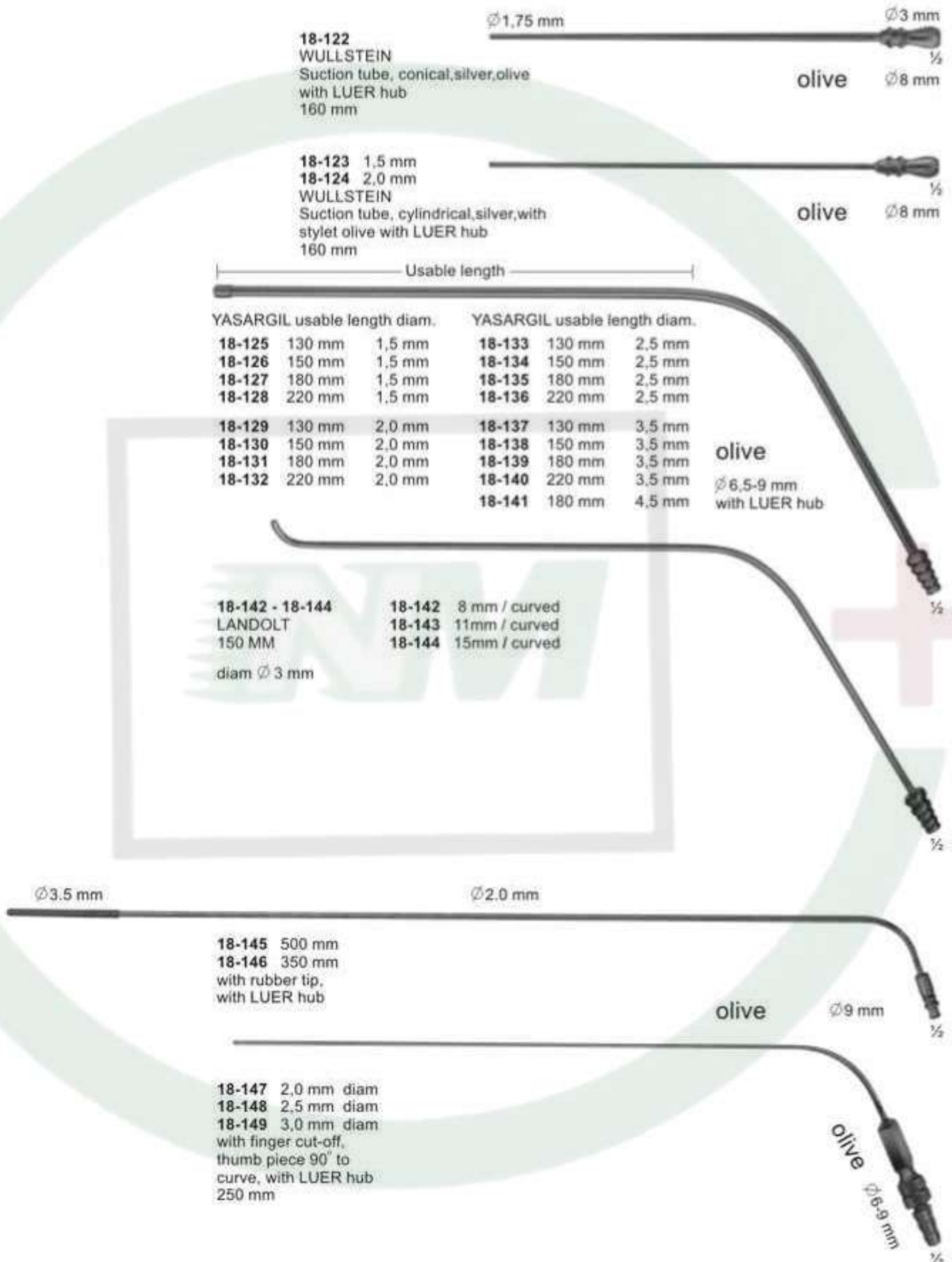



Combined Suction and Irrigation Cannulae, Coagulation Suction Cannulae

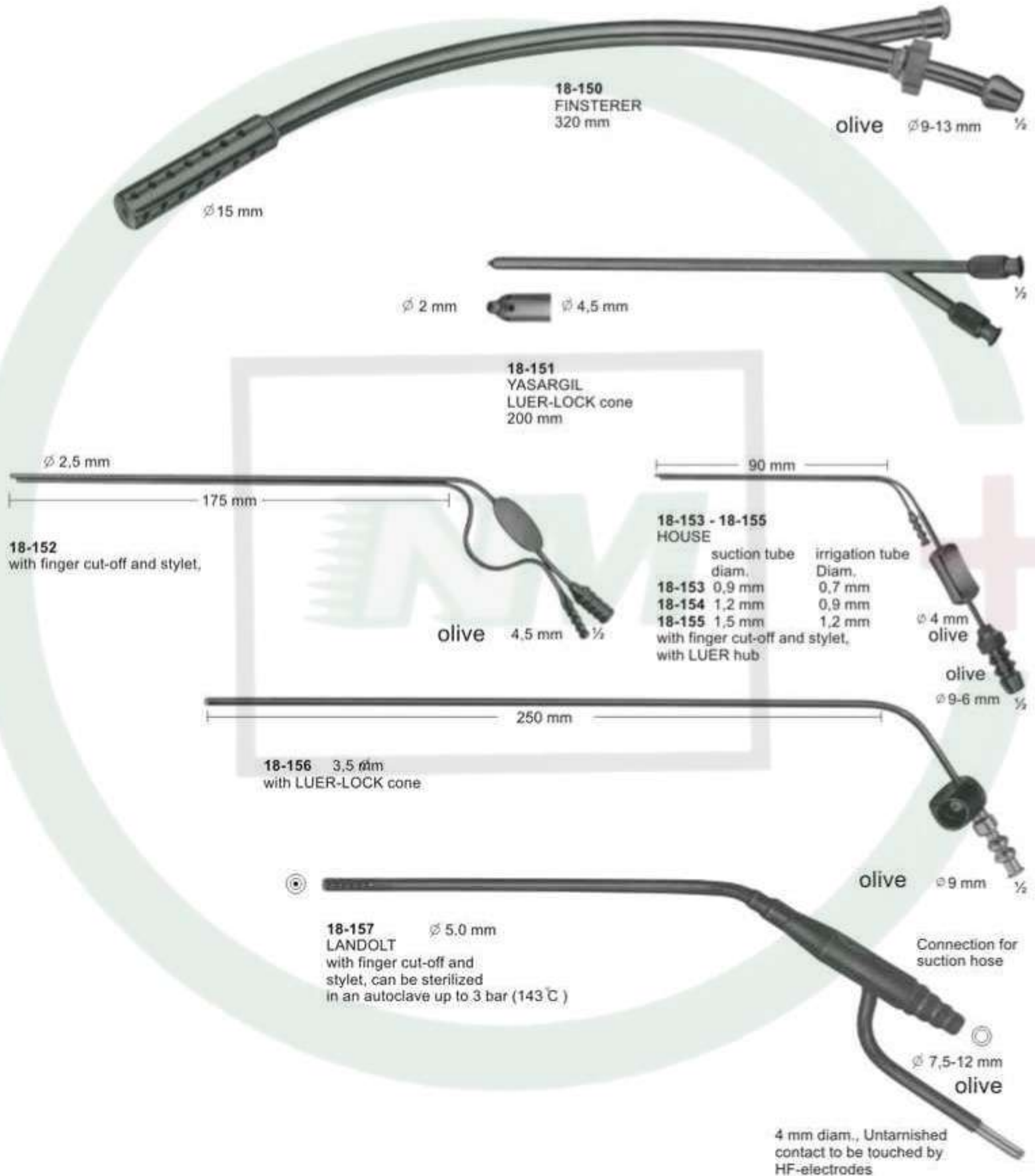



Suction Instruments

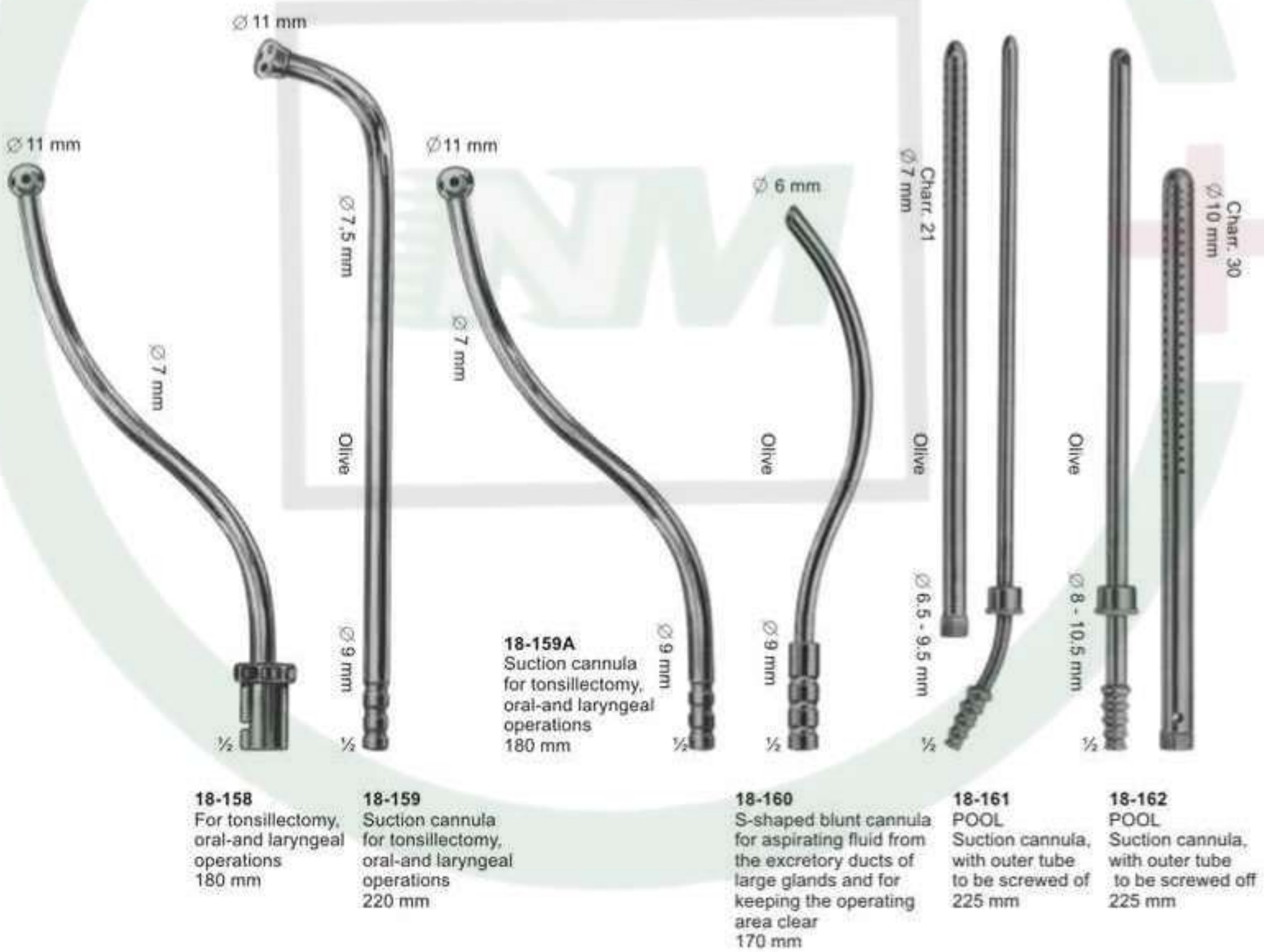

Suction Instruments

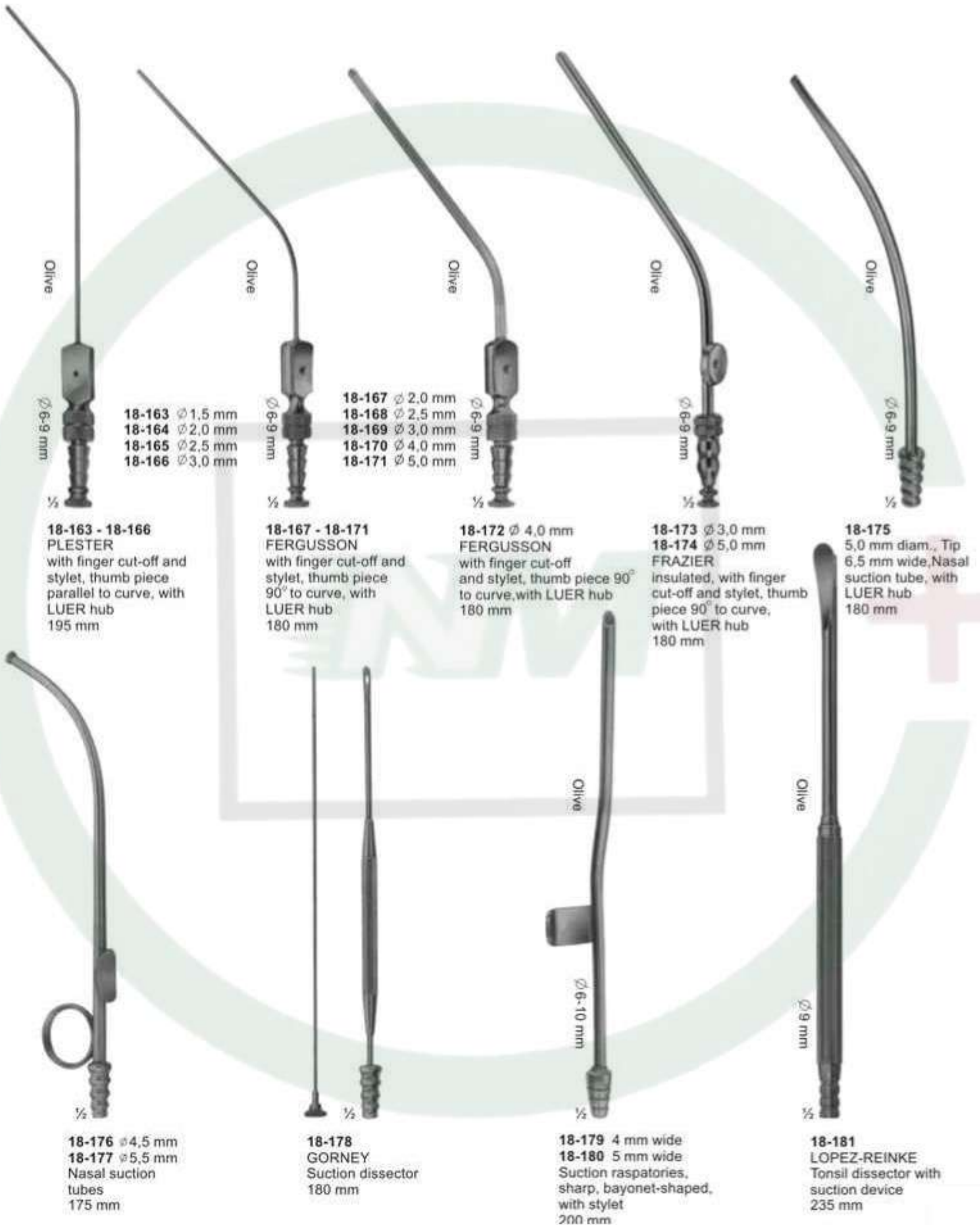



Dissection Instruments



18-182

- 1- Blow pipe .
- 2- 3 PCS .scalpel.
- 3- Dissecting forcep 13 cm.
- 4- Grooved director with tounge tie 13 cm.
- 5- Triple chain hook.
- 6- Dressing scissors probe pointed 13 cm.
- 7- Probe double 13 cm.
- 8- Zipper case inside red velvet.



18-183

- 1- Probe Double 13 cm
- 2- 2 PCS. Scalpel S.S
- 3- Grooved Director With tongue Tie 13 cm
- 4- Mayo Hegar Needle Holder 13cm
- 5- Dissecting Forcep 13 cm 1x2 Teeth
- 6- Dressing Forcep 13 CMS Serrated.
- 7- Dressing Scissor 13 cm S/B STR.
- 8- Dressing Scissor 13 cm S/B CVD.
- 9- Zipper Case Inside Red Velvet.

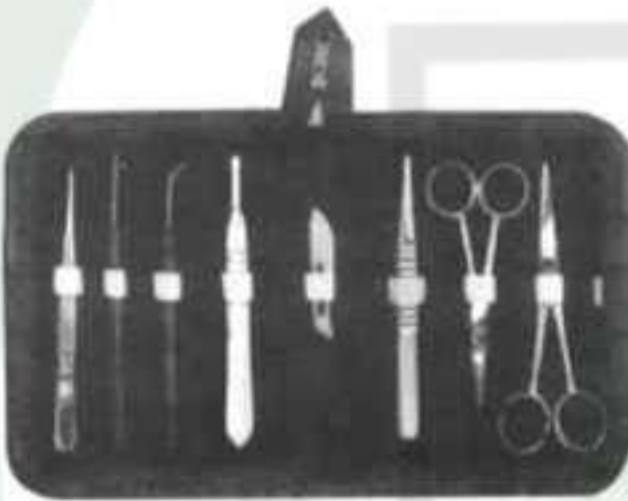

18-184

- 1- Dissecting Forcep 11.5 cm Sharp Point.
- 2- Iris Scissor
- 3- B.P Handle No. 4
- 4- Teasing Needle Sharp angular.
- 5- Blade No. 22
- 6- Thumb Forceps T.O.E 13 cm
- 7- Dissecting Scissor STR 11.5 cm
- 8- Dissecting Scissor STR 13 cm
- 9- Zipper case Inside Red Velvet

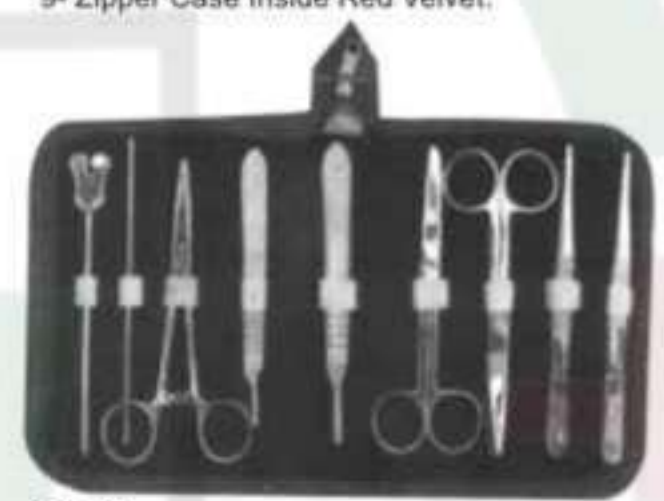

18-185

- 1- Grooved Director with Tongue Tie 14 cm
- 2- Probe Double 14cm
- 3- Mayo Hegar Needle Holder 14 cm
- 4- BP. Handle no.3
- 5- BP. Handle no.4
- 6- Dressing Scissor 14 cm S/B STR
- 7- Dressing Scissor 14 cm S/B CVD.
- 8- Dressing Forcep 1x2 Teeth 14 cm
- 9- Dressing Forcep Serrated 14 cm



18-186

- 1- Probe double 12.5 cm
- 2- Scalpel
- 3- B.P Handle No. 4
- 4- 6 PCS Blade 2 each no. 21, 22, 23
- 5- Dissecting Forcep 12.5 cm
- 6- Dissecting Forcep 11.5 cm sharp Point
- 7- Dissecting Scissor S/B STR 13 cm
- 8- Dissecting Scissor S/S STR 13 cm



18-187

- 1- Teasing Needle with Chuck CVD.
- 2- Huber Probe
- 3- Iris Scissor
- 4- Dissecting Forcep Fine 14 cm.
- 5- Dissecting Forcep Fine CVD. 12 cm
- 6- Operating Scissor with Probe 14 cm.
- 7- B.P. Handle no. 4

Dissection Instruments



18-188

- 1- Probe with eye
- 2- Dissecting Forcep cvd fine 12 cm.
- 3- Iris Scissor
- 4- Operating Scissor S/B str 14 cm
- 5- Grooved Director and Tongue tie
- 6- Huber Probe
- 7- Triple Chain Hook
- 8- B.P Handle No. 4
- 9- B.P Handle No. 3
- 10- Teasing Needle with Chuck cvd.
- 11- Teasing Needle with Chuck str.
- 12- Dissecting Forceps Fine 14 cm.



18-189

- 1- Grooved Director and Tongue tie
- 2- Mayo Harg Needle Holder 14 cm
- 3- B.P Handle No. 4
- 4- Dissecting Forceps Thump 14 cm.
- 5- Operating Scissor S/B str 14 cm
- 6- Kelly Forcep STR 14 cm.
- 7- Probe Double end

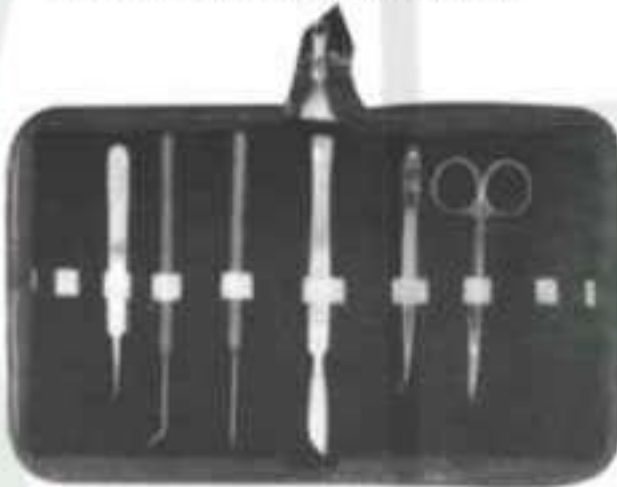

18-190

- 1- Iris Scissor STR
- 2- Dissecting Forceps CVD 12 cm.
- 3- Scalpel
- 4- Teasing Needle STR wooden handle.
- 5- Teasing Needle CVD wooden handle.
- 6- Watchmaker fine point.



18-191

- 1- Probe Double end
- 2- B.P Handle No. 4
- 3- Dissecting Forcep 1x2 Teeth 14 cm.
- 4- Operating Scissor S/B str 14 cm
- 5- Mayo Harg Needle Holder 14 cm
- 6- Kelly Forcep STR 14 cm.
- 7- Operating Scissor S/B CVD 14 cm
- 8- Grooved Director and Tongue tie
- 9- Dissecting Forceps Thumb 14 cm.



18-192

- 1- Probe double end.
- 2- Grooved director and tounge tie.
- 3- B.P handle no.4
- 4- Operating scissor STR S/b14cm.
- 5- Kelly forceps STR 14cm.
- 6- Dissecting forceps thumb 13cm.



18-193

- 1- Dissecting Forceps Thumb 14 cm
- 2- Dissecting Forcep 1x2 Teeth 14 cm.
- 3- B.P Handle No. 3
- 4- Grooved Director and Tongue tie
- 5- Mayo Harg Needle Holder 14 cm
- 6- Operating Scissor S/B str 14 cm
- 7- Probe Double end
- 8- Kelly Forcep STR 14 cm.



Dissection Instruments

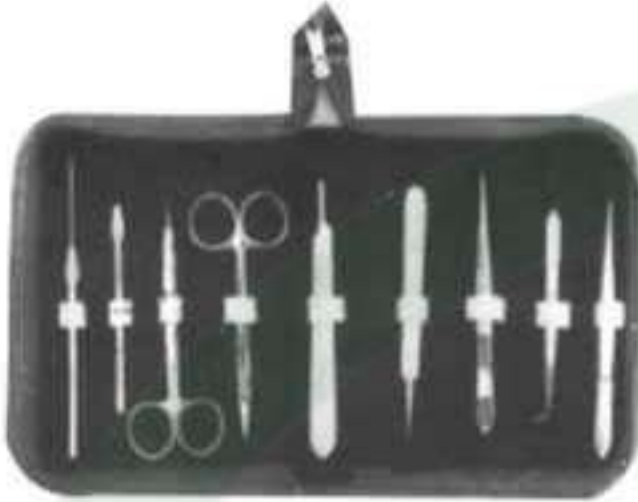

18-194

- 1- Dissecting Forcep Fine 14cm.
- 2- Dissecting Forcep Fine CVD 12cm
- 3- Dissecting Forcep with Pin 14cm.
- 4- Watchmaker Fine point
- 5- Iris scissor STR
- 6- Iris scissor CVD.
- 7- Teasing Needle holder
- 8- Teasing Needle STR.
- 9- B.P. Handle no. 3



18-195

- 1- Teasing Needle STR.
- 2- Grooved Director and Tongue Tie.
- 3- Teasing Needle CVD.
- 4- Dissecting Forcep with Pin 12 cm Fine
- 5- Operating Scissor S/B STR 14 cm
- 6- Triple Chain Hook
- 7- Probe with eye
- 8- Probe Double end
- 9- Probe and Hook
- 10- Dissecting Forcep Fine 14 cm
- 11- Iris Scissor
- 12- Huber Probe
- 13- B.P. Handle no.3
- 14- B.P. Handle no.4



18-196

- 1- Dissecting forcep fine STR with pin 12cm.
- 2- Iris scissor STR.
- 3- Probe with eye.
- 4- Probe and hook.
- 5- Operating scissor S/B STR 14cm
- 6- Triple chain hook.
- 7- B.P. handle no.4
- 8- Humber probe.
- 9- B.P.handle no.3
- 10- Teasing needle STR plastic handle.
- 11- Teasing needle CVD plastic handle.
- 12- Grooved director and tongue tie.
- 13- Probe double end.



18-197

- 1- Dissecting Forceps Thumb 14 cm.
- 2- Dissecting Forcep 1x2 Teeth 14 cm.
- 3- B.P Handle No. 3
- 4- Grooved Director and Tongue tie
- 5- Mayo Hearn Needle Holder 14 cm
- 6- Operating Scissor S/B str 14 cm
- 7- Probe Double end
- 7- Kelly Forcep STR 14 cm.



Hospital Wares



19-101 - 115
Schimmelbusch

Ø x H
sizes in mm

19-101	80 x 80
19-102	105 x 120
19-103	140 x 140
19-104	160 x 120
19-105	160 x 150
19-106	190 x 150
19-107	190 x 190
19-108	240 x 160
19-109	240 x 240
19-110	290 x 160
19-111	290 x 240
19-112	340 x 160
19-113	340 x 340
19-114	390 x 190
19-115	390 x 290



19-116
Box
120 x 65 x 13mm
(without Bulldog clamps,
without silicone tape)



19-117
Box with support
120 x 65 x 13 mm
(ohne Bulldogklemmen)



19-118
Box with support for
needle electrodes,
without instruments



19-119 - 121
50 x 25 x 4,5 mm
19-120
65 x 42 x 8 mm
19-121
75 x 25 x 4,5 mm



19-122
Ø 65mm x 15mm



Hospital Wares



19-123 - 131

	∅ x H
19-123	30 x 90 mm
19-124	50 x 100 mm
19-125	50 x 130 mm
19-126	50 x 175 mm
19-127	75 x 100 mm
19-128	75 x 130 mm
19-129	75 x 175 mm
19-130	100 x 175 mm
19-131	100 x 200 mm

19-141 - 142

- 19-141** Martin Sterilizing Forceps consisting of:
 1 Sterilizing Forceps, curved, 25 cm, without ratchet, with lid for jar
 1 jar with bottom plate (anti-tilt)
- 19-142** ditto, with 32 cm long Sterilizing Forceps



19-132 - 139

19-132	165 x 85 x 35 mm
19-133	200 x 100 x 35 mm
19-134	200 x 100 x 50 mm
19-135	230 x 130 x 50 mm
19-136	260 x 150 x 50 mm
19-137	270 x 235 x 50 mm
19-138	300 x 200 x 50 mm
19-139	325 x 275 x 50 mm



19-140
 205 x 105 x 35 mm



Round Metal Boxes and Medicine Cups



19-143 - 148

	Ø x H
19-143	75 x 60 mm
19-144	75 x 75 mm
19-145	100 x 60 mm
19-146	100 x 100 mm
19-146A	125 x 80 mm
19-147	125 x 125 mm
19-148	150 x 150 mm



19-149
25 cc



19-150
50 cc



19-151
20 cc
Medicine Spoon



19-152
Ø 75 x 12 mm
Tablet Tray



19-153
Ø 90 x 90 mm
Metal Cup



19-154
Ø 75 x 80 mm
Sputum Cup



Kidney Dish



19-155 - 157

19-155	170 x 100 x 35 mm
19-156	250 x 140 x 40 mm
19-157	275 x 150 x 45 mm



Hospital Wares



19-158 - 165

	Ø x H		
19-158	40 x 19 mm	0.05L	
19-159	61 x 30 mm	0.07L	
19-160	80 x 40 mm	0.14L	
19-161	116 x 50 mm	0.35L	
19-162	128 x 55 mm	0.45L	
19-163	147 x 65 mm	0.70L	
19-164	167 x 75 mm	1.10L	
19-165	187 x 85 mm	1.60L	



19-166 - 170

19-166	116 x 35 mm	0.30L
19-167	128 x 38 mm	0.40L
19-168	147 x 40 mm	0.50L
19-169	157 x 45 mm	0.75L
19-170	187 x 45 mm	1.00L



19-171
Ø 110 x 28 mm 0.15L



19-172
100 cc 0.1L



19-173 - 176

19-173	0.25L
19-174	0.50L
19-175	1.00L
19-176	2.00L



19-177
235 x 190 x 40 mm



19-178
Ø 220 x 70 mm



Hospital Wares



19-179
∅ 50 x 100 mm
Powder Pot



19-180
∅ 50 x 75 mm
Methot With Lid



19-181
∅ 50 x 75 mm
Methot Without Lid



19-182



19-183



19-184



19-185 - 186

19-185 ∅ 235 mm
19-186 ∅ 310 mm



Needle Cases



19-187
Sauerbruch
210 x 125 x 17 mm



19-188
Sauerbruch
210 x 125 x 17 mm



19-189
Instruments Tray



19-190
150 x 95 x 13 mm



19-191
150 x 95 x 13 mm



19-192
150 x 95 x 13 mm



19-193
Instruments Tray



19-194
Instruments Tray



19-195
150 x 95 x 11 mm



Storing Cases



19-199 - 209

19-199	230 x 130 x 50	mm
19-200	260 x 150 x 50	mm
19-201	275 x 235 x 50	mm
19-202	300 x 200 x 50	mm
19-203	325 x 275 x 50	mm
19-204	420 x 175 x 50	mm
19-205	230 x 130 x 75	mm
19-206	260 x 150 x 75	mm
19-207	300 x 200 x 75	mm
19-208	325 x 275 x 75	mm
19-209	420 x 175 x 75	mm



19-196
Deponette
245 x 135 x 35mm



19-197
Deponette
245 x 135 x 50mm



19-198
Deponette
245 x 135 x 60mm



Sterilizing Baskets / Trays



19-210 - 212

19-210	480 x 250 x 50	mm
19-211	520 x 250 x 75	mm
19-212	520 x 250 x 100	mm



19-219
(60 x 30 x 15 cm)
Nominal dimensions



19-213 - 218

19-213	240 x 240 x 50	mm
19-214	240 x 240 x 80	mm
19-215	240 x 240 x 100	mm
19-216	480 x 260 x 50	mm
19-217	520 x 260 x 80	mm
19-218	520 x 260 x 100	mm



Scissors with Tungsten Carbide Inserts



26-101
Standard



14,5cm
16,5cm
18,5cm



26-102
Standard



14,5cm
16,5cm
18,5cm



26-103
Standard



14,5cm
16,5cm
18,5cm



26-104
Standard



14,5cm
16,5cm
18,5cm



26-105
Standard



14,5cm
16,5cm
18,5cm



26-106
Standard



14,5cm
16,5cm
18,5cm



Scissors with Tungsten Carbide Inserts

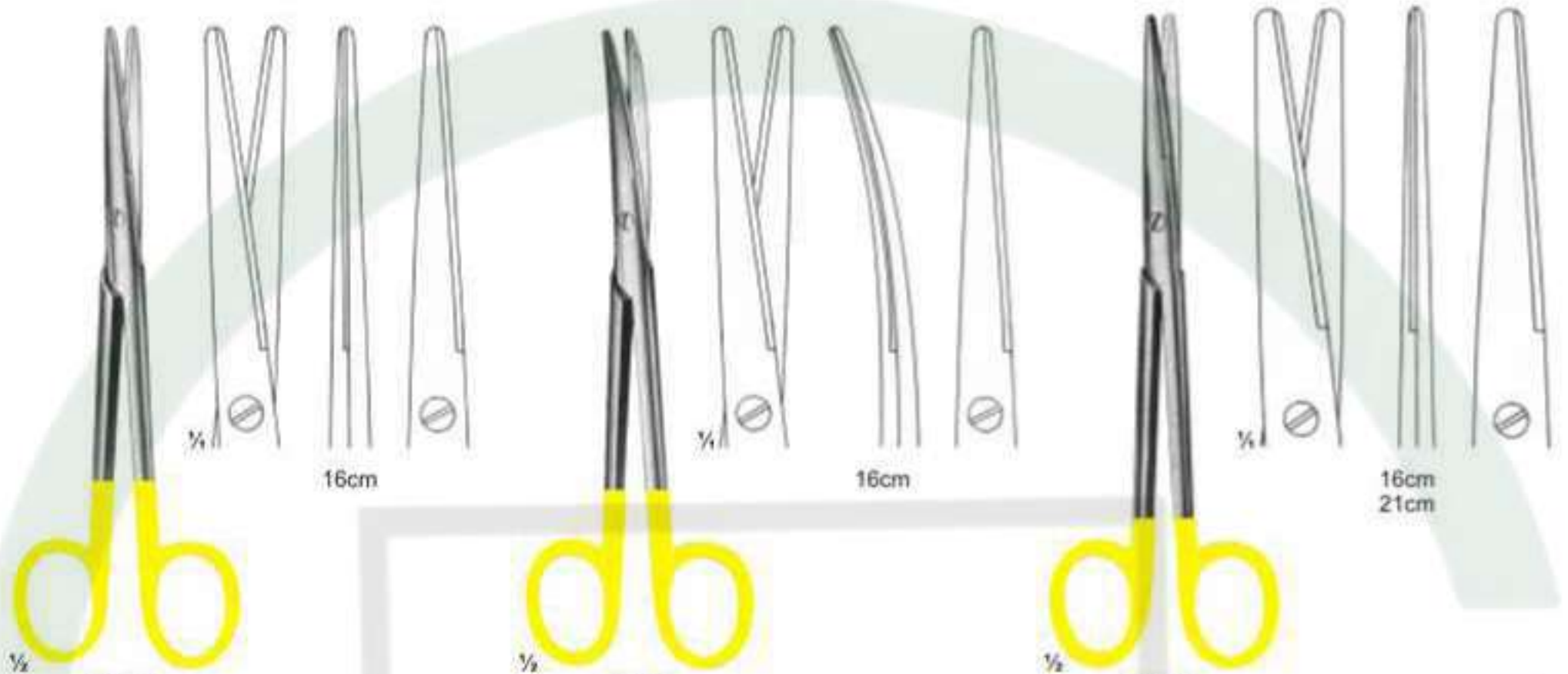

1/2
26-107
Mayo-Lexer

1/2
26-108
Mayo-Lexer

1/2
26-109
Lexer

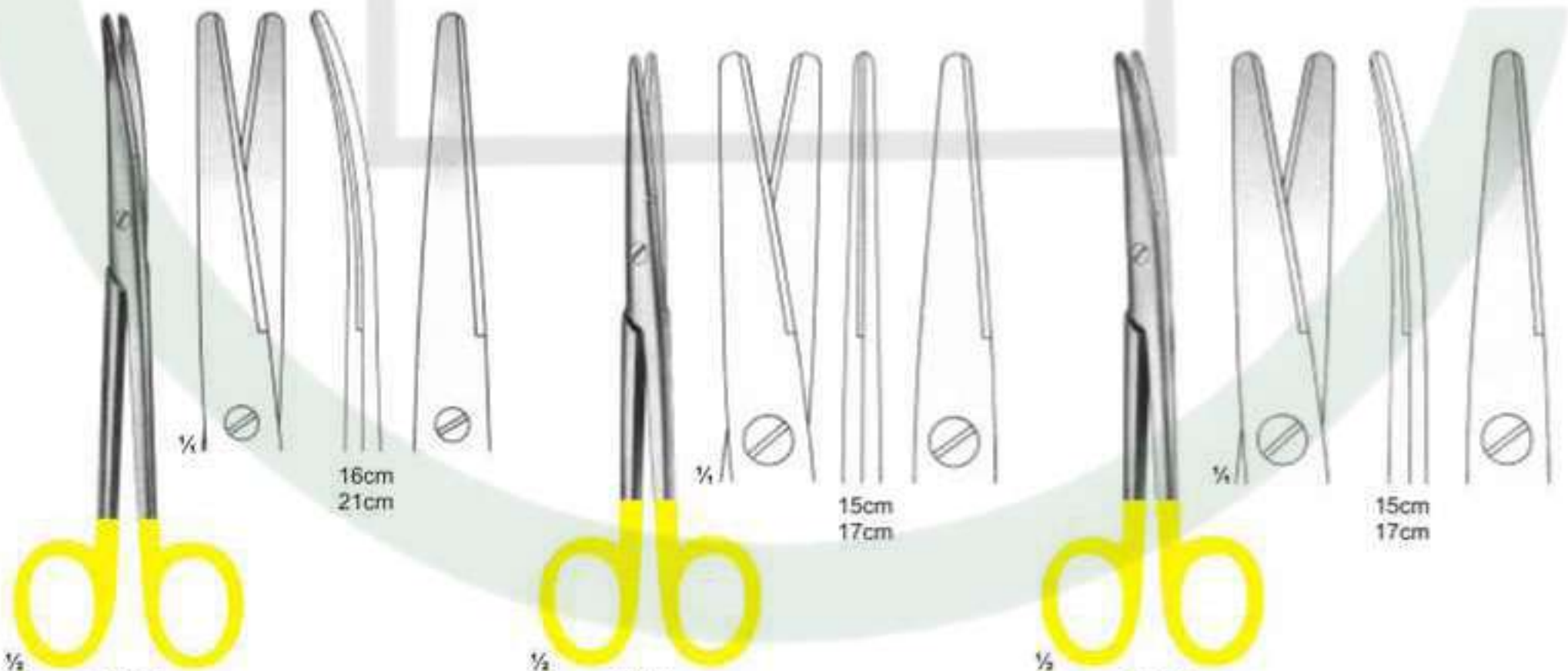

1/2
26-110
Lexer

1/2
26-111
Mayo-Stille

1/2
26-112
Mayo-Stille



Scissors with Tungsten Carbide Inserts



26-113
Metzenbaum

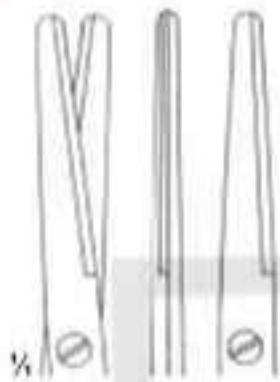

18cm
20cm
28cm
30cm

11,5cm
14,5cm
23,5cm
25,5cm



26-114
Metzenbaum



11,5cm 14,5cm
23cm 25cm



26-115
Metzenbaum



18cm 20cm
28cm 30cm



26-116
Metzenbaum-Fino

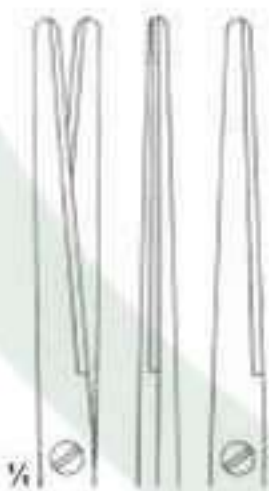

14cm 18cm 20cm
23cm 25cm 28cm



26-117
Metzenbaum-Fino

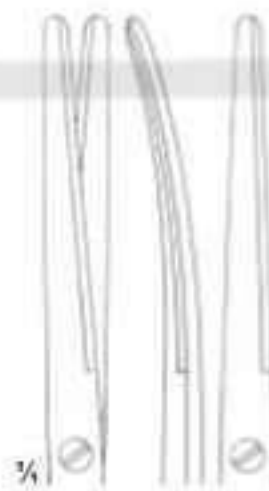

14cm 18cm 20cm
23cm 25cm 28cm



26-118
Metzenbaum-Fino



14cm 18cm
20cm 23cm



Scissors with Tungsten Carbide Inserts

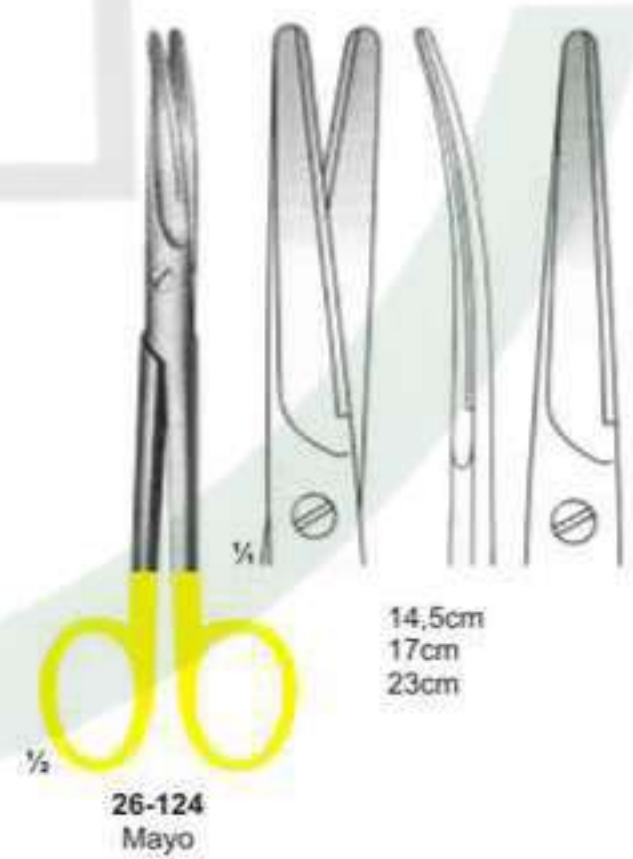
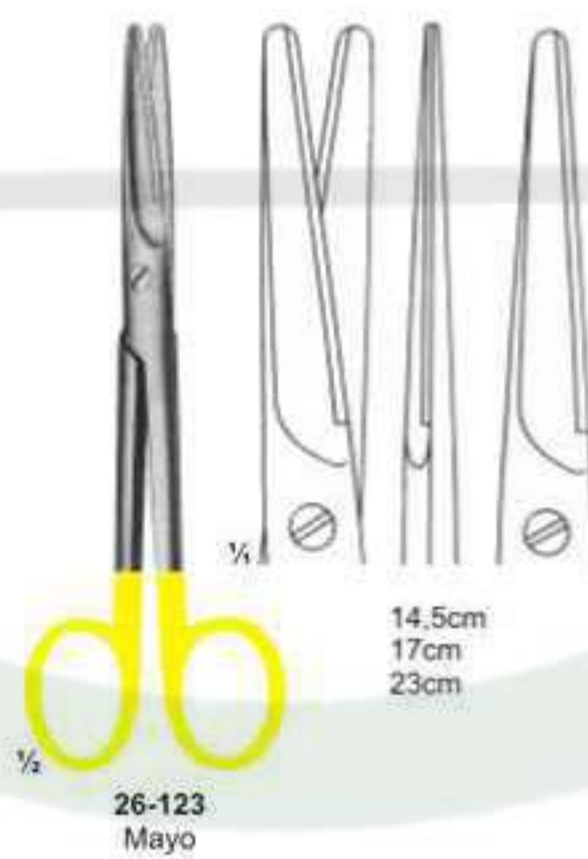
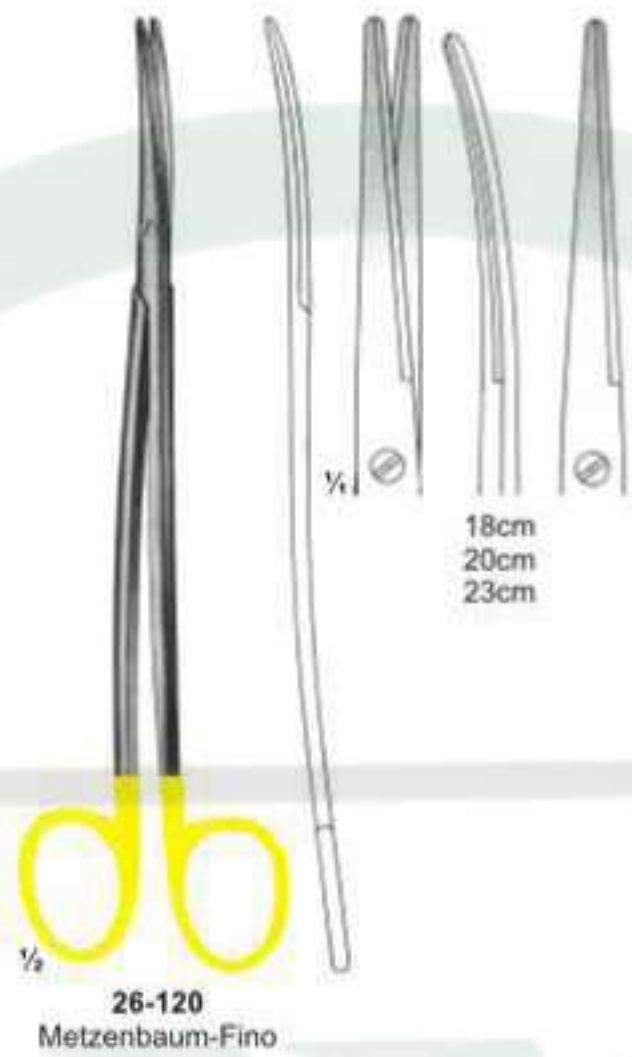
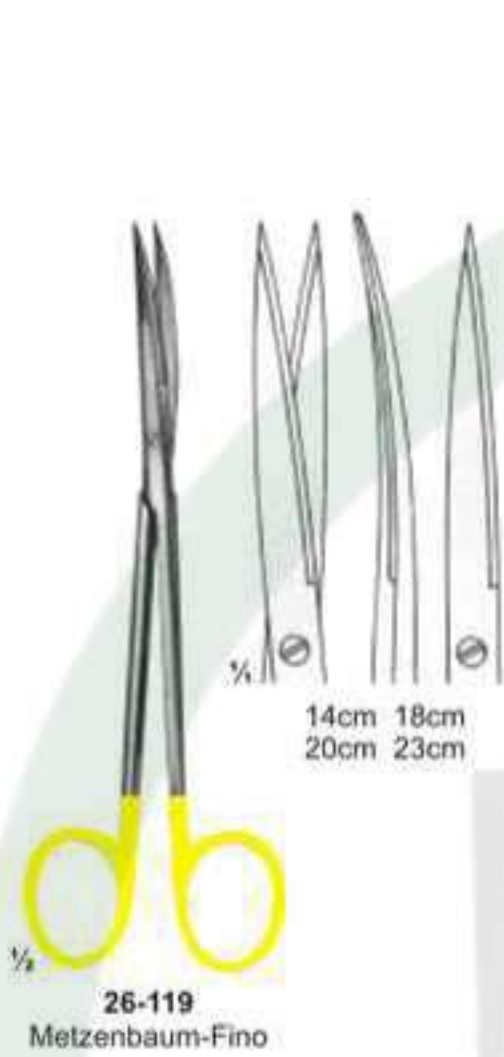



Scissors with Tungsten Carbide Inserts





Scissors with Tungsten Carbide Inserts





Scissors & Dissecting Forceps with Tungsten Carbide Inserts



26-136
Universal
12cm



26-137
Ligature Scissors
1 Black & 1 Goldplated ring



26-138
Adson



26-139
Cushing
17.5cm



26-140
Cushing
18cm



26-141
Cushing-Taylor
18cm



26-142
Dissecting Forceps
15cm



26-143
Semken
15cm



Dissecting Forceps and Needle holders with

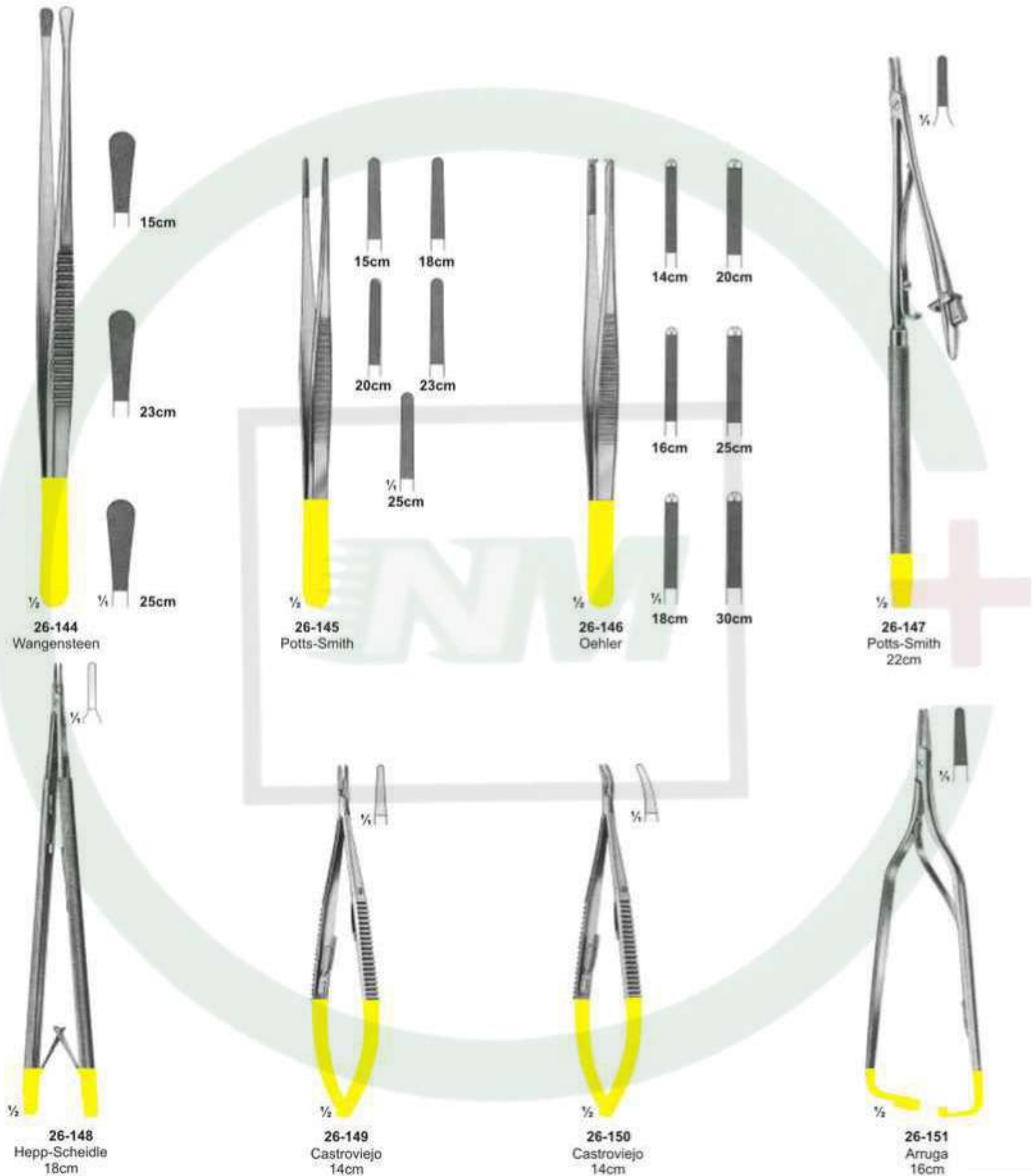



Needle holders with Tungsten Carbide Inserts

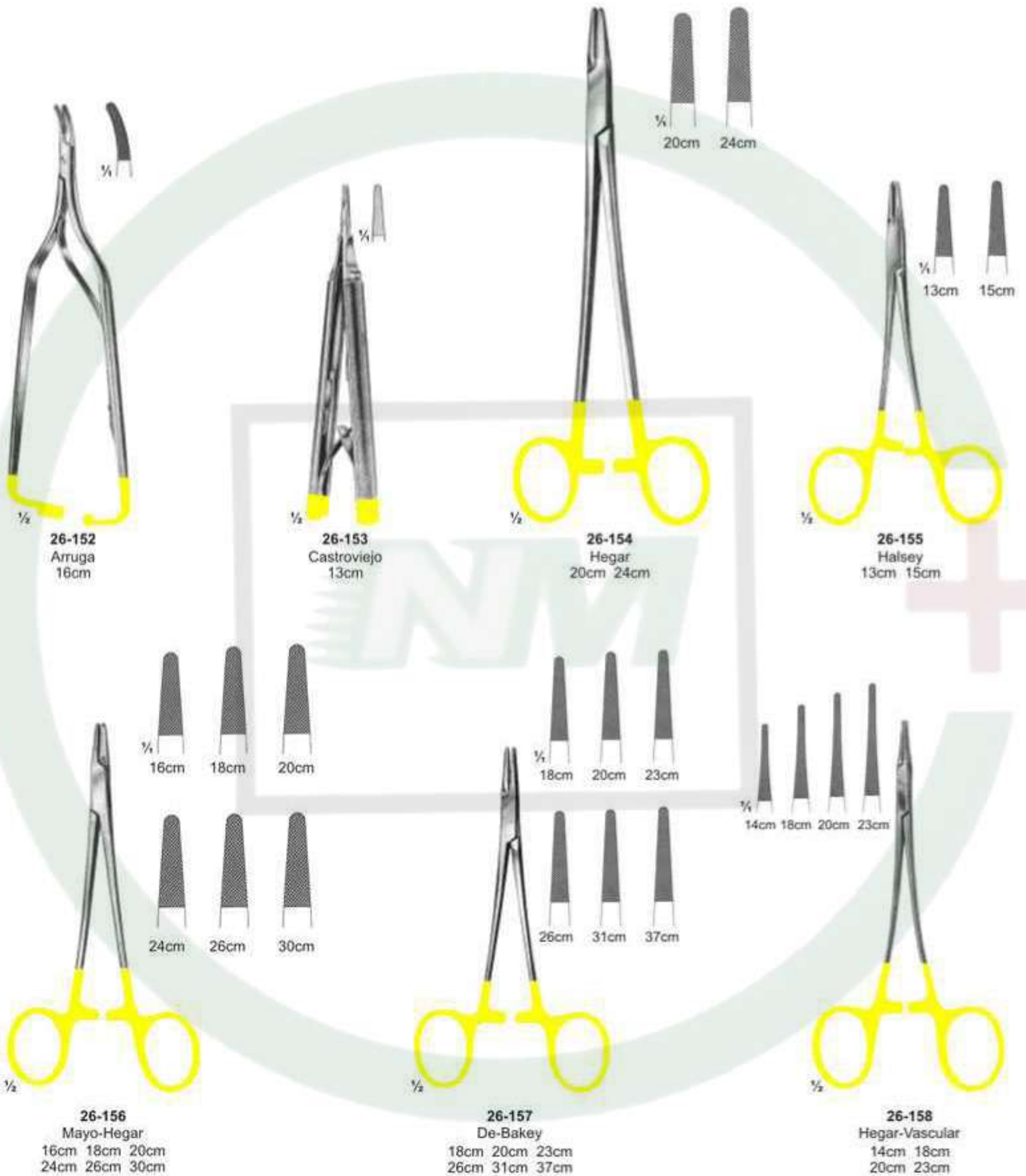



Needle holders with Tungsten Carbide Inserts



26-159
Bozemann-Wertheim
20cm 24cm 26cm

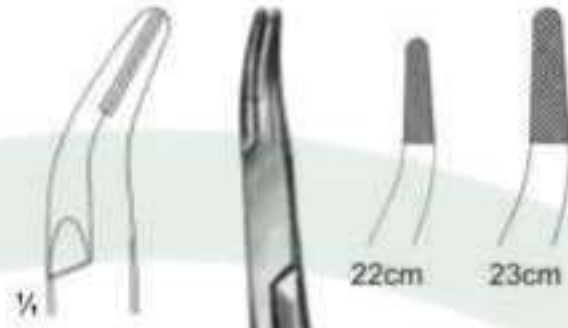

26-160
Stratte
22cm 23cm



26-161
Ryder
13cm 15cm 18cm
20cm 23cm 26cm



26-162
Ryder-Vascular
13cm 15cm 18cm
20cm 23cm 26cm



26-163
Martin
15cm 17cm 20cm



26-164
Sarot
18cm 20cm 26cm



Needle holders with Tungsten Carbide Inserts

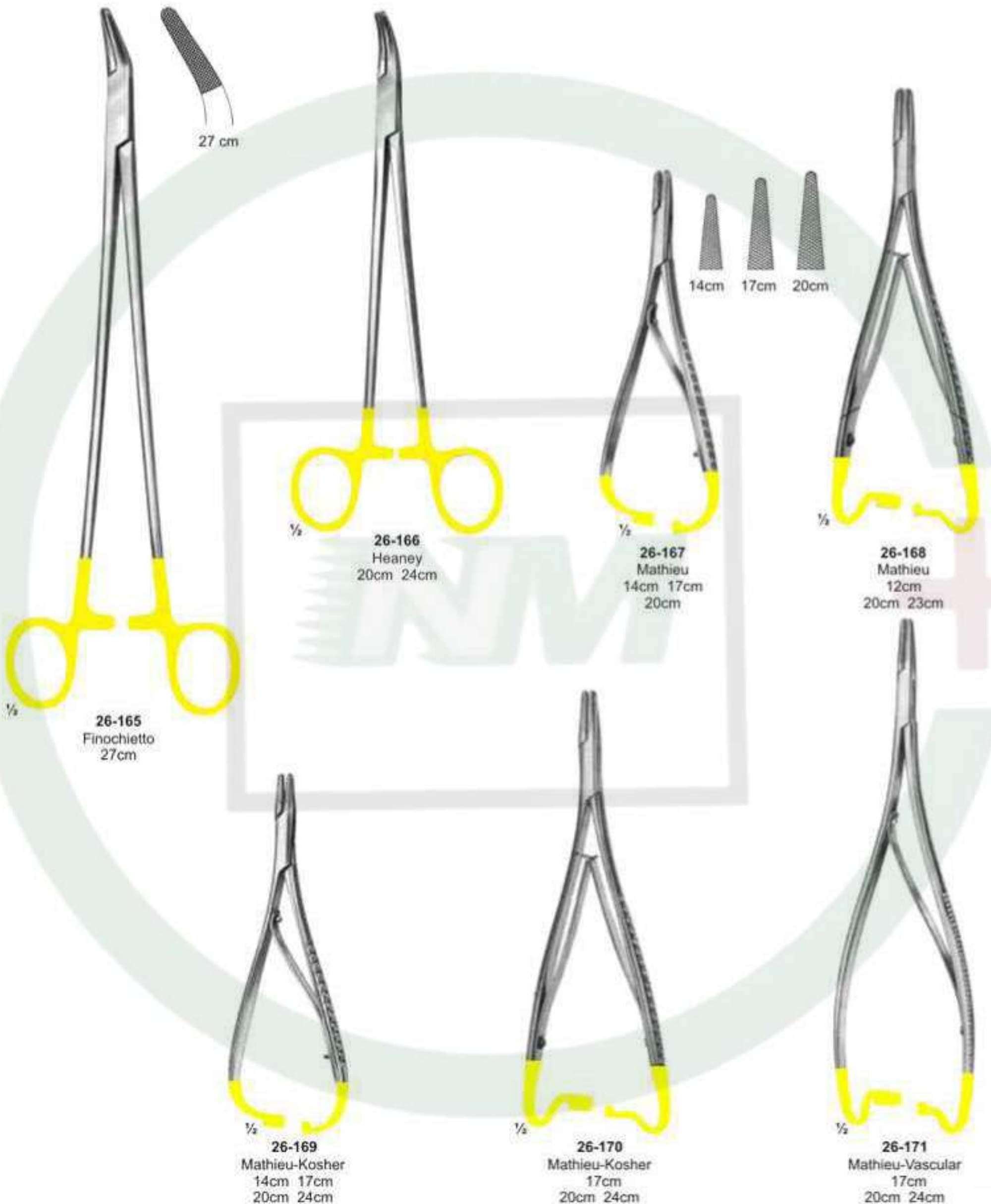



Needle holders with Tungsten Carbide Inserts



1/2
26-172
Mathieu-Ryder
17cm
20cm 24cm



1/2
26-173
Lichtenberg
20cm



1/2
26-174
Langhals
20cm 25cm



1/2
26-175
Lichtenberg
20cm 25cm



1/2
26-176
Luehty-Beck
20cm 25cm



1/2
26-177
Luehty-Beck
20cm 25cm



1/2
26-178
Langebeck
18cm
20cm 23cm



1/2
26-179
Langebeck-beck
18cm
20cm 23cm



Wire Cutting Plier With T.C. Inserts



26-180
TOENNIS
Elastic pattern for
dura-or intestinal suture
180 mm



26-181
Cutting Plier
12 cm



26-182
MULLAR CLAUS
22 cm



26-183
Plier
17.5 cm



Alphabetical Index

A	
ABRAHAM, tonsil knife	13
ADSON, forceps	33
ADSON, forceps	37
ALLIS, artery traction forceps	47
ALLIS, intestinal grasping forceps	86
ALY, aesthesiometer	01
AMPUTATING KNIVES	12
ANDREW, tongue depressor	04
ANESTOPHON, stethoscope	02
ARRUGA, forceps	37
ARRUGA, needle holder	61
ASCH, biopsy curettes	112
AUFRIEHT, rasps	138
AYRE, cone knife, 235mm	13
ADSON - BROWN, Tissue Forceps	39
ADSON, Haemostatic Forceps	52
ANGLE, Wire Cutters Cutting Scissors	151
B	
BABCOCK, intestinal grasping forceps	86
BABY-ALLIS, artery traction forceps	47
BACKHAUS, towel clamps	48
BACKHAUS-KOCHER, towel clamps	48
BAILEY, rib spreaders	128
BAKES, gall duct dilators	95
BALFOUR, abdominal retractors	85
BALFOUR-BABY, abdominal retractors	84
BANE-HARTMANN, bone rongeurs	144
BARTH, bone curettes	139
BABY-MOSQUITO, Haemostatic Forceps	51
BABY-ROUX, Retractors	73
BABY-SENN-MILLER, Retractors	73
BEEBE wire scissor	29
BEER, cilia forceps	42
BENGOLEA, delicate forceps	50
BERGER, biopsy forceps	115
BERLINER, percussion hammer	01
BENDING PLIERS, Wire Holding forceps	150
BERTILLON, Examination & Measuring Instruments	10
BIEMER, vein scissor	16
BISHOP-HARMON, forceps	37
BIEMER, Suction Instruments	158
BLAKE, gall stone forceps	96
BLUMENTHAL, bone rongeurs	144
BONNEY, tissue forceps	41
BOSE, tracheal hooks	119
BOWLES, stethoscope	02
BOYS-ALLIS, artery traction forceps	47
BOZEMANN, dressing forceps	108
BOYNTON, Needle Holders	47
BRAUN, artery traction forceps	107
BRAUN, uterine probes	28
BRAUN-STADLER episiotomy scissor	31
BRAUN-STADLER, bandage scissors	102
BRIESKY, vaginal specula	66
BRODIE, probes	34
BROPHY, dissecting forceps	04
BRUENINGS, tongue depressor	13
BRUNINGS, tonsil knife, 215mm	76
BRUNNER, retractors	126
BRUNNER, rib shears	31
BRUNS, plaster scissor	64
BRYANT, sponge forceps	43
BROPHY, Tissue Forceps	38
BROWN, Tissue Forceps	39
BUCHS, retractors	75
BUCHWALD, tongue depressor	04
BUCK, neurological hammer	01
BUMM, ovum forceps	230
BUCK, Ear Curettes	110
C	
CASPAR, retractor	75
CASPAR, Micro scissor 115mm	16
CASTROVIEJO, tissue forceps	37
CASTROVIEJO, micro spring scissor	15
CASTROVIEJO, needle holder	61
CASTROVIEJO, eye scissor 110mm	15
CASTROVIEJO, eye scissor 115mm	15
CATLIN, amputating knife 160mm	12
CALIPER, Examination & Measuring Instruments	10
CARREL, Haemostatic Forceps	51
CARROLL, Examination & Measuring Instruments	10
CASPAR, Rongeurs	133
CASPAR, Rongeurs	134
CASTROVIEJO, Examination & Measuring Instruments	10
CHAPUT, artery traction forceps	47
CLOWARD, lamina Spreaders	83
CLAUS PLIER, Wire Cutting Plier With T.C. Inserts	187
CLAUS PLIER, Wire Cutting Plier With T.C. Inserts	187
COAKLEY, antrum trocars	100
COLLIN, intestinal grasping forceps	86
COLLIN, rib shears	126
COLLIN, sponge and dressing forceps	44
COLLIN, tongue forceps	05
COLLIN, vaginal spatula	101
CONE KNIFE 235mm11	13
CONVERSE, fine wound retractor	69
COOLEY, multi purpose clamps	122
COTTLE, retractors	71
COTTLE, nasal scissor	25
COTTLE, fine wound retractor	69
COTTLE, mallets	140
COLLIN, Examination & Measuring Instruments	10
COLLIN, Intestinal Grasping Forceps	46
COLLIN, Retractors	73
COLLIN-HARTMANN, Retractors	73
COTTLE, Forceps, Bayonet - Shaped	40
COTTLE, Nasal Specula	91
CRILE, Haemostatic Forceps	52
CRILE, Haemostatic Forceps	52
CRILE, Retractors	73
CUTTING PLIER, Wire Cutting Plier With T.C. Inserts	187
CRAFOORD, haemostatic forceps	50
CRILE, needle holder	63
CUSCO, vaginal specula	101
CUSHING, wound and vein retractor	71
CUSHING, dissecting forceps	34
CUSHING-KOCHER, retractors	71
CZERNY, gall stone forceps	96
CZERNY, retractors	72



Alphabetical Index

D		F	
DAVIDSON, scapula retractors	77	FARABEUF, Retractors	73
DAVIS, vascular spatulas	120	FEILCHENELD, splinter forceps	42
DANDY, Haemostatic Forceps	51	FERGUSSON, haemorrhoidal forceps	93
DE BAKEY, forceps	36	FERGUSSON, suction instrument	163
DE BAKEY, anastomosis clamps	89	FERGUSSON-ACKLAND, mouth gag	05
DE BAKEY, anastomosis clamps	125	FINOCHIETTO, forceps	58
DE BAKEY, arteriotomy scissor	22	FINOCHIETTO, rib spreader	127
DE BAKEY, vana cava clamps	123	FINSEN, tracheal hooks	119
DE BAKEY, multi purpose clamps	122	FIBER OPTIC, laryngoscopes	09
DE BAKEY, retractors	82	FINGER NAIL DRIL, Finger Nail Instruments	155
DE BAKEY, atraumata	121	FINGER RING SAW, Finger Nail Instruments	155
DEAN, nasal and tonsil scissor	25	FINSTERER, Suction Instruments	161
DEAVER, retractors	77	FLAT-NOSED PLIERS, Wire Holding forceps	150
DEAVER, surgical scissor (flat lock)	21	FOERSTER-BALLENGER, Tissue Grasping Forceps	45
DE-BAKEY, bulldog clamps	49	FORCEPS, Finger Nail Instruments	155
DEJERINE, percussion hammer	01	FOREGGER, laryngoscopes	09
DELICATE DISSECTING FORCEPS	33	FOMON, nasal scissor	19
DELICATE SCISSORS, blunt points	19	FORD-BOWLES, stethoscope	02
DELICATE SCISSORS, sharp points	18	FOWLER, tonsil knife	13
DELICATE SCISSORS, sharp points	19	FRANCKE, blood lancet	06
DENHARDT, mouth gag	05	FRAZIER, fine wound retractor	69
DENIS-BROWENE, intestinal forceps	41	FRAZIER, suction instruments	163
DERRA, multi purpose clamps	122	FREER, fine wound retractor	69
DESCHAMPS, ligature needles	65	FREER, vascular spatulas	120
DESJARDINS, gall duct forceps	95	FRENZEL, tongue depressor	04
DESJARDINS, gall stone forceps	96	FRICKE, haemostatic forceps	56
DESJARDINS, gall stone scoops	95	FRITSCH, retractor	79
DESMARRES, wound and vein retractors	71		
DEMEL, Cerclage Instruments	148	G	
DIAGNOSTIC SETS	07	GALLAHER, rasp	126
DICK, vaginal clamps and compression forceps	59	GELPI, special retractors	82
DIEFFEBACH, bulldog clamps	49	GELPI, vaginal retractors	105
DINGMANN, bone holding forceps	142	GERALD, dissecting forceps	34
DISSECTING KNIVES	11	GIERTZ-STILLE, rib shears	126
Dissection Instruments	164	GILL, tissue forceps	37
Dissection Instruments	165	GILL-HESS, tissue forceps	37
Dissection Instruments	166	GILLIES, fine wound retractor	69
DITTEL, metal bougies	80	GILLIES, needle holder	63
DOYEN, abdominal retractors	79	GLOVER, bulldog clamp	49
DOYEN, intestinal clamps	87	GLUCK, rib shears	126
DOYEN, ovum forceps	230	GOOD, tonsil scissors	25
DOYEN, probes	66	GORNEY, suction instruments	163
DOYEN, towel clamps	48	GOSSET, abdominal retractors	84
DOYEN, vaginal specula	104	GRAEFE, fine wound retractor	69
DUROGRIP, Wire Holding forceps	149	GRAVE, vaginal specula	102
DUROTIP, Cutting Pliers	152	GROSS, dressing forceps	43
DUROTIP, Cutting Pliers	153	GUEDEL-NEGUS, laryngoscope	08
DUROTIP, Wire Cutters Cutting Scissors	151	GUTHRIE, fine wound retractor	69
DUVAL-COLLIN, Intestinal Grasping Forceps	46	GUYON, kidney clamps	97
DUPLAY, sponge and dressing forceps	43	GERALD, Tissue Forceps	38
DUVAL, intestinal forceps	41	GILLIES, Tissue Forceps	38
		GOLDSMITH, Nasal Specula	91
E		GRAEFE, Tissue Forceps	39
EISELSBERD, needle holder	63	GRAEFE, Tissue Forceps	39
ELSCHING, forceps	37	GRUENWALD, Forceps, Bayonet – Shaped	40
ENGL.MOD, towel clamps	48		
EPPENDORF, biopsy forceps	115	H	
ESMARCH, cloth and plaster scissors	31	HALLE, vascular spatulas	120
EISELSBERG-MATHIEU, Needle Holders	64	HALSTED-MOSQUITO, haemostatic forceps	50
EXTRACTION PLIERS, Wire Holding forceps	150	HARTMANN, intestinal clamps	87



Alphabetical Index

HARVEY, plate scissors	29	KELLY, tissue grasping forceps	44
HAJEK-KOFLER, Punches	130	KERN-LANE, bone holding forceps	143
HALSTED, Haemostatic Forceps	52	KERRISON-JACOBY, punches	129
HALSTED-MOSQUITO, Haemostatic Forceps	51	KERSTING, anastomosis forceps	89
HARTMANN, Ear Polypus Forceps	112	KELLY, Haemostatic Forceps	51
HARTMANN-HALLE, Nasal Specula	91	KERRISON, Punches	130
HARTMANN-HERZFELR, Ear Polypus Forceps	112	KILLIAN, bone shear	26
HARTMANN-HOFFMAR, Ear Polypus Forceps	112	KILLIAN, rectal spatula	90
HARTMANN-WULLSTEIN, Ear Polypus Forceps	112	KILNER, fine dissecting scissors	22
HARVEY, Wire Cutters Cutting Scissors	151	KILNER, fine wound retractor	69
HEANEY, needle holder	62	KILNER, dissecting scissor	22
HEGAR, needle holder	62	KILLIAN, Nasal Specula	90
HEGAR-OLSEN, needle holder	63	KIRSCHNER, Cutting Pliers	154
HEGER, uterine dilators	106	KIRSCHNER, Wire Extension	147
HEISS, haemostatic forceps	50	KOCHER, Haemostatic Forceps	52
HEISS, dressing forceps	58	KOCHER, Haemostatic Forceps	54
HEISTER, mouth gag	05	KOCHER-OCHSNER, Haemostatic Forceps	55
HENING, plaster spreader	157	KLIMA ROSEGGER, trocars	100
HERGET, biopsy forceps	113	KOCHER, retractor	71
HERTZLER, abdominal retractors	84	KOCHER, bladder retractors	99
HERTZLER, rib spreaders	127	KOCHER, bone retractor	74
HESS, tissue forceps	37	KOCHER, retractors	75
HEYMANN-KNIGHT, scissors	25	KOLLE, blood lancet	06
HEYWOOD-SMITH, ovum forceps	109	KONIG, elevators	135
HEYWOOD-SMITH, sponge holding forceps	44	KONIG, raspatories	137
HEYWOOD-SMITH, tongue forceps	05	KONISATION SMESSER, retractors	57
HOLLOW NEEDLE, Suction Instruments	159	KRAUSE, biopsy tip	115
HOUSE, Suction Instruments	161	KRISTELLER, vaginal specula	102
HUBER, biopsy forceps	115	KRISTELLER, vaginal specula	103
HUNT, tumor & vessel forceps	32	KRONECKER, suture instruments	65
HUNTER, splinter forceps	42	KRONLEIN, haemostatic forceps	56
I		KUMMEL, intestinal spatula	80
INGE, lamina spreaders	83	L	
INTEROSSEOUS, cartilage knife	12	LABORDE, tracheal dilators	119
IVES-FANSLER, anosscopes	92	LAHEY, artery traction forceps	47
J		LAHEY, gall duct forceps	94
JACKSON BURROWS, retractors	82	LANE TRETOWAN, bone levers	136
JACOBSON, bone curettes	139	LANE, bone holding forceps	143
JACOBSON, needle holder	61	LANE, bone levers	136
JAEGAR, fine wound retractor	69	LANE, tissue forceps	41
JAMESON, dissecting scissor	22	LANE, towel clamps	48
JAMESON, needle holder	62	LANGE-HOHMANN, bone levers	136
JANSEN, bone curettes	139	LANGENBACK, bone levers	135
JANSEN, bone rongeurs	144	LANGENBECK, with triangle handle	70
JOHNS-HOPKING, bulldog clamps	49	LANGENBECK, flap knife	12
JOLL (FRIEDMAN), retractors	82	LARYNGEAL MIRRORS	06
JOLL, vaginal retractors	105	LAWRENCE, ligature forceps	58
JONES, towel clamps	48	LANDOLT, Suction Instruments	160
JOSEPH, bone file	138	LANDOLT, Suction Instruments	161
JOSEPH, dura and skin retractor	69	LANGENBECK, Ear Curettes	110
JOSEPH, raspatories	137	LEBSCHKE, rib shears	126
JUDD-MASSON, bladder retractors	99	LEGUEU, bladder retractors	99
JANSEN, FORCEPS, Bayonet - Shaped	40	LEKSELL-STILLE, bone rongeurs	145
K		LERICHE, intestinal spatula	80
KADER, intestinal spatula	80	LEWIS, bone file	138
KALT, needle holder	61	LISTER, bandage scissor	30
KELLY, ovum forceps	109	LISTER, cloth scissor	30
KELLY, anosscopes	92	LISTER, sponge forceps	43
		LISTON, bone cutting forceps	146



Alphabetical Index

LOCKHART-MUMMERY, probes	66	MULLER, dura and skin retractor	69
LOCKWOOD, Intestinal Grasping Forceps	46	MURPHY, head band	03
LUCAE, FORCEPS, Bayonet – Shaped	40	MUSEUX, tissue grasping forceps	47
LUER, Retractors	73	N	
LOCKLIN, delicate scissor	25	NASAL SCISSORS	25
LOPEZ-REINKE, suction instruments	163	NAUJOKS wire scissors	29
LOWER, gall duct forceps	94	NAIL SPLITTING, Finger Nail Instruments	155
LOWMAN, bone clamps	143	NEEDLE HOLDER, for micro surgery	48
LOWMAN-GERSTER, bone clamps	143	NEGUS, tonsil forceps	57
LOWMAN-HOGLUND, bone clamps	143	NELATON, probes	66
LUCAS, gouges	141	NELSON, lung dissecting forceps	41
LUER-KORTE, gall stone scoops	80	NISSEN, gall duct forceps	94
LURE, bone rongeurs	144	NOTO, ovum forceps	109
		NOTO, sponge holding forceps	44
M		NOVAK-SCHOECKAERT, biopsy curettes	111
MAGILL, laryngoscope	07	NOYES, micro spring scissor	15
MALTZ, rasps	138	O	
MANNERFELT, osteotomes	141	OLIVECRONA, dura scissors	24
MANNERFELT, retractors	70	OLIVECRONA, trigeminal knife	13
MARTIN, uterine probes	107	OTOSCOPE SETS	07
MARTINI, bone curettes	139	OTOSCOPE, Diagnostic Sets	07
MASING, retractors	71	P	
MASSON, needle holder	62	PARTSCH, raspatories	137
MASSON-LUETHY, needle holder	62	PARTSCH, gouges	141
MATHIEU, retractors	72	PARTSCH, raspatories	137
MAYO, dissecting scissors	23	PAYR, pylorus clamps	86
MAYO, uterine probes	107	PEAN, haemostatic forceps	57
MAYO-HARRINGTON, dissecting scissors	23	PEAN, haemostatic forceps	51
MAYO-NOBLE, dissecting scissors	23	PEAN, kidney clamps	97
MAYO-STILLE, dissecting scissors	23	PEDERSON, vaginal specula	102
MARTIN, Nasal Specula	90	PEET, splinter forceps	42
MATHIEU, Needle Holders	64	PELKMANN, uterine dressing forceps	108
MATHIEU-STILLE, Needle Holders	64	PERKINS, self retaining retractors	81
MC INDOE, forceps	34	PIERCE, trocars	100
MC KENTY, raspatories	137	PINARD, wooden stethoscope	02
MEAD, mallets	140	PLESTER, retractors	81
MC INDOE, Tissue Forceps	38	PLESTER, suction instruments	163
MCINTOSH, laryngoscopes	09	POOL, suction instruments	162
MEDIUM, Dissecting Forceps	35	POTTS-SMITH, cardiovascular scissor	24
MICRO-HALSTED, Haemostatic Forceps	51	PROBES	67
MILLIN, Needle Holders	64	PARKER, Retractors	73
MICHEL, laryngeal mirrors	06	PEAN, Haemostatic Forceps	52
MICRO SCISSORS, laterally angled	17	PEAN, Haemostatic Forceps	53
MICRO-ADSON, forceps	33	PEAN, Haemostatic Forceps	54
MICRO-ADSON, forceps	37	PENNINGTON, Tissue Grasping Forceps	45
MIDDELDORPF, retractors	75	PROVIDENCE-HOSPITAL, Haemostatic Forceps	51
MIKULICZ, tissue forceps	57	Q	
MIKULICZ, intestinal spatula	80	QUERVAIN, bone levers	113
MIKULICZ, retractors	78	R	
MILLER, laryngoscope	08	RABINER, neurological hammer	01
MILLIN, bladder retractors	99	RANDALL, biopsy curettes	111
MIXTER, ligature forceps	58	RANDALL, kidney stone forceps	98
MOD.USA, plaster spreader	127	RECAMIER, uterine scoops	116
MORRIS, anastomosis clamps	89	REYNOLDS, dissecting scissors	22
MOYNIHAN, haemostatic forceps	57	RICHTER, vaginal retractors	105
MOYO-HEGAR, needle holder	62	ROCHESTER-CARMALT, haemostatic forceps	57
MOD. WIEN, Nasal Specula	91	ROEDER, towel clamps	48
MOLTGEN, Examination & Measuring Instruments	10		
MULLAR, Wire Cutting Plier With T.C. Inserts	187		
MULLER LIGATURE FORCEPS	49		
MULLER VESSEL CLIPS	49		



Alphabetical Index

ROUX, retractors	72
RUDD, haemorrhoidal ligator	93
RUMEL, dissecting forceps	58
RUSS-MODELL, tissue forceps	41
ROHRSCHEIDER, needle holder	61
ROLLET, dura and skin retractor	69
ROSER KONIG, mouth gag	05
RAMPLEY, Tissue Grasping Forceps	45
RANKIN, Haemostatic Forceps	52
REILL, Cutting Pliers	152
REPLACEMENT LAMP, laryngoscopes	09
ROCHESTER-OCHSNER, Haemostatic Forceps	54
ROCHESTER-PEAN, Haemostatic Forceps	53
ROSE, Retractors	73
ROUND PLIERS, Wire Holding forceps	150

S

SAENGER, ovum forceps	118
SAMII, tumor grasping forceps	32
SATINSKY, vena cava scissors	24
SAUPE, cilia forceps	42
SCALPEL HANDLES	14
SCHAAF, cilia forceps	42
SCHAEDEL, towel clamps	48
SCHEINMANN, biopsy forceps	115
SCHIMMELBUSCH, ether mask	05
SCHMID, vascular spatulas	120
SCHOEMAKER-LOTH, needle holder	63
SCHOENBORN, retractors	71
SCHRODER, uterine scoops	116
SCHUMACHER, rib shears	126
SCHUMACHER, umbilical scissors	28
SCHUMASHER, biopsy forceps	114
SCOVILLE-RICHTER, retractors	67
SEGOND, myotome	13
SEIDL, vaginal specula	102
SEIDL-DBP, biopsy forceps	114
SELLORS, rib spreaders	128
SEMKEN, dissecting forceps	34
SEMKEN, tissue forceps	37
SENN-MILLER, Retractors	73
SEUTIN, plaster scissor	31
SHAPLEIGH, Ear Curettes	110
SIMON, uterine scoops	116
SIMPLEX, tongue depressor	04
SIMPSON, uterine probes	107
SIMPSON-BRAUN, obstetrics forceps	117
SIMS, gynaecology scissors	27
SIMS, vaginal specula	102
SIMS, rectal specula	90
SIMS, uterine probes	107
SMOOTH JAWS FORCEPS	34
ST.MARTIN, tissue forceps	37
STEMBERG, tongue depressor	04
STIEGLITZ, splinter forceps	42
STILLE, bone rongeurs	145
STILLE-AESCLAP, plaster shears	156
STILLE-RUSKIN, bone rongeurs	145
STRACK, wire scissor	29
STRASSBURGER Tissue forceps	41
STANDARD, Dissecting Forceps	35
STANDARD, Tissue Forceps	39

STERBERG, Retractors	
STRULLY, cardiovascular scissors (pointed)	24
SUCTION INSTRUMENTS	162
SURGICAL SCISSORS, incision	21
SURGICAL SCISSORS, serrated	20
SURGICAL SCISSORS, slender type	20
SURGICAL SCISSORS, standard	20
SURGICAL SCISSORS, standard	20
SUTURING INSTRUMENT SET	68
SYSTRUNK, nail splitting scissors	21
SPENCER-WELLS, Haemostatic Forceps	
SYSTRUNK, Finger Nail Instruments	

T

TAKAHASHI, rongeur	112
TAYLOR, percussion hammer	01
TAKAHASHI, Rongeurs	132
THOREK, cardiovascular scissors	24
THORPE, corneal forceps	33
TIECK-HALLE, Nasal Specula	90
TOENNIS, Wire Cutting Plier With T.C. Inserts	187
TOWNLEY, Examination & Measuring Instruments	10
TOBOLD, tongue depressors	04
TOENNIS ADSON, dissecting scissors	22
TOENNIS, dissecting scissors	22
TOENNIS, fine wound retractor	69
TOENNIS, vascular spatulas	120
TOENNIS, needle holder	63
TRELAT, raspatories	137
TRIGEMINAL KNIFE	13
TROCARS	100
TROEMNER, percussion hammer	01
TROUSSEAU, tracheal dilators	119
TROCAR, Suction Instruments	159
TROELTSCH, FORCEPS, Bayonet - Shaped	40
TUFFIER, rib spreaders	127
TUTTLE, lung dissecting forceps	41

U

UMBILICAL CORD SCISSORS	28
UNIVERSAL BANDAGE SCISSORS	30
UNIVERSAL TROCARS	100
US-ARMY, retractors	72

V

VANNAS, micro spring scissors	15
VERNIER, Examination & Measuring Instruments	10
WISE GRIP, Wire Holding forceps	150
VOLKMANN, bone curettes	139
VOLKMANN, bone retractors	74



Alphabetical Index

W

WANGENSTEEN, needle holder	62
WARTENMERG, pinwheel	01
WAGNER, Rongeurs	134
WAUGH, Tissue Forceps	38
WEBER, anastomosis clamps	124
WECKER, eye scissors	15
WEIL-BLAKESLEY, rongeurs	112
WEITLANER, self retaining retractors	81
WERTHEIM, gynaecology scissors	27
WERTHEIM, clamps and forceps	59
WERTHEIM-CULLEN, vaginal clamps	60
WIEDER, tongue depressor	04
WEIL-BLAKESLEY, Rongeurs	132
WILLIGER, bone curettes	139
WILLIGER, elevators	135
WILLIGER, raspatories	137
WINTER, ovum forceps	118
WILDE, Forceps, Bayonet – Shaped	40
WOLFF, plaster breakers	157
WULLSTEIN, retractors	81
WULLSTEIN, Suction Instruments	160

Y

YASARGIL, needle holder	61
YASARGIL, tumor grasping forceps	32
YASARGIL-SAMII, tumor grasping forceps	32
YASARGIL, Suction Instruments	160
YASARGIL, Suction Instruments	161
YASRGIL, micro scissors	17
YEOMAN, biopsy forceps	113
YOUNG, tongue forceps	05
YOUNG- HRYNTSCHAK, Needle Holders	64
YOUNG-MILLIN, Needle Holders	64

Z

ZENKER, ligature	58
ZENKER, retractors	77
ZIEGLER, head band	03
ZIEGLER, head mirror	03



NAKSHM SURGICAL



Rani chak, Bhoth, Sialkot, Pakistan



+92 (321) 711 5605



nakshmsurgical@gmail.com



www.facebook.com/nmsurgico



www.instagram.com/nmsurgico



www.nakshm.Com